

### Typical Applications

The HMC296MS8 / HMC296MS8E is ideal for:

- Miniature Basestations
- PCMCIA
- Portable Wireless
- WirelessLAN

### Features

- Input IP3: +24 dBm @ +11 dBm LO
- LO Range = +3 to +11 dBm
- Conversion Loss: 7 dB
- LO/RF Isolation: 40 dB

### Functional Diagram

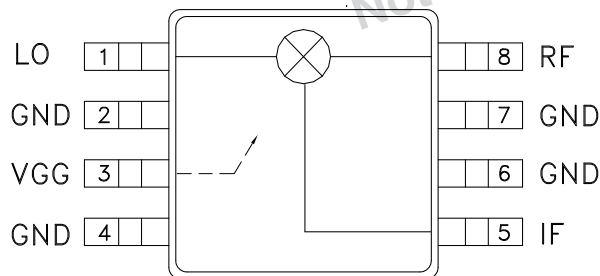

### General Description

The HMC296MS8 & HMC296MS8E are low LO drive, high IP3 double-balanced FET mixers in 8 lead plastic surface mount MSOP packages. This MMIC mixer is constructed of switched GaAs FETs and novel planar transformer baluns on the chip. The device can be used as an up or downconverter for 1.1 to 1.7 GHz applications. The consistent MMIC performance will improve system operation. The package dimensions are 0.118" x 0.192" (3.0 x 4.9 mm).

### Electrical Specifications, $T_A = +25^\circ \text{C}$ , As a Function of LO Drive, $V_{GG} = -1.5 \text{Vdc}$

Parameter	LO = +11 dBm			LO = +7 dBm			LO = +3 dBm			Units
	Min.	Typ.	Max.	Min.	Typ.	Max.	Min.	Typ.	Max.	
Frequency Range, RF & LO	1.1 - 1.7			1.1 - 1.7			1.2 - 1.6			GHz
Frequency Range, IF	DC - 0.7			DC - 0.5			DC - 0.4			GHz
Conversion Loss		7	10		7.5	10.5		7.5	11.5	dB
Noise Figure (SSB)		7	10		7.5	10.5		7.5	11.5	dB
LO to RF Isolation	30	40		35	40		35	40		dB
LO to IF Isolation	21	26		22	26		22	26		dB
IP3 (Input)	20	24		15	18		11	14		dBm
1 dB Gain Compression (Input)	10	14		6	9		2	4		dBm

\*Unless otherwise noted, all measurements performed as downconverter,  $I_F = 70 \text{ MHz}$ .

**LOW LO DRIVE DOUBLE-BALANCED  
FET MIXER, 1.1 - 1.7 GHz**



**Conversion Loss vs.  
Temperature @ LO = 11 dBm**

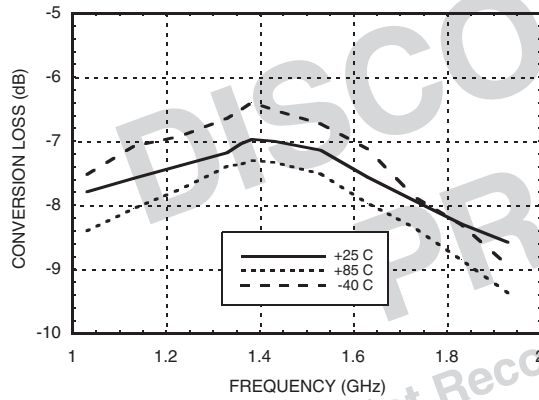

**Isolation @ LO = 11 dBm**

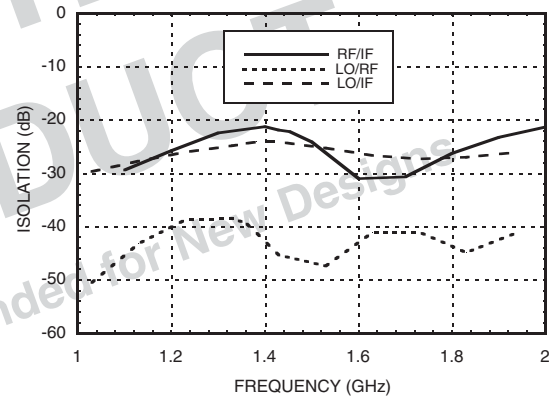

**Conversion Loss vs. LO Drive**

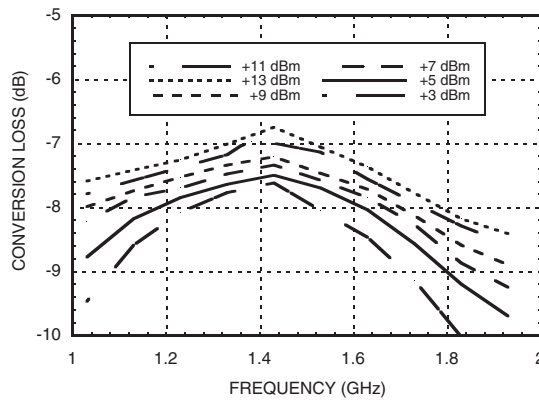

**Return Loss @ LO = 11 dBm**

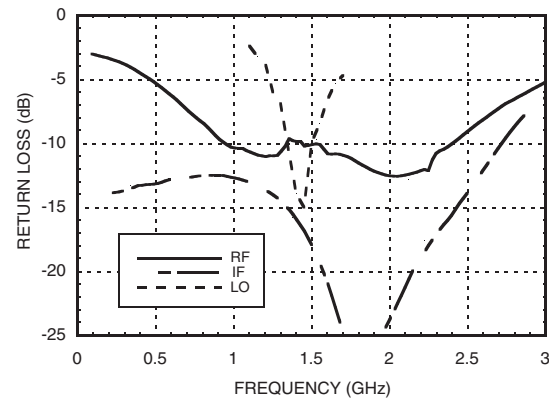

**If Bandwidth @ LO = 11 dBm**

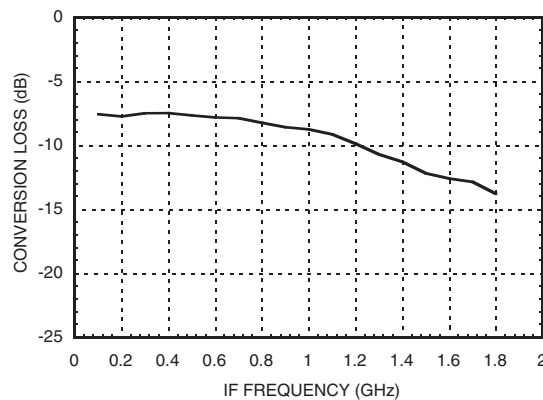

10

MIXERS - SINGLE & DOUBLE BALANCED - SMT

## LOW LO DRIVE DOUBLE-BALANCED FET MIXER, 1.1 - 1.7 GHz

**P1dB vs. LO Level, V<sub>gg</sub> = -1.5 V**

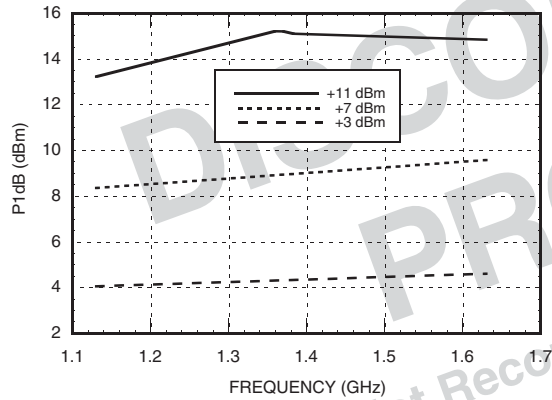

**Input IP3 vs. LO Drive \***

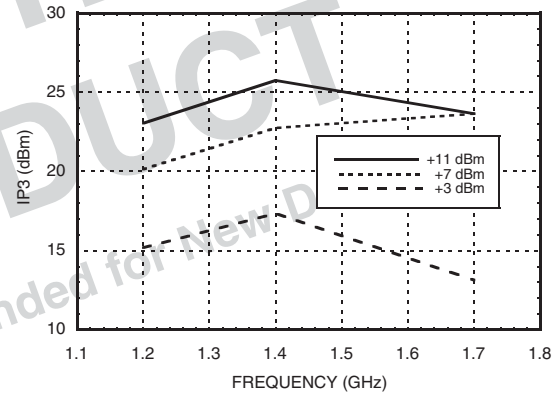

**Input IP3 vs. Temperature @ LO = 11 dBm\***

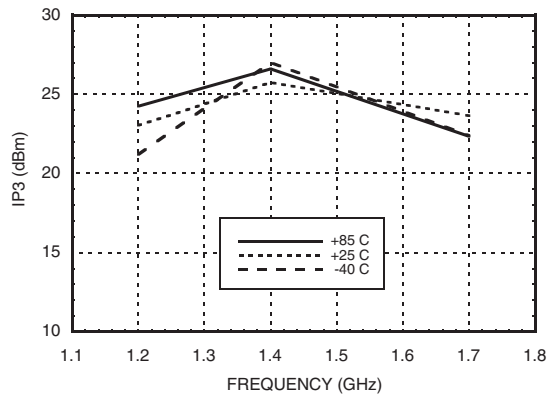

**Input IP2 vs. Temperature @ LO = +11 dBm\***

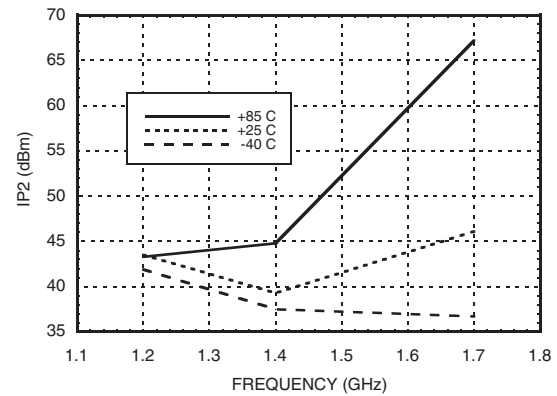

\* Two-tone input power = 0 dBm each tone, 1 MHz spacing.

**MxN Spurious Outputs**

mRF	nLO				
	0	1	2	3	4
0	xx	-35	0	29	18
1	17	0	33	14	34
2	48	67	47	55	51
3	79	76	70	89	72
4	>105	>106	>102	99	92

RF = 1.47 GHz @ -10 dBm  
 LO = 1.4 GHz @ 11 dBm, Vgg= -1.5V  
 All values in dBc relative to the IF

**Harmonics of LO**

LO Frequency (GHz)	nLO Spur at RF Port			
	1	2	3	4
1	41	27	47	45
1.2	27	25	41	47
1.4	30	22	42	44
1.6	29	23	54	52
1.8	36	29	57	57
2	27	29	60	59

LO = 11 dBm, Vgg= -1.5V  
 Values in dBc below input LO level measured at the RF port.

**Absolute Maximum Ratings**

RF / IF Input	+20 dBm
LO Drive	+27 dBm
Storage Temperature	-65 to +150 °C
Operating Temperature	-40 to +85 °C
Vgg	-10V
ESD Sensitivity (HBM)	Class 1A

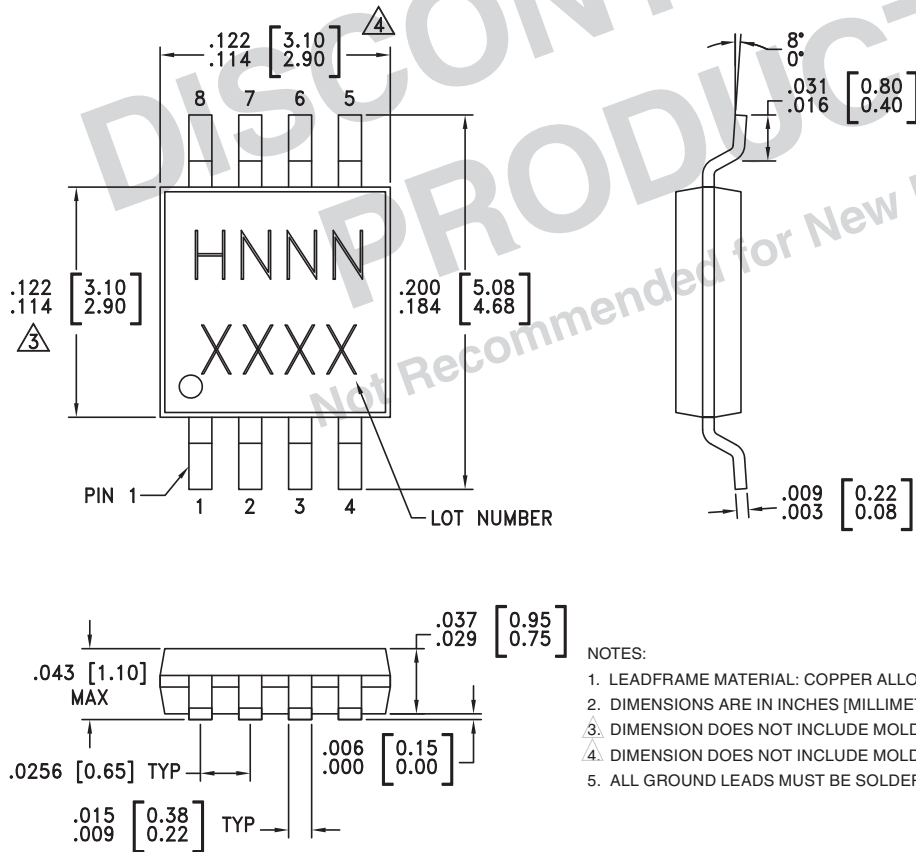

**ELECTROSTATIC SENSITIVE DEVICE  
OBSERVE HANDLING PRECAUTIONS**

**Outline Drawing**

**NOTES:**

1. LEADFRAME MATERIAL: COPPER ALLOY
2. DIMENSIONS ARE IN INCHES [MILLIMETERS]
3. DIMENSION DOES NOT INCLUDE MOLDFLASH OF 0.15mm PER SIDE.
4. DIMENSION DOES NOT INCLUDE MOLDFLASH OF 0.25mm PER SIDE.
5. ALL GROUND LEADS MUST BE SOLDERED TO PCB RF GROUND.

**Package Information**

Part Number	Package Body Material	Lead Finish	MSL Rating	Package Marking <sup>[3]</sup>
HMC296MS8	Low Stress Injection Molded Plastic	Sn/Pb Solder	MSL1 <sup>[1]</sup>	H296 XXXX
HMC296MS8E	RoHS-compliant Low Stress Injection Molded Plastic	100% matte Sn	MSL1 <sup>[2]</sup>	H296 XXXX

[1] Max peak reflow temperature of 235 °C

[2] Max peak reflow temperature of 260 °C

[3] 4-Digit lot number XXXX

### Evaluation PCB

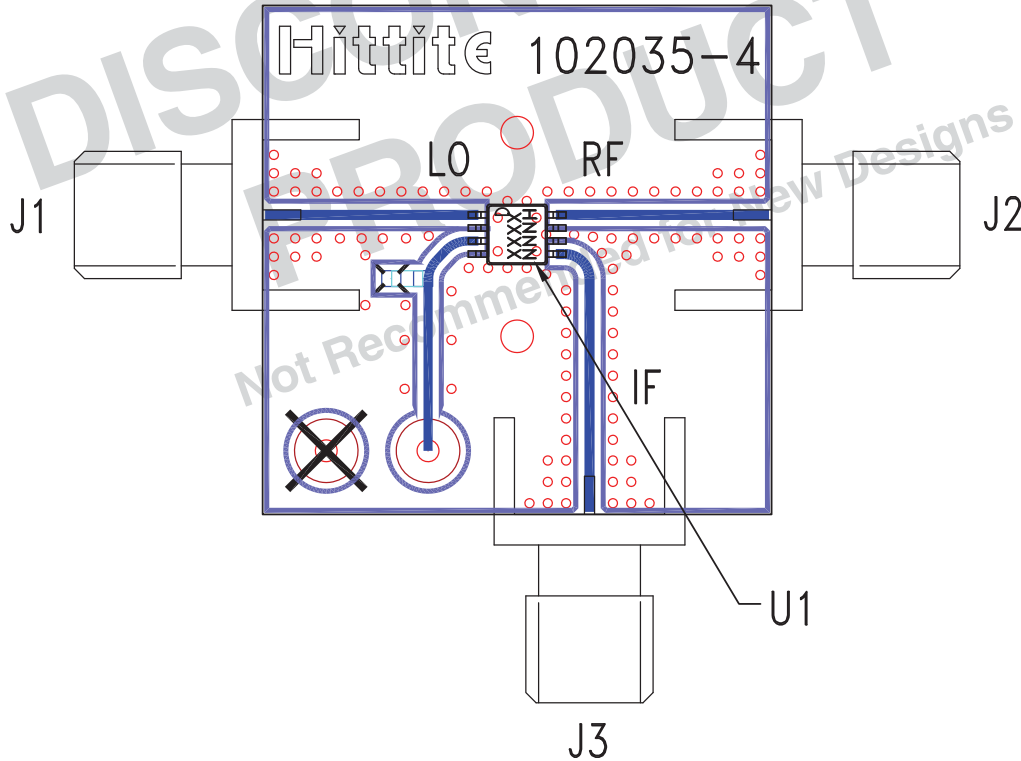

### List of Materials for Evaluation PCB 102037 [1]

Item	Description
J1 - J3	PCB Mount SMA F Connector
U1	HMC296MS8 / HMC296MS8E Mixer
PCB [2]	102035 Eval Board

[1] Reference this number when ordering complete evaluation PCB

[2] Circuit Board Material: FRA

The circuit board used in the application should use RF circuit design techniques. Signal lines should have 50 Ohm impedance while the package ground leads and exposed paddle should be connected directly to the ground plane similar to that shown. A sufficient number of via holes should be used to connect the top and bottom ground planes. The evaluation circuit board shown is available from Hittite upon request.