





THT POWER INDUCTORS

Toroid - Vertical, Low Profile and *KlipMount*[™]



-  Available in vertical, low profile and *KlipMount*[™]
-  SMPS averaging filter
-  Characterized for general purpose use and ripple filters
-  Single-layer designs
-  Can be used as differential mode inductors in EMI filters³

Electrical Specifications @ 25°C — Operating Temperature -40°C to 130°C

REFERENCE OPERATING VALUES						DESIGN CONTROL VALUES					
Vertical ⁶ Part Number	Low Profile Part Number	Inductance ¹ Typical (μ H)	I _{DC} (AMPS)	ET _{TOP} (V- μ Sec)	Energy ⁴ Storage (μ J)	Inductance No DC (μ H) $\pm 20\%$	20kHz Test mV No DC ²	DCR ⁵ (Ω MAX)	Coil Size Code	Klip* Mount Package	Lead Diameter (In) $\pm .003$
PE-51591	—	20	2.0	52	40	32.8	33	.060	H	—	.020
PE-92100	—	25	2.6	30	85	20.7	22	.043	A	KM1	.020
PE-92101	PE-92401	50	2.6	50	169	45.7	45	.071	B	KM2	.020
PE-92102	PE-92402	100	2.6	90	338	94.1	90	.100	C	KM3	.020
PE-92103	—	35	2.6	55	118	28.4	36	.037	B	KM2	.025
PE-92104	PE-92404	70	3.0	85	315	61.0	73	.052	C	KM3	.025
PE-92105	PE-92405	145	3.0	140	653	141.8	140	.087	D	KM4	.025
PE-92106	—	285	3.0	300	1283	264.1	340	.140	E	KM5	.025
PE-92107	—	450	3.0	425	2025	436.3	500	.200	F	—	.025
PE-92108	PE-92408	67	3.6	130	648	90.7	110	.045	D	KM4	.032
PE-92109	—	165	4.0	240	1320	152.0	260	.070	E	KM5	.032
PE-92110	—	270	4.0	350	2160	263.9	400	.100	F	—	.032
PE-92111	—	40	4.0	70	320	37.9	57	.027	C	KM3	.032
PE-51590	—	22	5.0	44	275	20.3	37	.020	G	—	.032
PE-92112	PE-92412	100	5.0	200	1250	90.7	180	.034	E	KM5	.042
PE-92113	—	170	5.0	300	2125	159.7	310	.050	F	—	.042
PE-92114	PE-92414	35.6	5.0	100	688	55.6	88	.023	D	KM4	.042
PE-92115	—	95	7.0	225	2328	96.0	200	.025	F	—	.051
PE-92116	PE-92416	55	7.0	150	1348	49.1	100	.017	E	KM5	.051
PE-92117	—	55	10.0	175	2750	55.9	120	.013	F	—	.064

*Parts available with *KlipMount* option can be ordered by adding a "K" suffix to the part number (i.e. PE-92100K).

Relationships Between Reference and Operating Conditions

Inductance vs. DC Current
(at reference ET)



Inductance vs. Operating ET
(at reference I_{DC})



Max. Operating ET vs. Frequency
(at reference I_{DC})

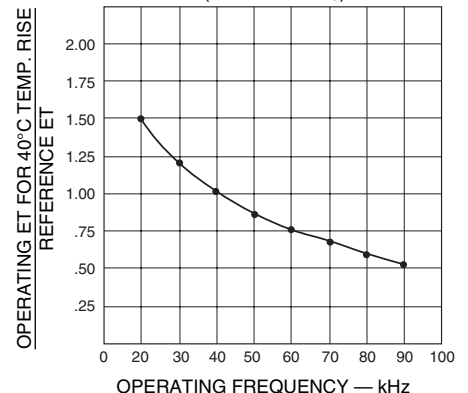

THT POWER INDUCTORS

Toroid - Vertical, Low Profile and *KlipMount™*



Mechanicals

- Base material meets flammability requirements of UL 94V-0
- Mechanically rigid mount
- PC board — automatic insertability
- Lowest cost

KlipMount™ Package

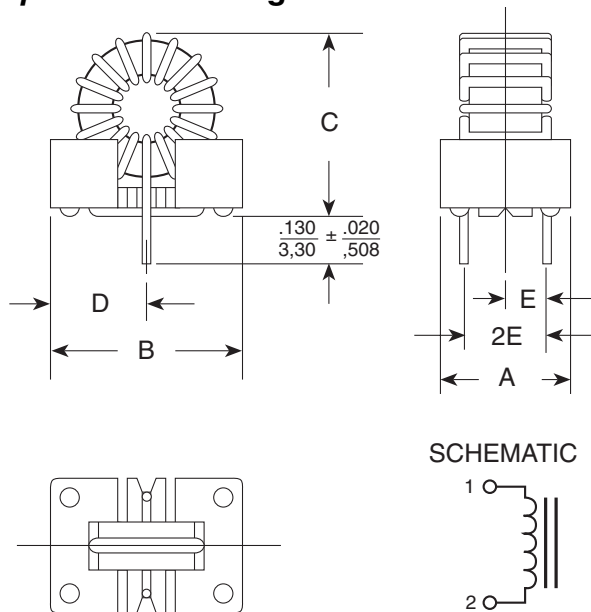

Standard Package	A	B	C	D	E
	Maximum			Typical	
KM-1	.340 8,64	.580 14,73	.650 16,51	.29 7,37	.110 2,79
KM-2	.450 11,43	.650 16,51	.700 17,78	.325 8,26	.150 3,81
KM-3	.450 11,43	.850 21,59	.950 24,13	.415 10,54	.150 3,81
KM-4	.620 15,50	.970 24,64	1.10 27,94	.475 12,07	.225 5,72
KM-5	.700 17,78	1.30 33,02	1.40 35,56	.625 15,88	.250 6,35

Note: Units with large wire sizes may exceed B dimension.
KLIPMOUNT™ is a trademark of Pulse Engineering, Inc.

Dimensions: $\frac{\text{Inches}}{\text{mm}}$ Unless otherwise specified, all tolerances are $\pm \frac{.010}{0,25}$

Coil Size	P (MAX)	N (MAX)	L (+.125/-.025)	M	K
A	.550 13,97	.250 6,35	.375 9,53	.180 4,57	—
B	.700 17,78	.380 9,65	.375 9,53	.280 7,11	.530 ± .050 13,46 ± 1,27
C	.850 21,59	.410 10,41	.375 9,53	.280 7,11	.720 ± .050 18,29 ± 1,27
D	1.050 26,67	.550 13,97	.375 9,53	.400 10,16	.840 ± .020 21,24 ± 0,51
E	1.400 35,56	.700 17,78	.375 9,53	.500 12,7	1.100 ± .100 27,94 ± 2,54
F	1.650 41,91	.700 17,78	.375 9,53	.500 12,7	—
G	.850 21,59	.330 8,38	.875 22,23	.330 8,38	—
H	.640 16,26	.280 7,11	.875 22,23	.280 7,11	—

Vertical Package

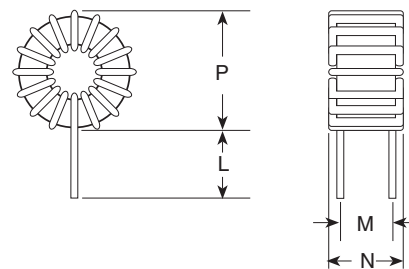

Low Profile Package

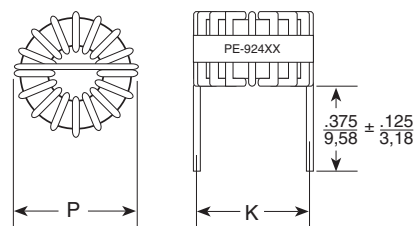

NOTES:

1. Typical Inductance occurs at I_{DC} and E_{TOP} values shown.
2. Design control test voltage is critical. Inductance increases with voltage.
3. For line filter applications, RMS line current is limited to specified reference DC Current.
4. $\frac{LI^2}{2}$ rating is the ability of the inductor to store energy.
5. DCR for vertical part measured close to coil. Add 10% more for low profile part.
6. RoHS compliant parts are available. Order RoHS compliant parts by adding the suffix "NL" to the part number (i.e. PE-51591 becomes PE-51591NL).

For More Information:

Pulse Worldwide Headquarters
 12220 World Trade Drive
 San Diego, CA 92128
 U.S.A.
www.pulseeng.com
 TEL: 858 674 8100
 FAX: 858 674 8262

Pulse Northern Europe
 3 Huxley Road
 Surrey Research Park
 Guildford, Surrey GU2 5RE
 United Kingdom
 TEL: 44 1483 401700
 FAX: 44 1483 401701

Pulse Southern Europe
 Zone Industrielle
 F-39270
 Orgelet
 France
 TEL: 33 3 84 35 04 04
 FAX: 33 3 84 25 46 41

Pulse China Headquarters
 No. 1
 Industrial District
 Changan, Dongguan
 China
 TEL: 86 769 85538070
 FAX: 86 769 85538870

Pulse North China
 Room 1503
 XinYin Building
 No. 888 YiShan Road
 Shanghai 200233
 China
 TEL: 86 21 54643211/2
 FAX: 86 21 54643210

Pulse South Asia
 150 Kampong Ampat
 #07-01/02
 KA Centre
 Singapore 368324
 TEL: 65 6287 8998
 FAX: 65 6280 0080

Pulse North Asia
 No. 26
 Kao Ching Road
 Yang Mei Chen
 Taoyuan Hsien
 Taiwan, R. O. C.
 TEL: 886 3 4641811
 FAX: 886 3 4641911

Performance warranty of products offered on this data sheet is limited to the parameters specified. Data is subject to change without notice. Other brand and product names mentioned herein may be trademarks or registered trademarks of their respective owners.
 © Copyright, 2006. Pulse Engineering, Inc. All rights reserved.