

Dual IGBTMOD™ HVIGBT Module 150 Amperes/4500 Volts

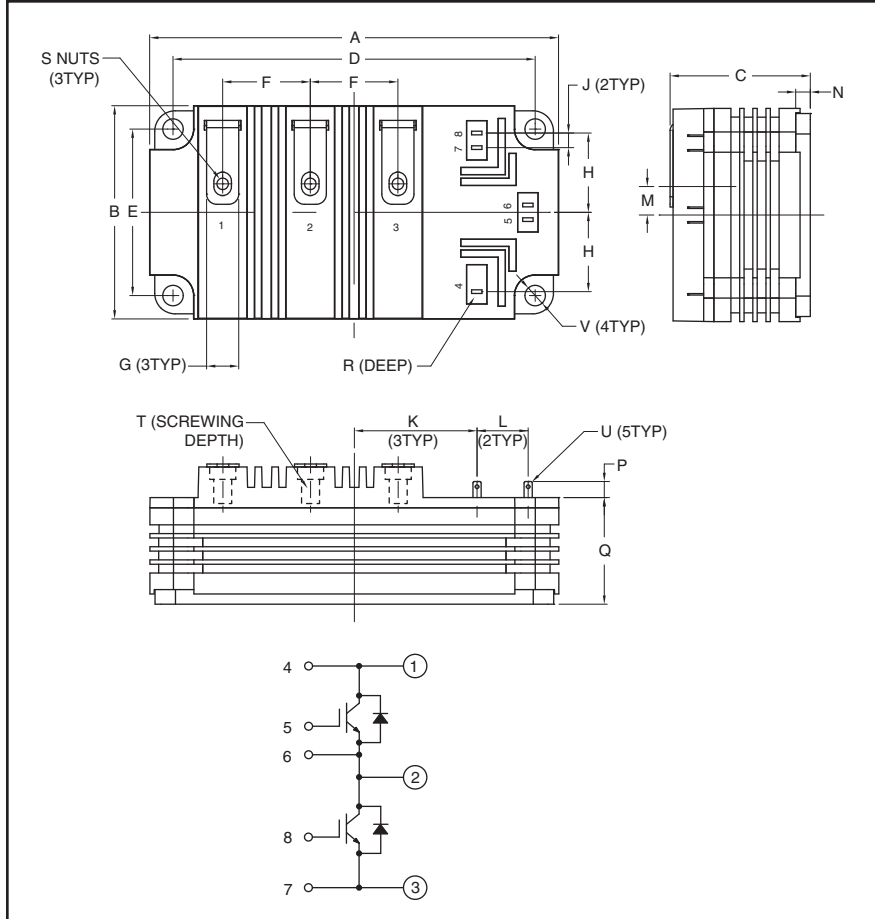

Description:

Powerex IGBTMOD™ Modules are designed for use in switching applications. Each module consists of two IGBT Transistors in a half-bridge configuration with each transistor having a reverse-connected super-fast recovery free-wheel diode. All components and interconnects are isolated from the heat sinking baseplate, offering simplified system assembly and thermal management.

Features:

- Low $V_{CE(sat)}$
- Creepage and Clearance meet IEC 60077-1
- High Isolation Voltage
- Rugged SWSOA and RRSOA
- Compact Industry Standard Package

Applications:

- Traction
- Medium Voltage Drives
- High Voltage Power Supplies

Outline Drawing and Circuit Diagram

Dimensions	Inches	Millimeters
A	5.51	140.0
B	2.87	73.0
C	1.89	48.0
D	4.88±0.01	124.0±0.25
E	2.24±0.01	57.0±0.25
F	1.18	30.0
G	0.43	11.0
H	1.07	27.15
J	0.20	5.0
K	1.65	42.0

Dimensions	Inches	Millimeters
L	0.69±0.01	17.5±0.25
M	0.38	9.75
N	0.20	5.0
P	0.22	5.5
Q	1.44	36.5
R	0.16	4.0
S	M6 Metric	M6
T	0.63 Min.	16.0 Min.
U	0.11 x 0.02	2.8 x 0.5
V	0.28 Dia.	7.0 Dia.



Powerex, Inc., 173 Pavilion Lane, Youngwood, Pennsylvania 15697 (724) 925-7272 www.pwr.com

QID4515002
Dual IGBTMOD™ HVIGBT Module
 150 Amperes/4500 Volts

Absolute Maximum Ratings, $T_j = 25\text{ °C}$ unless otherwise specified

Ratings	Symbol	QID4515002	Units
Junction Temperature	T_j	-40 to 150	°C
Storage Temperature	T_{stg}	-40 to 125	°C
Collector-Emitter Voltage ($V_{GE} = 0V, T_j = -40$ to $+125\text{ °C}$)	V_{CES}	4500	Volts
Collector-Emitter Voltage ($V_{GE} = 0V, T_j = -50\text{ °C}$)	V_{CES}	4400	Volts
Gate-Emitter Voltage ($V_{CE} = 0V$)	V_{GES}	± 20	Volts
Collector Current, DC ($T_C = 82\text{ °C}$)	I_C	150	Amperes
Peak Collector Current (Pulse)	I_{CM}	300*	Amperes
Diode Forward Current**	I_F	150	Amperes
Diode Forward Surge Current** (Pulse)	I_{FM}	300*	Amperes
I^2t for Diode ($t = 10\text{ms}$)	I^2t	10	kA^2sec
Maximum Collector Dissipation ($T_C = 25\text{ °C}$, IGBT Part, $T_{j(max)} \leq 150\text{ °C}$)	P_C	1500	Watts
Mounting Torque, M6 Terminal Screws	—	44	in-lb
Mounting Torque, M6 Mounting Screws	—	44	in-lb
Module Weight (Typical)	—	900	Grams
Isolation Voltage (Charged Part to Baseplate, AC 60Hz 1 min.)	V_{iso}	9.0	kVolts
Partial Discharge	Q_{pd}	10	pC
(V1 = 4800 V _{RMS} , V2 = 3500 V _{RMS} , f = 60Hz (Acc. to IEC 1287))			
Maximum Short-Circuit Pulse Width,	t_{psc}	10	μs
(V _{CC} ≤ 3200V, V _{GE} = ±15V, R _{G(off)} ≥ 60Ω, T _j = 125°C)			

Electrical Characteristics, $T_j = 25\text{ °C}$ unless otherwise specified

Characteristics	Symbol	Test Conditions	Min.	Typ.	Max.	Units
Collector-Cutoff Current	I_{CES}	$V_{CE} = V_{CES}, V_{GE} = 0V$	—	—	1.8	mA
Gate Leakage Current	I_{GES}	$V_{GE} = V_{GES}, V_{CE} = 0V$	—	—	0.5	μA
Gate-Emitter Threshold Voltage	$V_{GE(th)}$	$I_C = 13.3\text{mA}, V_{CE} = 10V$	5.8	6.3	6.8	Volts
Collector-Emitter Saturation Voltage	$V_{CE(sat)}$	$I_C = 150\text{A}, V_{GE} = 15V, T_j = 25\text{ °C}$	—	3.8	—	Volts
		$I_C = 150\text{A}, V_{GE} = 15V, T_j = 125\text{ °C}$	—	4.6	5.5	Volts
Total Gate Charge	Q_G	$V_{CC} = 2800V, I_C = 150\text{A}, V_{GE} = 15V$	—	1.5	—	μC
Emitter-Collector Voltage**	V_{EC}	$I_E = 150\text{A}, V_{GE} = 0V, T_j = 25\text{ °C}$	—	2.8	—	Volts
		$I_E = 150\text{A}, V_{GE} = 0V, T_j = 125\text{ °C}$	—	3.2	3.8	Volts

* Pulse width and repetition rate should be such that device junction temperature (T_j) does not exceed $T_{j(max)}$ rating.
 **Represents characteristics of the anti-parallel, emitter-to-collector free-wheel diode (FWDi).

QID4515002

Dual IGBTMOD™ HVIGBT Module

150 Amperes/4500 Volts

Electrical Characteristics, $T_j = 25\text{ }^\circ\text{C}$ unless otherwise specified

Characteristics	Symbol	Test Conditions	Min.	Typ.	Max.	Units	
Input Capacitance	C_{ies}		—	19	—	nF	
Output Capacitance	C_{oes}	$V_{GE} = 0V, V_{CE} = 10V, f = 100kHz$	—	1.22	—	nF	
Reverse Transfer Capacitance	C_{res}		—	0.55	—	nF	
Resistive	Turn-on Delay Time	$t_{d(on)}$	$V_{CC} = 2800V, I_C = 133A,$	—	1.00	—	μs
Load	Rise Time	t_r	$V_{GE} = \pm 15V, R_{G(on)} = 24.3\Omega,$	—	0.30	—	μs
Switching	Turn-off Delay Time	$t_{d(off)}$	$R_{G(off)} = 90\Omega, L_S = 150nH$	—	3.6	—	μs
Times	Fall Time	t_f	Inductive Load	—	0.36	—	μs
Turn-on Switching Energy	E_{on}	$T_j = 125^\circ C, I_C = 133A, V_{GE} = \pm 15V,$	—	0.55	—	J/P	
Turn-off Switching Energy	E_{off}	$R_{G(on)} = 24.3\Omega, R_{G(off)} = 90\Omega,$ $V_{CC} = 2800V, L_S = 150nH, \text{ Inductive Load}$	—	0.34	—	J/P	
Diode Reverse Recovery Time**	t_{rr}	$V_{CC} = 2800V, I_E = 133A,$	—	0.7	—	μs	
Diode Reverse Recovery Charge**	Q_{rr}	$V_{GE} = \pm 15V, R_{G(on)} = 24.3\Omega,$	—	111*	—	μC	
Diode Reverse Recovery Energy	E_{rec}	$L_S = 150nH, \text{ Inductive Load}$	—	172	—	mJ/P	
Stray Inductance (C1-E2)	L_{SCE}		—	60	—	nH	
Lead Resistance Terminal-Chip	R_{CE}		—	0.8	—	m Ω	

Thermal and Mechanical Characteristics, $T_j = 25\text{ }^\circ\text{C}$ unless otherwise specified

Characteristics	Symbol	Test Conditions	Min.	Typ.	Max.	Units
Thermal Resistance, Junction to Case***	$R_{th(j-c)}$ Q	Per IGBT	—	—	0.083	$^\circ K/W$
Thermal Resistance, Junction to Case***	$R_{th(j-c)}$ D	Per FWDi	—	—	0.157	$^\circ K/W$
Contact Thermal Resistance, Case to Fin	$R_{th(c-f)}$	Per Module, Thermal Grease Applied, $\lambda_{grease} = 1W/mK$	—	0.018	—	$^\circ K/W$
Comparative Tracking Index	CTI		600	—	—	
Clearance Distance in Air (Terminal to Base)	$d_{a(t-b)}$		35.0	—	—	mm
Creepage Distance Along Surface (Terminal to Base)	$d_{s(t-b)}$		64	—	—	mm
Clearance Distance in Air (Terminal to Terminal)	$d_{a(t-t)}$		19	—	—	mm
Creepage Distance Along Surface (Terminal to Terminal)	$d_{s(t-t)}$		54	—	—	mm

*Pulse width and repetition rate should be such that device junction temperature rise is negligible.

**Represents characteristics of the anti-parallel, emitter-to-collector free-wheel diode (FWDi).

*** T_C measurement point is just under the chips.

QID4515002

Dual IGBTMOD™ HVIGBT Module

150 Amperes/4500 Volts

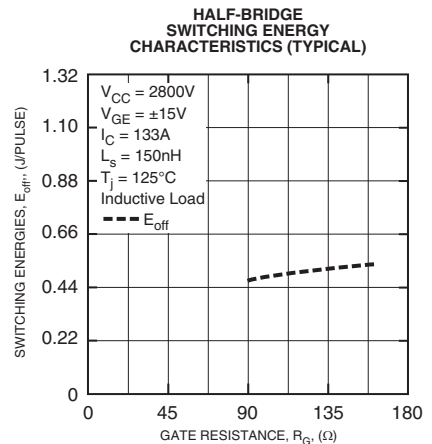
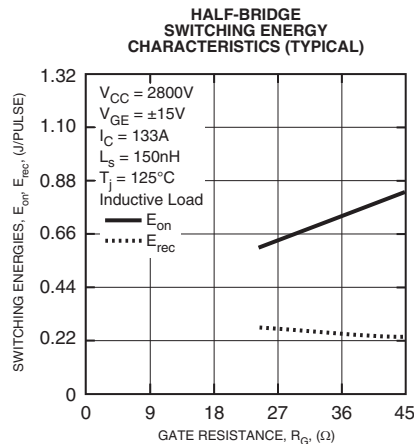
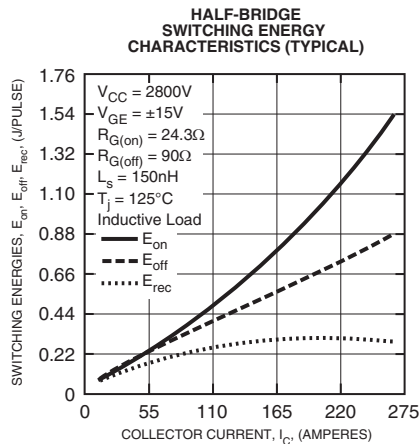
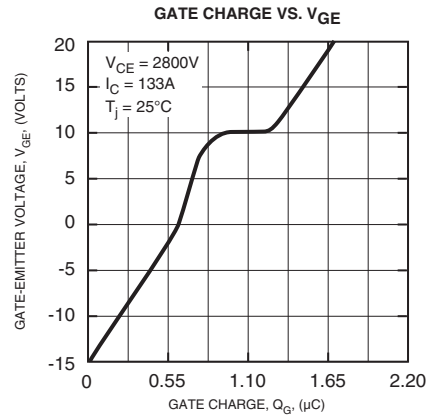
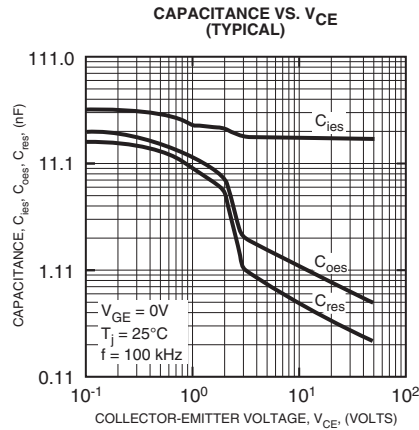
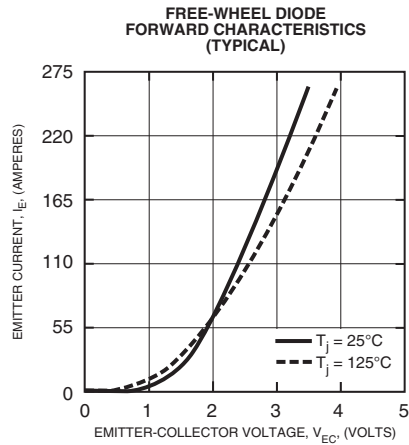
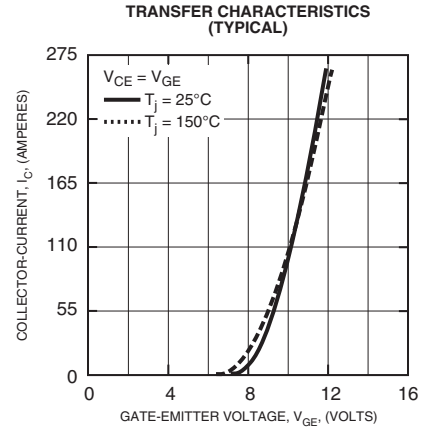
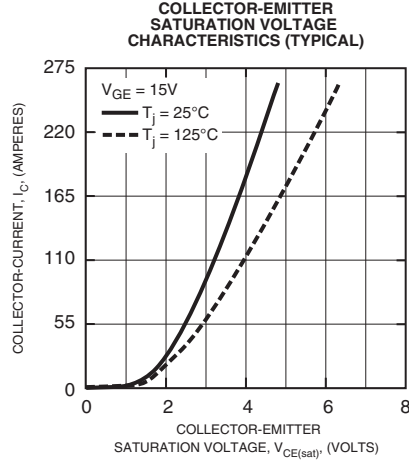
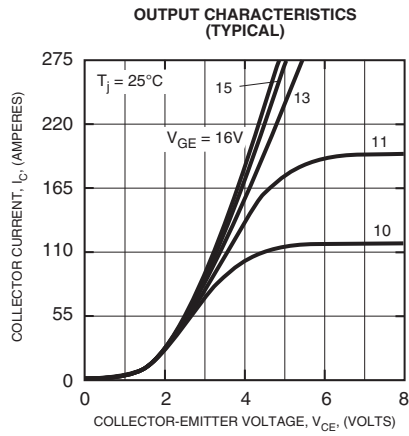

QID4515002

Dual IGBTMOD™ HVIGBT Module

150 Amperes/4500 Volts

