

SP series

Washable snap-action pushbutton switches

Distinctive features and specifications

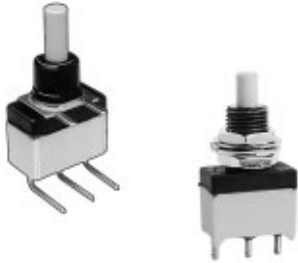

☐ Sealed

- Secure assembly of the two case parts
- Internally sealed bushing
- Epoxy sealed terminals

☐ Process compatible (plain bushing models)

- Wave solderable
- Washable

ELECTRICAL SPECIFICATIONS

- Max. current/voltage rating with resistive load :
 - gold plated brass contacts : 100mA 30VDC
 - silver or gold plated silver contacts : 1A 120VAC - 1A 30VDC
- Initial contact resistance : 50 mΩ max.
- Insulation resistance : 1.000 MΩ min.
- Dielectric strength : 1.000 Vrms 50 Hz min.
- Electrical life : 60.000 cycles

MATERIALS

- Case and cover : UL94-V0, polyamide, glass filled or PES
- Actuator : polyamide, glass filled
- Contacts
 - 0 : brass, gold plated
 - 1 : silver
 - 2 : silver, gold plated
- Terminal seal : epoxy

GENERAL SPECIFICATIONS

- Torque : 0,25 Nm (.18 Ft.lb) applied to nut (threaded bushing)
- Total travel : 0,50 mm (.019)
- Mechanical strength :
Terminals are strengthened by a bracket or a ground plate ensuring the rigidity of the switch on the board. Actuator strength is 10N max.
- Operating temperature : -20°C to +85°C
- Storage temperature : -40°C to +85°C
- Moisture :
The insulating materials employed and the complete seal permit the switches to withstand a 56 days moisture test (IEC 68-2-3).
- Soldering - thermal shock (plain bushing models only) :
The switches are especially designed for flow soldering at 260°C during 5 seconds owing to high temperature polymer parts.
- Iron soldering (threaded bushing models) : 300°C max., 5 seconds max.
- Solderability : The switches are tested at 235°C according to IEC 68-2-20 after accelerated aging.

AGENCY APPROVAL



Availability : all models with silver or gold plated silver contacts.

Marking : to order switches marked UL, complete appropriate box of ordering format.

SP series

Washable snap-action pushbutton switches

Overview

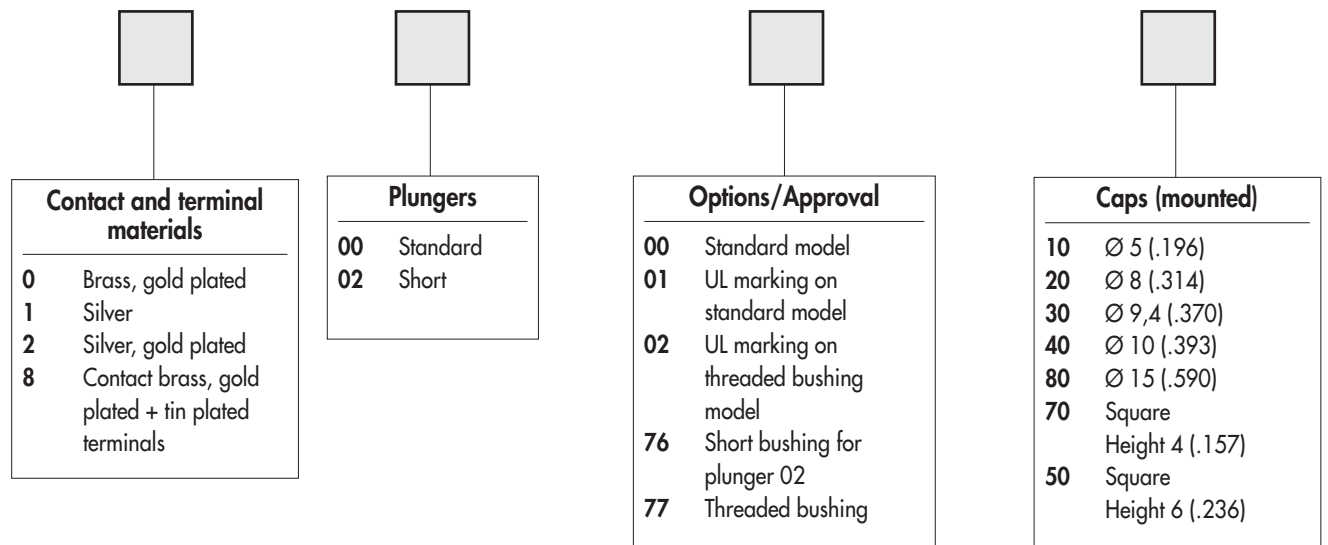
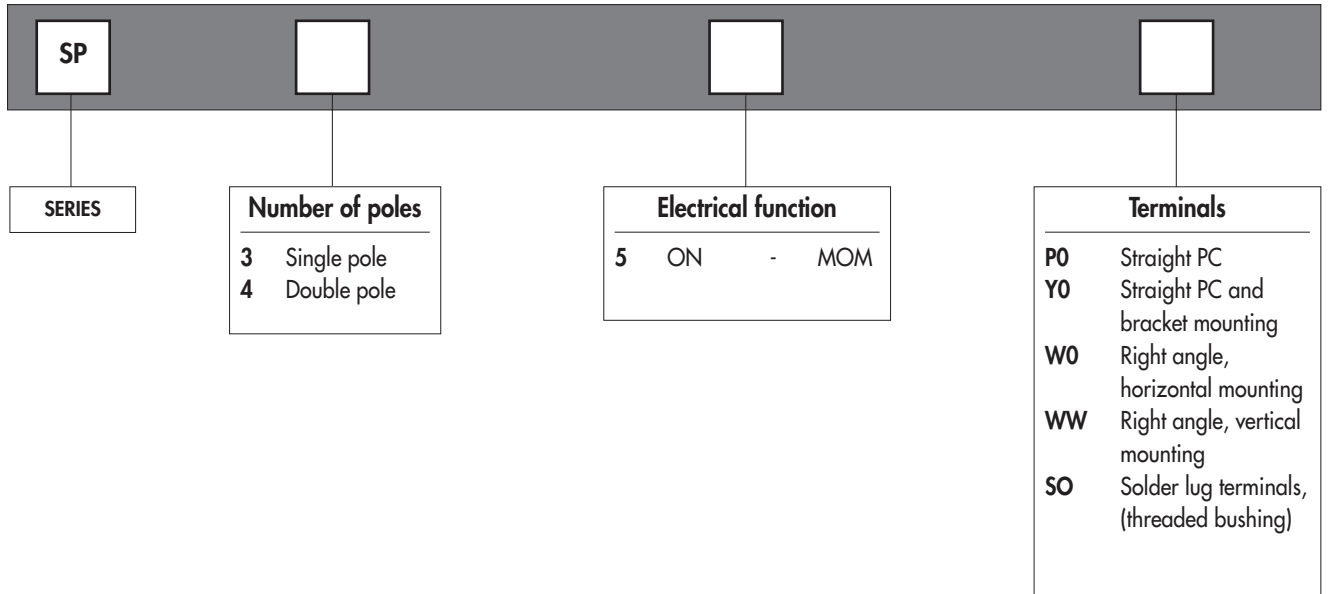

ABOUT THIS SERIES

On the following pages, you will find successively :

- model structure of switches
- options in the same order as above

Specifications are on previous page.

Dimensions : first dimensions are in mm while inches are shown as bracketted numbers.



Mounting accessories : standard hardware supplied with all models with Ø 6,35 (1/4) threaded bushing :

2 hex nuts 8 mm (.314) across flats, 1 locking ring and 1 lockwasher.
Standard and special hardware available are presented in section I.



Packaging unit : 25 or 50 pieces depending on model.

SP series

Washable snap-action pushbutton switches

Plain or threaded bushing

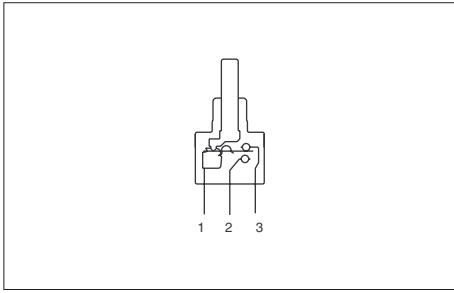

- Solder lug, straight PC or right angle terminals
- Features of threaded bushing models :
 - max. torque : 0,25 Nm (.18 Ft.lb)
 - iron soldering : 300°C max., 5 seconds max.
- 1 and 2 pole configurations

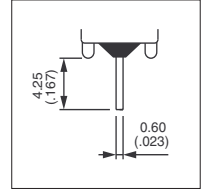
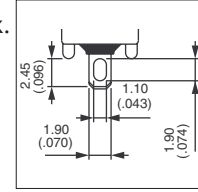

MODEL STRUCTURE

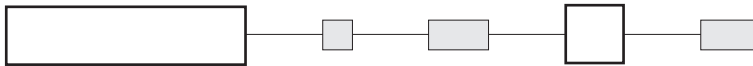

Shown with standard plunger

Plain bushing - straight PC terminals



Single pole

SP35P0... 00

Double pole

SP45P0... 00



1-3



1-2

ON - MOM

ON - MOM

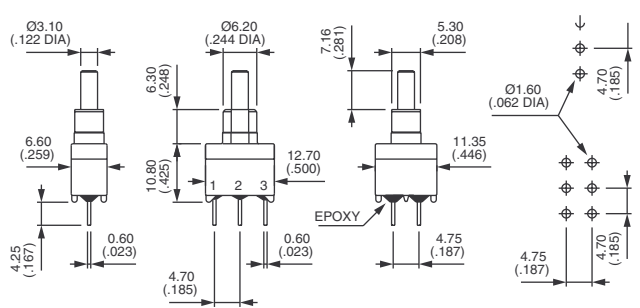

Plain bushing - bracket mounting



Single pole

SP35Y0... 00

Double pole

SP45Y0... 00



1-3



1-2

ON - MOM

ON - MOM

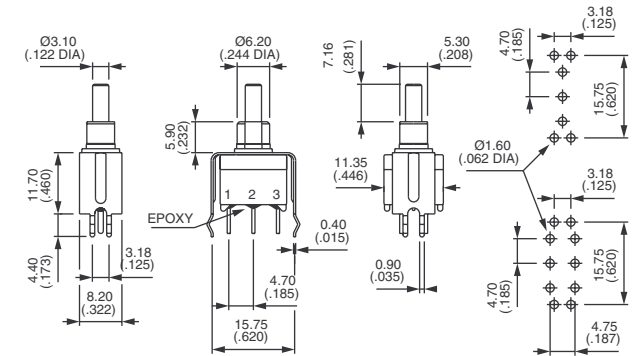

Plain bushing - right angle terminals - horizontal



Single pole

SP35W0... 00

Double pole

SP45W0... 00



1-3



1-2

ON - MOM

ON - MOM

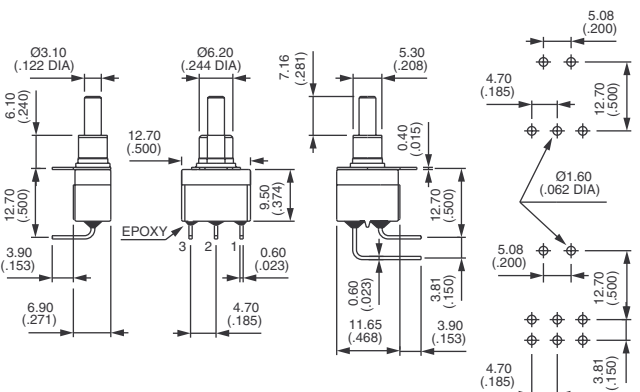



SP series

Washable snap-action pushbutton switches

Plain or threaded bushing

Shown with standard plunger

Plain bushing - right angle terminals - vertical



Single pole

SP35WW... 00

Double pole

SP45WW... 00



1-3



1-2

ON - MOM

ON - MOM

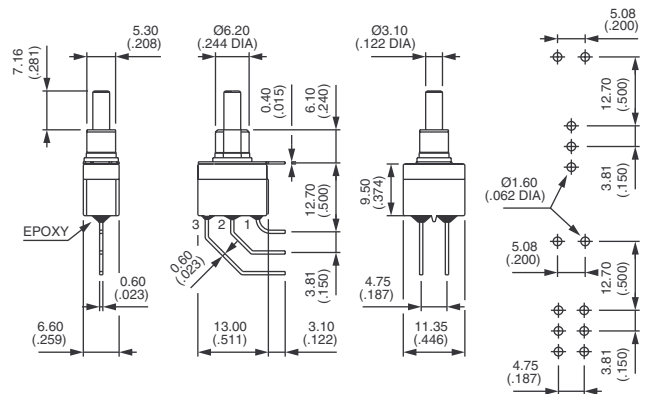

Threaded bushing - solder lug terminals

→ Keyway



Single pole

SP35S0... 77



1-3



1-2

ON - MOM

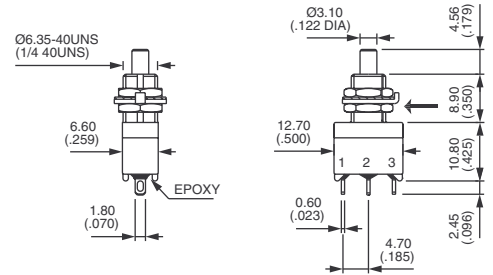

Threaded bushing - straight PC terminals

→ Keyway



Single pole

SP35P0... 77



1-3



1-2

ON - MOM

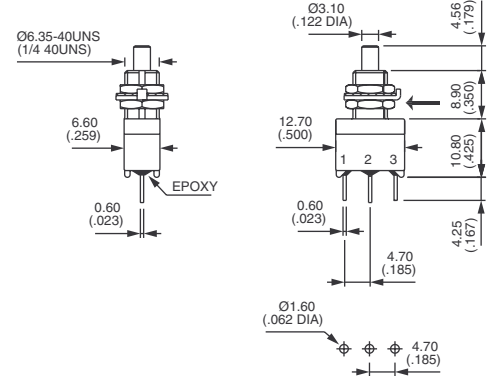

PANEL CUT-OUT

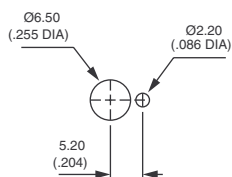

SP series

Washable snap-action pushbutton switches

OPTIONS



CONTACT AND TERMINAL MATERIALS

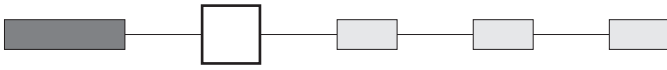

- 0 Brass, gold plated
- 1 Silver
- 2 Silver, gold plated
- 8 Contact brass, gold plated + tin plated terminals

PLUNGERS

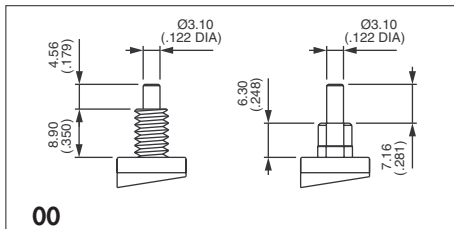

00 Standard plunger

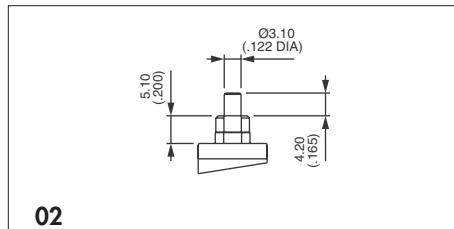

02 Short (for models with plain bushing, single pole only)
Order with option 76 below.

OPTIONS / AGENCY APPROVAL

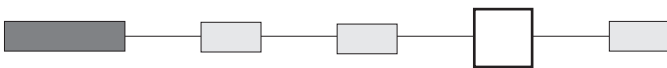

- 00 Standard model
- 01 UL marking for standard model
- 02 UL marking for threaded bushing model
- 76 Short plain bushing for 02 plunger (single pole models only)
- 77 Threaded bushing (included in model numbers on previous page)



SP series

Washable snap-action pushbutton switches

CAPS

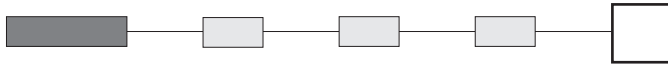

Blank Without cap

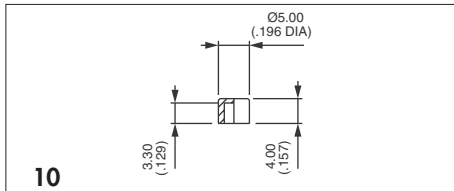

10
P/N U2400

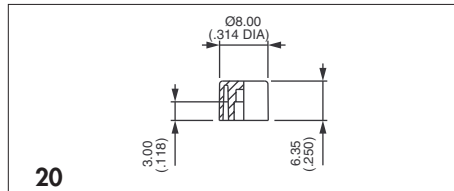

20
P/N U2510

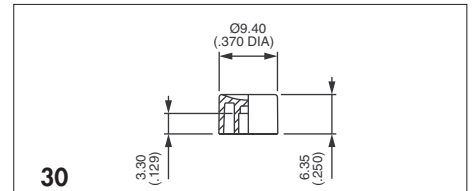

30
P/N U2130

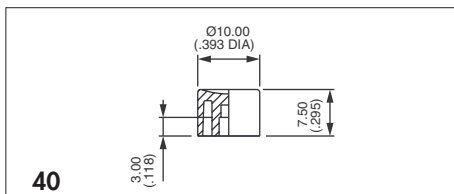

40
Standard - P/N U2900

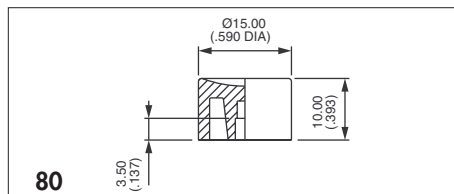

80
P/N U3400
Not available with plunger 02

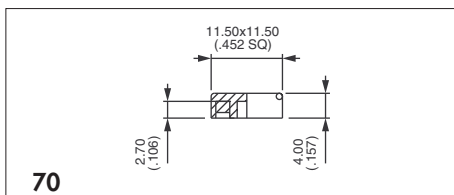

70
Square - P/N U910

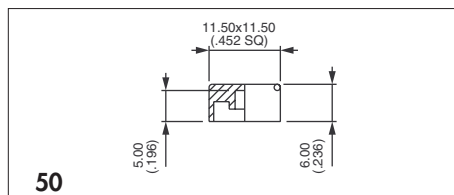

50
Square - P/N U2340
Not available with plunger 02

Cap colours	
Replace last "0" by number	
1	blue
1/4	dark blue
2	black
3	green
4	grey
5	yellow
6	red
7	ivory
7/1	white
9	orange

To order caps separately, use their P/N (U...) (for threaded bushing order only separately).

DRESS NUTS

Chrome plated

For threaded bushing models only.

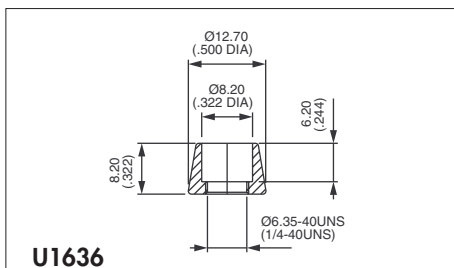

U1636
For cap U2510

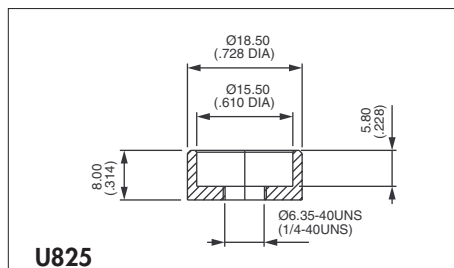

U825
For cap U3400

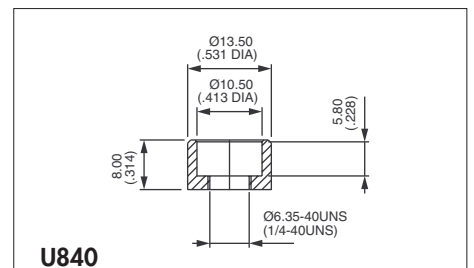

U840
For cap U2900

Dress nuts are to be ordered separately.