

OPERATIONAL AMPLIFIER & VOLTAGE REFERENCE

KL103/A

OPERATIONAL AMPLIFIER

- LOW INPUT OFFSET VOLTAGE : 0.5 mV typ.
- LOW SUPPLY CURRENT : 350 μ A/op.
(@ V_{cc} = 5V)
- MEDIUM BANDWIDTH (unity gain) : 0.9MHz
- LARGE OUTPUT VOLTAGE SWING : 0V to (V_{cc} – 1.5V)
- INPUT COMMON MODE VOLTAGE RANGE INCLUDES GROUND
- WIDE POWER SUPPLY RANGE : 3 to 32V \pm 1.5 to \pm 16V

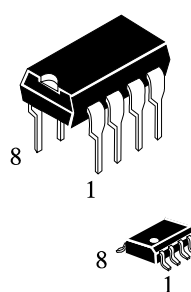

N SUFFIX
PLASTIC

D SUFFIX
SOIC

ORDERING INFORMATION
 KL103N/AN Plastic
 KL103D/AD SOIC
 T_A = -40° to 105° C for all packages.

VOLTAGE REFERENCE

- FIXED OUTPUT VOLTAGE REFERENCE 2.5V
- 0.4% AND 1% VOLTAGE PRECISION
- SINK CURRENT CAPABILITY : 1 to 100mA
- TYPICAL OUTPUT IMPEDANCE : 0.2 Ω

DESCRIPTION

The KL103/A is a monolithic IC that includes one independent op-amp and another op-amp for which the non inverting input is wired to a 2.5V fixed Voltage Reference. This device is offering space and cost saving in many applications like power supply management or data acquisition systems.

PIN CONNECTIONS (top view)

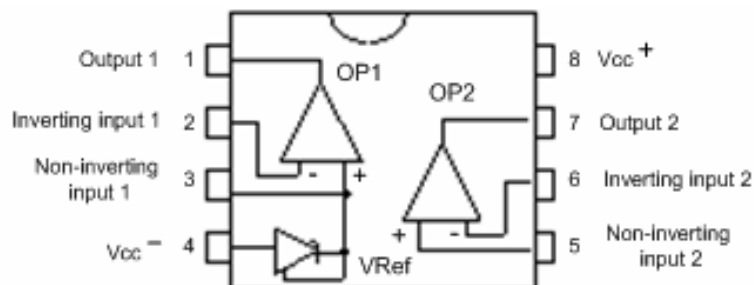

Absolute Maximum Ratings

Symbol	Parameter	Value	Unit
V _{cc}	Supply Voltage	36	V
V _{id}	Differential Input Voltage	36	V
V _i	Input Voltage	-0.3 to +36	V
T _j	Maximum Junction Temperature	150	°C

* Stresses beyond those listed under “absolute maximum ratings” may cause permanent damage to the device. These are stress ratings only and functional operation of the device at these or any other conditions beyond those indicated under “recommended operating conditions” is not implied. Exposure to absolute-maximum-rated conditions for extended periods may affect device reliability.

Electrical Characteristics

Symbol	Parameter	Min	Typ	Max	Unit
I _{cc}	Total Supply Current, excluding Current in the Voltage Reference V _{cc+} = 5 V, no load T _{min} < T _{amb} < T _{max} V _{cc+} = 30 V, no load T _{min} < T _{amb} < T _{max}		0.7	1.2 2	mA

OPERATOR 2 (independent op-amp)

 $V_{cc}^+ = +5\text{ V}$, $V_{cc} = \text{Ground}$, $V_o = 1.4\text{ V}$, $T_{amb} = 25\text{ }^\circ\text{C}$ (unless otherwise specified)

Symbol	Parameter	Min	Typ	Max	Unit
V_{io}	Input Offset Voltage KL103 $T_{amb} = 25\text{ }^\circ\text{C}$ $T_{min} \leq T_{amb} \leq T_{max}$ KL103A $T_{amb} = 25\text{ }^\circ\text{C}$ $T_{min} \leq T_{amb} \leq T_{max}$		1 0.5	4 5 2 3	mV
DV_{io}	Input Offset Voltage Drift			7	$\mu\text{V}/^\circ\text{C}$
I_{io}	Input Offset Current $T_{min.} \leq T_{amb} \leq T_{max}$		2	30 50	nA
I_{ib}	Input Bias Current $T_{min.} \leq T_{amb} \leq T_{max}$		20	150 200	nA
A_{vd}	Large Signal Voltage Gain $V_{cc} = 15\text{V}$, $R_L = 2\text{k}$, $V_o = 1.4\text{V}$ to 11.4V $T_{min.} \leq T_{amb} \leq T_{max}$	50 25	100		V/mV
SVR	Supply Voltage Rejection Ratio $V_{cc} = 5\text{V}$ to 30V	65	100		dB
V_{icm}	Input Common Mode Voltage Range $V_{cc} = +30\text{V}$ – see note ¹⁾ $T_{min.} \leq T_{amb} \leq T_{max}$	0 0		$(V_{cc}^+) - 1.5$ $(V_{cc}^+) - 2$	V
CMR	Common Mode Rejection Ratio $T_{min.} \leq T_{amb} \leq T_{max}$	70 60	85		dB
I_{source}	Output Current Source $V_{cc} = +15\text{V}$, $V_o = 2\text{V}$, $V_{id} = +1\text{V}$	20	40		mA
I_o	Short Circuit to Ground $V_{cc} = +15\text{V}$		40	60	mA
I_{sink}	Output Current Sink $V_{id} = -1\text{V}$, $V_{cc} = +15\text{V}$, $V_o = 2\text{V}$	10	20		mA
V_{OH}	High Level Output Voltage $V_{cc}^+ = 30\text{V}$, $T_{amb} = 25\text{ }^\circ\text{C}$, $R_L = 10\text{k}$ $T_{min.} \leq T_{amb} \leq T_{max}$	27 27	28		V
V_{OL}	Low Level Output Voltage $R_L = 10\text{k}$ $T_{min.} \leq T_{amb} \leq T_{max}$		5	20 20	mV
SR	Slew Rate at Unity Gain $V_i = 0.5$ to 3V , $V_{cc} = 15\text{V}$ $R_L = 2\text{k}$, $C_L = 100\text{pF}$, unity gain	0.2	0.4		V/ μs
GBP	Gain Bandwidth Product $V_{cc} = 30\text{V}$, $R_L = 2\text{k}$, $C_L = 100\text{pF}$ $f = 100\text{kHz}$, $V_{in} = 10\text{mV}$	0.5	0.9		MHz
THD	Total Harmonic Distortion $f = 1\text{kHz}$ $A_v = 20\text{dB}$, $R_L = 2\text{k}$, $V_{cc} = 30\text{V}$ $C_L = 100\text{pF}$, $V_o = 2V_{pp}$		0.02		%

1 The input common-mode voltage of either input signal voltage should not be allowed to go negative by more than 0.3V. The upper end of the common-mode voltage range is $V_{cc}^+ - 1.5\text{V}$. But either of both inputs can go to +36V without damage.

OPERATOR 1 (op-amp with non-inverting input connected to the internal Vref)

 $V_{cc}^+ = +5\text{ V}$, $V_{cc} = \text{Ground}$, $T_{amb} = 25\text{ }^\circ\text{C}$ (unless otherwise specified)

Symbol	Parameter	Min	Typ	Max	Unit
V_{io}	Input Offset Voltage $V_{icm} = 0\text{ V}$ $T_{amb} = 25\text{ }^\circ\text{C}$ $T_{min} \leq T_{amb} \leq T_{max}$		0.5	3 5	mV
DV_{io}	Input Offset Voltage Drift			7	$\mu\text{V}/^\circ\text{C}$
I_{ib}	Input Bias Current Negative input		20		nA
A_{vd}	Large Signal Voltage Gain $V_{icm} = 0\text{ V}$ $V_{cc} = 15\text{ V}$, $R_L = 2\text{ k}$		100		V/mV
SVR	Supply Voltage Rejection Ratio $V_{icm} = 0\text{ V}$ $V_{cc}^+ = 5\text{ V to } 30\text{ V}$	65	100		dB
I_{source}	Output Current Source $V_o = 2\text{ V}$ $V_{cc} = +15\text{ V}$, $V_{id} = +1\text{ V}$	20	40		mA
I_o	Short Circuit to Ground $V_{cc} = +15\text{ V}$		40	60	mA
I_{sink}	Output Current Sink $V_{id} = -1\text{ V}$, $V_{cc} = +15\text{ V}$, $V_o = 2\text{ V}$	10	20		mA
V_{OH}	High Level Output Voltage $V_{cc}^+ = 30\text{ V}$, $T_{amb} = 25\text{ }^\circ\text{C}$, $R_L = 10\text{ k}$ $T_{min.} \leq T_{amb} \leq T_{max}$	27 27	28		V
V_{OL}	Low Level Output Voltage $R_L = 10\text{ k}$ $T_{min.} \leq T_{amb} \leq T_{max}$		5	20 20	mV
SR	Slew Rate at Unity Gain $V_i = 0.5\text{ to } 2\text{ V}$, $V_{cc} = 15\text{ V}$ $R_L = 2\text{ k}$, $C_L = 100\text{ pF}$, unity gain	0.2	0.4		V/ μs
GBP	Gain Bandwidth Product $V_{cc} = 30\text{ V}$, $R_L = 2\text{ k}$, $C_L = 100\text{ pF}$ $f = 100\text{ kHz}$, $V_{in} = 10\text{ mV}$	0.5	0.9		MHz
THD	Total Harmonic Distortion $f = 1\text{ kHz}$ $A_V = 20\text{ dB}$, $R_L = 2\text{ k}$, $V_{cc} = 30\text{ V}$ $C_L = 100\text{ pF}$, $V_o = 2\text{ V}_{pp}$		0.02		%

VOLTAGE REFERENCE

Symbol	Parameter	Value	Unit
I_k	Cathode Current	1 to 100	mA

Symbol	Parameter	Min	Typ	Max	Unit
V_{ref}	Reference Input Voltage $T_{amb} = 25\text{ }^{\circ}\text{C}$ $T_{min} \leq T_{amb} \leq T_{max}$	2.49 2.48	2.5	2.51 2.52	V
ΔV_{ref}	Reference Input Voltage Deviation Over Temperature Range $V_{KA} = V_{ref}, I_k = 10\text{mA}$ $T_{min} \leq T_{amb} \leq T_{max}$		5	24	mV
I_{min}	Minimum Cathode Current for Regulation $V_{KA} = V_{ref}$		0.5	1	mA
$ Z_{KA} $	Dynamic Impedance-note ¹⁾ $V_{KA} = V_{ref}, \Delta I_k = 1\text{ to }100\text{mA}, f < 1\text{kHz}$		0.2	0.5	Ω

1 The Dynamic impedance is defined as $|Z_{KA}| = \Delta V_{KA} / \Delta I_k$

Typical Performance Characteristics

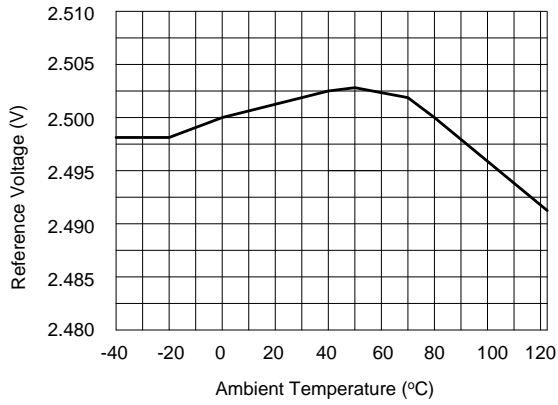

Figure 1. Reference Voltage vs. Ambient Temperature

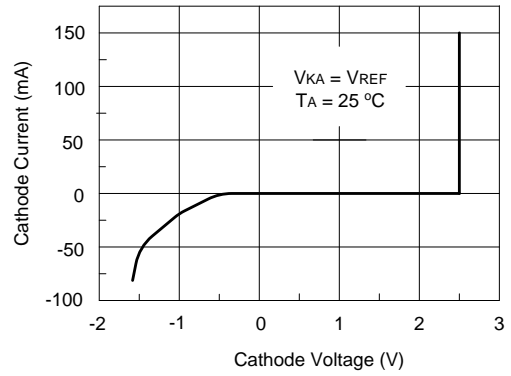

Figure 2. Cathode Current vs. Cathode Voltage

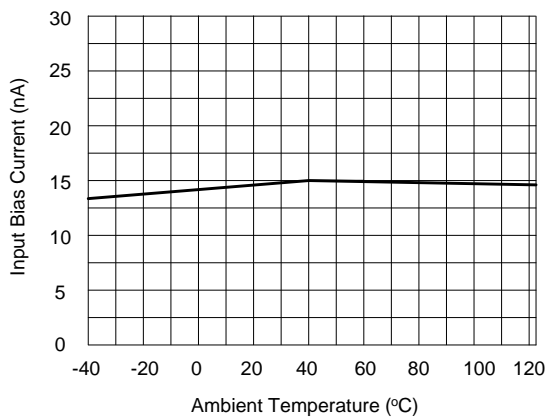

Figure 3. Input Bias Current vs. Ambient Temperature

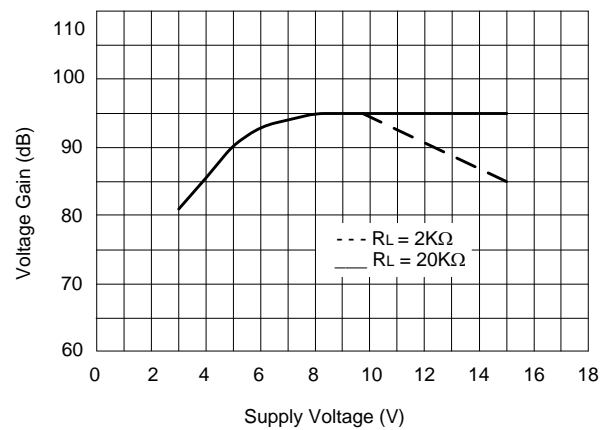
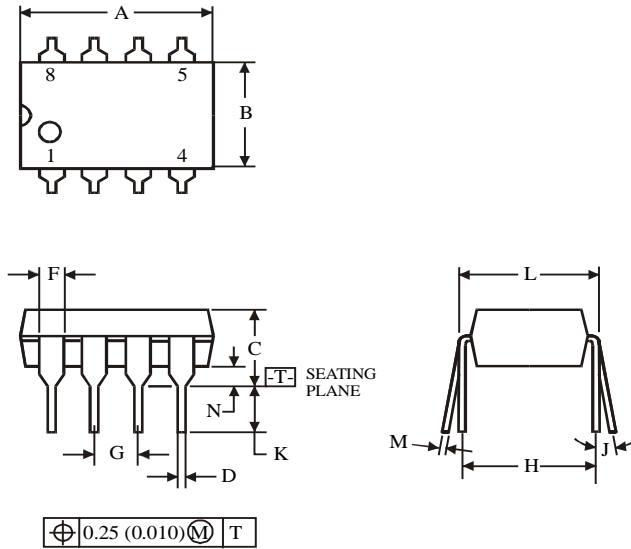
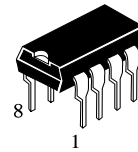

Figure 4. Operational Amplifier Voltage Gain

**N SUFFIX PLASTIC DIP
(MS - 001BA)**



Symbol	Dimension, mm	
	MIN	MAX
A	8.51	10.16
B	6.1	7.11
C		5.33
D	0.36	0.56
F	1.14	1.78
G	2.54	
H	7.62	
J	0°	10°
K	2.92	3.81
L	7.62	8.26
M	0.2	0.36
N	0.38	

NOTES:

- Dimensions "A", "B" do not include mold flash or protrusions.
Maximum mold flash or protrusions 0.25 mm (0.010) per side.

**D SUFFIX SOIC
(MS - 012AA)**

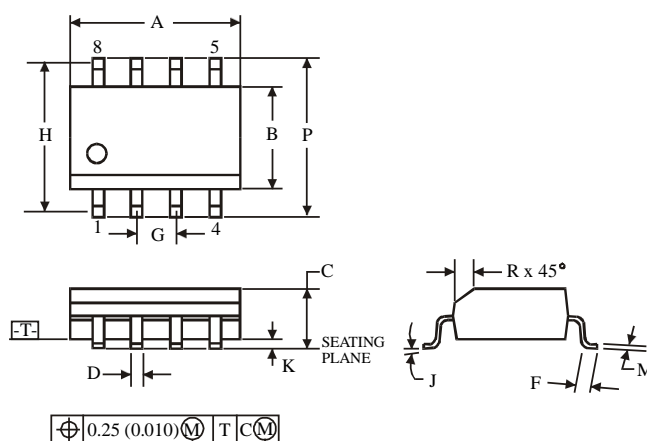
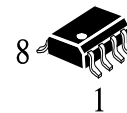

Symbol	Dimension, mm	
	MIN	MAX
A	4.8	5
B	3.8	4
C	1.35	1.75
D	0.33	0.51
F	0.4	1.27
G	1.27	
H	5.72	
J	0°	8°
K	0.1	0.25
M	0.19	0.25
P	5.8	6.2
R	0.25	0.5

NOTES:

- Dimensions A and B do not include mold flash or protrusion.
- Maximum mold flash or protrusion 0.15 mm (0.006) per side for A; for B - 0.25 mm (0.010) per side.