



SPN50T10

N-Channel Enhancement Mode MOSFET

DESCRIPTION

The SPN50T10 is the N-Channel logic enhancement mode power field effect transistor which is produced using super high cell density DMOS trench technology. The SPN80T10 has been designed specifically to improve the overall efficiency of DC/DC converters using either synchronous or conventional switching PWM controllers. It has been optimized for low gate charge, low $R_{DS(ON)}$ and fast switching speed.

FEATURES

- ◆ 100V/65A, $R_{DS(ON)}=18m\Omega@V_{GS}=10V$
- ◆ High density cell design for extremely low $R_{DS(ON)}$
- ◆ Exceptional on-resistance and maximum DC current capability
- ◆ TO-220 package design

APPLICATIONS

- Powered System
- DC/DC Converter
- Load Switch

PIN CONFIGURATION

TO-220

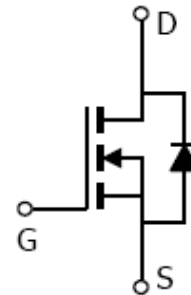
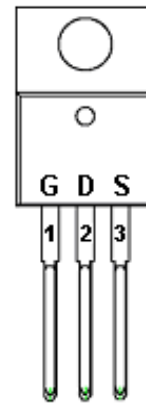

PART MARKING

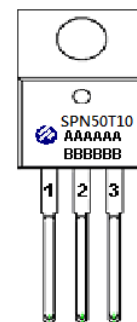

A : Lot Code
B : Date Code
(YY / MM / DD)



SPN50T10

N-Channel Enhancement Mode MOSFET

PIN DESCRIPTION

Pin	Symbol	Description
1	G	Gate
2	D	Drain
3	S	Source

ORDERING INFORMATION

Part Number	Package	Part Marking
SPN50T10T220TGB	TO-220-3L	SPN50T10

※ SPN50T10T220TGB : Tube ; Pb – Free ; Halogen - Free

ABSOLUTE MAXIMUM RATINGS

($T_A=25^{\circ}\text{C}$ Unless otherwise noted)

Parameter	Symbol	Typical	Unit
Drain-Source Voltage	V_{DSS}	100	V
Gate –Source Voltage	V_{GSS}	± 20	V
Continuous Drain Current($T_J=150^{\circ}\text{C}$)	I_D	$T_A=25^{\circ}\text{C}$ 65	A
		$T_A=70^{\circ}\text{C}$ 40	
Pulsed Drain Current	I_{DM}	200	A
Power Dissipation @ $T_A=25^{\circ}\text{C}$	P_D	166	W
Operating Junction Temperature	T_J	-55/150	$^{\circ}\text{C}$
Storage Temperature Range	T_{STG}	-55/150	$^{\circ}\text{C}$
Thermal Resistance-Junction to Ambient	$R_{\theta JA}$	62	$^{\circ}\text{C}/\text{W}$



SPN50T10

N-Channel Enhancement Mode MOSFET

ELECTRICAL CHARACTERISTICS

(TA=25°C Unless otherwise noted)

Parameter	Symbol	Conditions	Min.	Typ	Max.	Unit
Static						
Drain-Source Breakdown Voltage	$V_{(BR)DSS}$	$V_{GS}=0V, I_D=250\mu A$	100			V
Gate Threshold Voltage	$V_{GS(th)}$	$V_{DS}=V_{GS}, I_D=250\mu A$	2.0		4.0	
Gate Leakage Current	I_{GSS}	$V_{DS}=0V, V_{GS}=\pm 20V$			± 100	nA
Zero Gate Voltage Drain Current	I_{DSS}	$V_{DS}=80V, V_{GS}=0V$			25	uA
		$V_{DS}=80V, V_{GS}=0V$ $T_J=125^\circ C$			100	
Drain-Source On-Resistance	$R_{DS(on)}$	$V_{GS}=10V, I_D=30A$			18	mΩ
Forward Transconductance	g_{fs}	$V_{DS}=10V, I_D=30A$		75		S
Diode Forward Voltage	V_{SD}	$I_S=30A, V_{GS}=0V$			1.3	V
Dynamic						
Total Gate Charge	Q_g	$V_{DS}=80V, V_{GS}=10V$ $I_D=40A$		115	180	nC
Gate-Source Charge	Q_{gs}			20		
Gate-Drain Charge	Q_{gd}			48		
Input Capacitance	C_{iss}	$V_{DS}=25V, V_{GS}=0V$ $f=1MHz$		6000	9600	pF
Output Capacitance	C_{oss}			550		
Reverse Transfer Capacitance	C_{rss}			300		
Turn-On Time	$t_{d(on)}$	$V_{DD}=50V, R_L=1\Omega$ $I_D=30A, V_{GEN}=10V$ $R_G=1.66\Omega$		21		nS
	t_r			58		
Turn-Off Time	$t_{d(off)}$			41		
	t_f			15		



SPN50T10

N-Channel Enhancement Mode MOSFET

TYPICAL CHARACTERISTICS

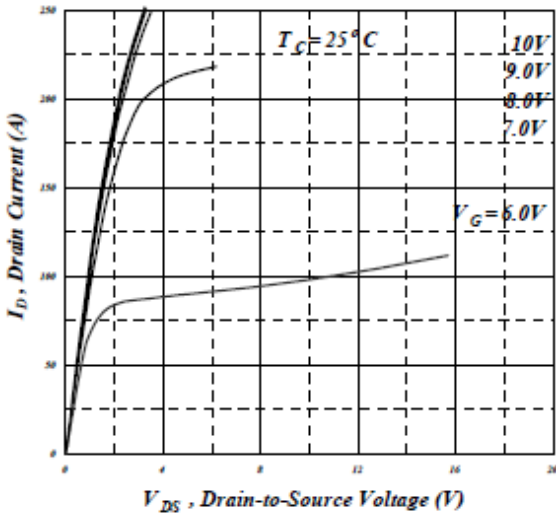

Fig 1. Typical Output Characteristics

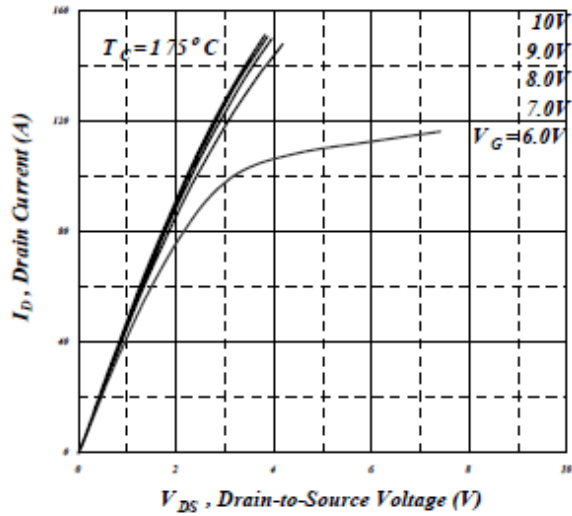

Fig 2. Typical Output Characteristics

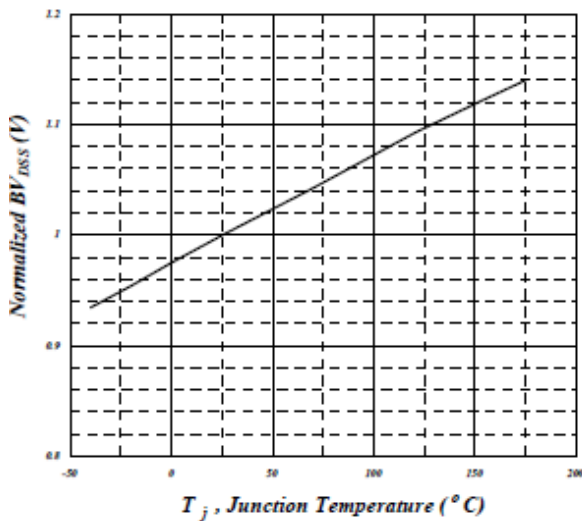

Fig 3. Normalized BV_{DSS} v.s. Junction Temperature

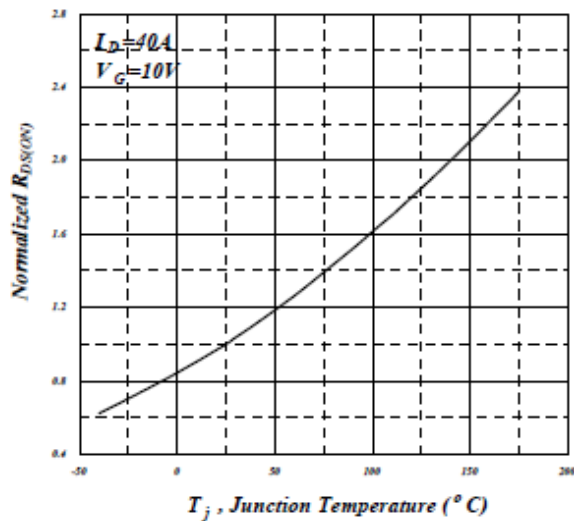

Fig 4. Normalized On-Resistance v.s. Junction Temperature



SPN50T10 N-Channel Enhancement Mode MOSFET

TYPICAL CHARACTERISTICS

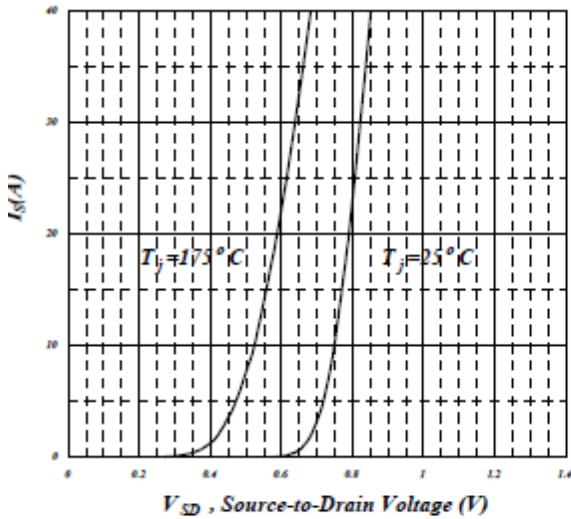

Fig 5. Forward Characteristic of Reverse Diode

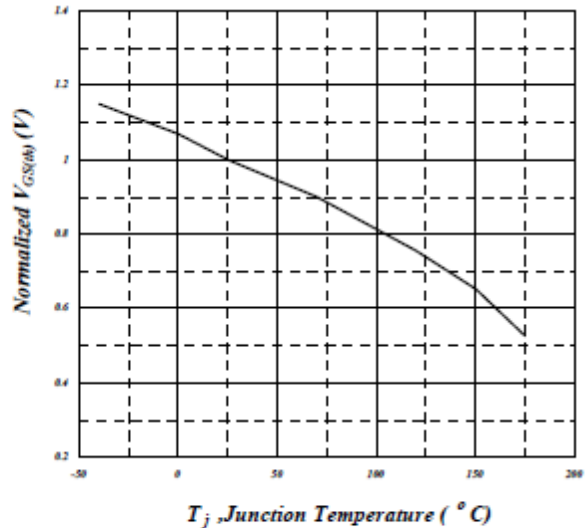

Fig 6. Gate Threshold Voltage v.s. Junction Temperature

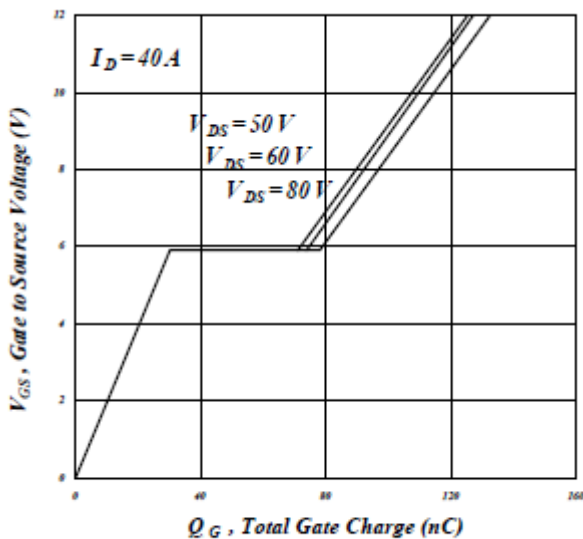

Fig 7. Gate Charge Characteristics

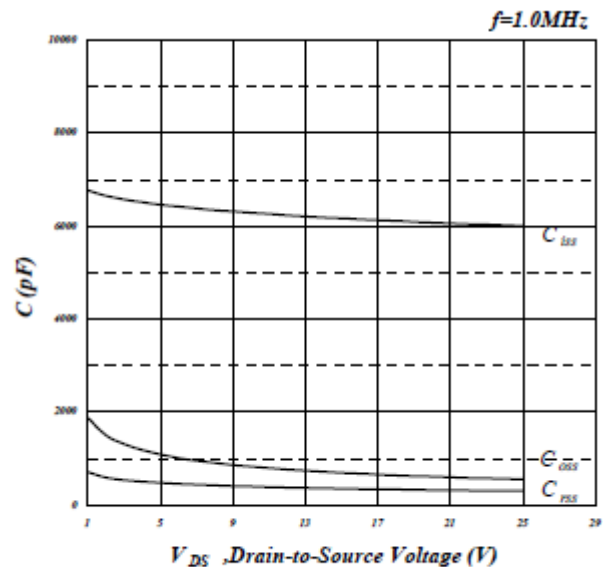

Fig 8. Typical Capacitance Characteristics



SPN50T10 N-Channel Enhancement Mode MOSFET

TYPICAL CHARACTERISTICS

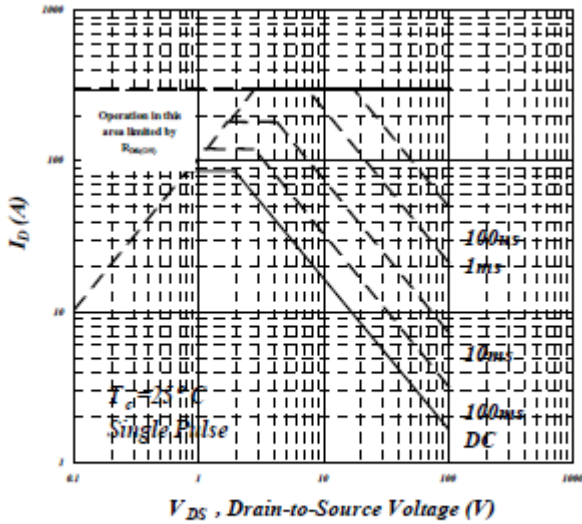

Fig 9. Maximum Safe Operating Area

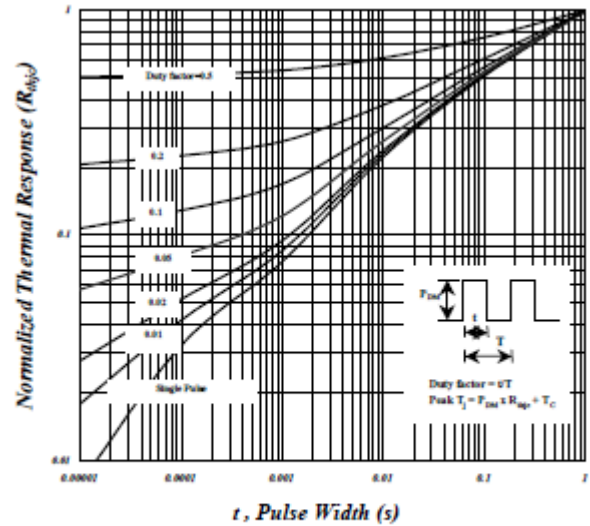

Fig 10. Effective Transient Thermal Impedance

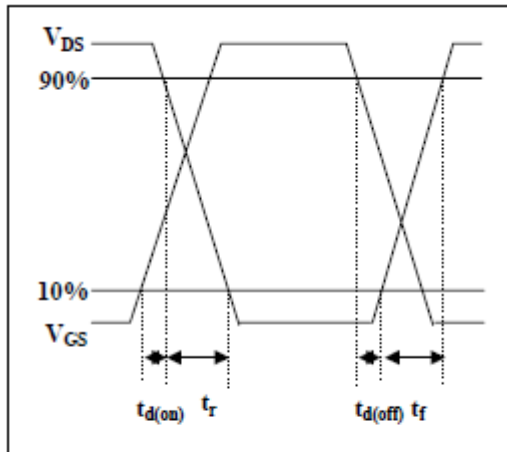

Fig 11. Switching Time Waveform

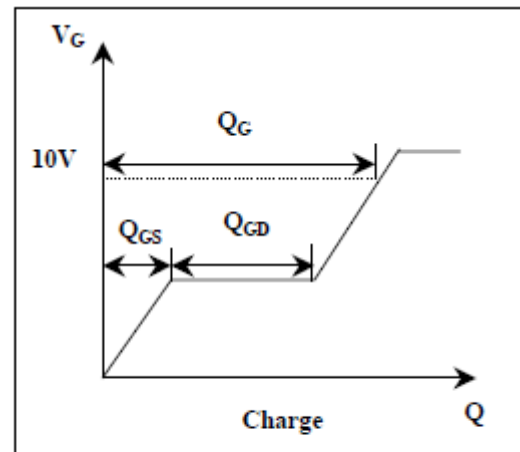

Fig 12. Gate Charge Waveform



SPN50T10

N-Channel Enhancement Mode MOSFET

TO-220 PACKAGE OUTLINE

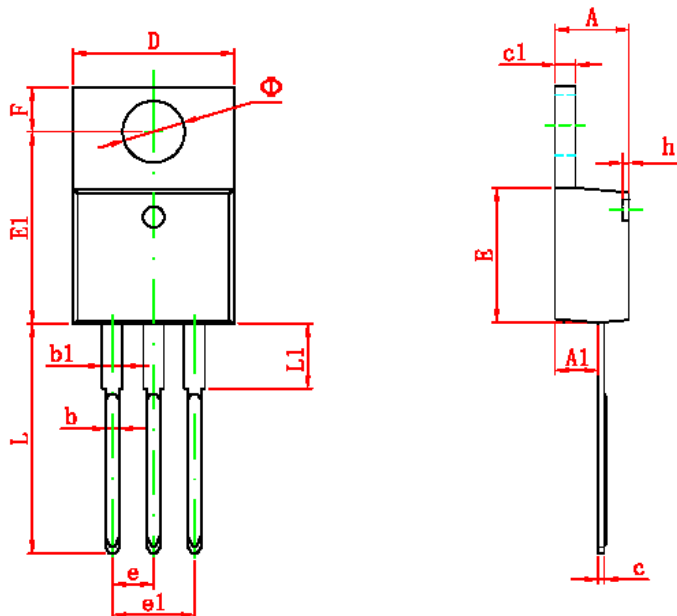

Symbol	Dimensions In Millimeters		Dimensions In Inches	
	Min	Max	Min	Max
A	4.470	4.670	0.176	0.184
A1	2.520	2.820	0.099	0.111
b	0.710	0.910	0.028	0.036
b1	1.170	1.370	0.046	0.054
c	0.310	0.530	0.012	0.021
c1	1.170	1.370	0.046	0.054
D	10.010	10.310	0.394	0.406
E	8.500	8.900	0.335	0.350
E1	12.060	12.460	0.475	0.491
e	2.540 TYP		0.100 TYP	
e1	4.980	5.180	0.196	0.204
F	2.590	2.890	0.102	0.114
h	0.000	0.300	0.000	0.012
L	13.400	13.800	0.528	0.543
L1	3.560	3.960	0.140	0.156
• •	3.735	3.935	0.147	0.155



SPN50T10

N-Channel Enhancement Mode MOSFET

Information provided is alleged to be exact and consistent. SYNC Power Corporation presumes no responsibility for the penalties of use of such information or for any violation of patents or other rights of third parties which may result from its use. No license is granted by allegation or otherwise under any patent or patent rights of SYNC Power Corporation. Conditions mentioned in this publication are subject to change without notice. This publication surpasses and replaces all information previously supplied. SYNC Power Corporation products are not authorized for use as critical components in life support devices or systems without express written approval of SYNC Power Corporation.

©The SYNC Power logo is a registered trademark of SYNC Power Corporation

©2004 SYNC Power Corporation – Printed in Taiwan – All Rights Reserved

SYNC Power Corporation

7F-2, No.3-1, Park Street

NanKang District (NKSP), Taipei, Taiwan 115

Phone: 886-2-2655-8178

Fax: 886-2-2655-8468

©<http://www.syncpower.com>