

<p>flowPIM 0</p> <div style="border: 1px solid black; padding: 5px; margin-bottom: 10px;"> <p style="text-align: center; background-color: #000080; color: white; margin: 0;">Features</p> <ul style="list-style-type: none"> Vincotech clip-in housing Trench Fieldstop IGBT's for low saturation losses Optional w/o BRC </div> <div style="border: 1px solid black; padding: 5px; margin-bottom: 10px;"> <p style="text-align: center; background-color: #000080; color: white; margin: 0;">Target Applications</p> <ul style="list-style-type: none"> Industrial drives Embedded drives </div> <div style="border: 1px solid black; padding: 5px;"> <p style="text-align: center; background-color: #000080; color: white; margin: 0;">Types</p> <ul style="list-style-type: none"> V23990-P546-A28-PM V23990-P546-A29-PM V23990-P546-C28-PM w/o BRC V23990-P546-C29-PM w/o BRC </div>	<p style="text-align: right;">600V/30A</p> <div style="border: 1px solid black; padding: 5px; margin-bottom: 10px;"> <p style="text-align: center; background-color: #000080; color: white; margin: 0;">flowPIM 0 housing</p> </div> <div style="border: 1px solid black; padding: 5px;"> <p style="text-align: center; background-color: #000080; color: white; margin: 0;">Schematic</p> </div>
---	--

Maximum Ratings

$T_j=25^{\circ}\text{C}$, unless otherwise specified

Parameter	Symbol	Condition	Value	Unit	
Input Rectifier Diode					
Repetitive peak reverse voltage	V_{RRM}		1600	V	
DC forward current	I_{FAV}	$T_j=T_{jmax}$	$T_h=80^{\circ}\text{C}$ $T_c=80^{\circ}\text{C}$	28 37	A
Surge forward current	I_{FSM}	$t_p=10\text{ms}$	$T_j=25^{\circ}\text{C}$	200	A
I2t-value	I^2t	50 Hz half sine wave		200	A^2s
Power dissipation per Diode	P_{tot}	$T_j=T_{jmax}$	$T_h=80^{\circ}\text{C}$ $T_c=80^{\circ}\text{C}$	33 50	W
Maximum Junction Temperature	T_{jmax}		150	$^{\circ}\text{C}$	
Inverter Transistor					
Collector-emitter break down voltage	V_{CE}		600	V	
DC collector current	I_C	$T_j=T_{jmax}$	$T_h=80^{\circ}\text{C}$ $T_c=80^{\circ}\text{C}$	27 36	A
Repetitive peak collector current	I_{Cpulse}	t_p limited by T_{jmax}	90	A	
Turn off safe operating area		$V_{CE} \leq 1200\text{V}$, $T_j \leq \text{Top max}$	90	A	
Power dissipation per IGBT	P_{tot}	$T_j=T_{jmax}$	$T_h=80^{\circ}\text{C}$ $T_c=80^{\circ}\text{C}$	54 82	W
Gate-emitter peak voltage	V_{GE}		± 20	V	
Short circuit ratings	t_{SC} V_{CC}	$T_j \leq 150^{\circ}\text{C}$ $V_{GE} = 15\text{V}$	6 360	μs V	
Maximum Junction Temperature	T_{jmax}		175	$^{\circ}\text{C}$	

Maximum Ratings

 $T_j=25^{\circ}\text{C}$, unless otherwise specified

Parameter	Symbol	Condition	Value	Unit
Inverter Diode				
Peak Repetitive Reverse Voltage	V_{RRM}		600	V
DC forward current	I_F	$T_j=T_{jmax}$ $T_h=80^{\circ}\text{C}$ $T_c=80^{\circ}\text{C}$	25 32	A
Repetitive peak forward current	I_{FRM}	t_p limited by T_{jmax}	60	A
Power dissipation per Diode	P_{tot}	$T_j=T_{jmax}$ $T_h=80^{\circ}\text{C}$ $T_c=80^{\circ}\text{C}$	40 60	W
Maximum Junction Temperature	T_{jmax}		175	$^{\circ}\text{C}$

Brake Transistor

Collector-emitter break down voltage	V_{CE}		600	V
DC collector current	I_C	$T_j=T_{jmax}$ $T_h=80^{\circ}\text{C}$ $T_c=80^{\circ}\text{C}$	21 27	A
Repetitive peak collector current	I_{Cpuls}	t_p limited by T_{jmax}	60	A
Turn off safe operating area		$V_{CE} \leq 1200\text{V}$, $T_j \leq \text{Top max}$	60	A
Power dissipation per IGBT	P_{tot}	$T_j=T_{jmax}$ $T_h=80^{\circ}\text{C}$ $T_c=80^{\circ}\text{C}$	41 63	W
Gate-emitter peak voltage	V_{GE}		± 20	V
Short circuit ratings	t_{SC} V_{CC}	$T_j \leq 150^{\circ}\text{C}$ $V_{GE} = 15\text{V}$	6 360	μs V
Maximum Junction Temperature	T_{jmax}		175	$^{\circ}\text{C}$

Brake Diode

Peak Repetitive Reverse Voltage	V_{RRM}		600	V
DC forward current	I_F	$T_j=T_{jmax}$ $T_h=80^{\circ}\text{C}$ $T_c=80^{\circ}\text{C}$	18 25	A
Repetitive peak forward current	I_{FRM}	t_p limited by T_{jmax}	40	A
Power dissipation per Diode	P_{tot}	$T_j=T_{jmax}$ $T_h=80^{\circ}\text{C}$ $T_c=80^{\circ}\text{C}$	31 47	W
Maximum Junction Temperature	T_{jmax}		175	$^{\circ}\text{C}$

Thermal Properties

Storage temperature	T_{stg}		-40...+125	$^{\circ}\text{C}$
Operation temperature under switching condition	T_{op}		-40...+($T_{jmax} - 25$)	$^{\circ}\text{C}$

Insulation Properties

Insulation voltage	V_{is}	$t=2\text{s}$ DC voltage	4000	V
Creepage distance			min 12,7	mm
Clearance			min 12,7	mm
Comparative tracking index	CTI		>200	

Characteristic Values

Parameter	Symbol	Conditions					Value			Unit
		$V_{GE}[V]$ or $V_{GS}[V]$	$V_i[V]$ or $V_{CE}[V]$ or $V_{DS}[V]$	$I_c[A]$ or $I_F[A]$ or $I_b[A]$	T_j	Min	Typ	Max		
Input Rectifier Diode										
Forward voltage	V_F			30	$T_j=25^\circ\text{C}$ $T_j=125^\circ\text{C}$	0,8	1,26 1,24	1,45		V
Threshold voltage (for power loss calc. only)	V_{to}			30	$T_j=25^\circ\text{C}$ $T_j=125^\circ\text{C}$		0,92 0,82			V
Slope resistance (for power loss calc. only)	r_t			30	$T_j=25^\circ\text{C}$ $T_j=125^\circ\text{C}$		11 14			m Ω
Reverse current	I_r		1500		$T_j=25^\circ\text{C}$ $T_j=145^\circ\text{C}$			1,1		mA
Thermal resistance chip to heatsink per chip	R_{thJH}	Thermal grease thickness $\leq 50\mu\text{m}$ $\lambda = 1 \text{ W/mK}$					2,10			K/W
Inverter Transistor										
Gate emitter threshold voltage	$V_{GE(th)}$	$V_{CE}=V_{GE}$		0,00043	$T_j=25^\circ\text{C}$ $T_j=150^\circ\text{C}$	5	5,8	6,5		V
Collector-emitter saturation voltage	$V_{CE(sat)}$		15	50	$T_j=25^\circ\text{C}$ $T_j=150^\circ\text{C}$	1,1	1,67 1,90	1,9		V
Collector-emitter cut-off current incl. Diode	I_{CES}		0	600	$T_j=25^\circ\text{C}$ $T_j=150^\circ\text{C}$			0,0016		mA
Gate-emitter leakage current	I_{GES}		20	0	$T_j=25^\circ\text{C}$ $T_j=150^\circ\text{C}$			300		nA
Integrated Gate resistor	R_{gint}						none			Ω
Turn-on delay time	$t_{d(on)}$	$R_{goff}=4 \Omega$ $R_{gon}=8 \Omega$	± 15	300	30	$T_j=25^\circ\text{C}$	17		ns	
Rise time	t_r					$T_i=150^\circ\text{C}$	18			
Turn-off delay time	$t_{d(off)}$					$T_j=25^\circ\text{C}$	16			
Fall time	t_f					$T_j=150^\circ\text{C}$	18			
Turn-on energy loss per pulse	E_{on}					$T_j=25^\circ\text{C}$	156			
Turn-off energy loss per pulse	E_{off}					$T_j=150^\circ\text{C}$	172			
Turn-on energy loss per pulse	E_{on}				$T_j=25^\circ\text{C}$		88		mWs	
Turn-off energy loss per pulse	E_{off}				$T_j=150^\circ\text{C}$		101			
Input capacitance	C_{ies}						1630		pF	
Output capacitance	C_{oss}	f=1MHz	0	25	$T_j=25^\circ\text{C}$		108			
Reverse transfer capacitance	C_{rss}						50			
Gate charge	Q_{Gate}		± 15	480	30	$T_j=25^\circ\text{C}$		167		nC
Thermal resistance chip to heatsink per chip	R_{thJH}	Thermal grease thickness $\leq 50\mu\text{m}$ $\lambda = 1 \text{ W/mK}$					1,76			K/W
Inverter Diode										
Diode forward voltage	V_F			30	$T_j=25^\circ\text{C}$ $T_j=150^\circ\text{C}$	1,25	1,64 1,66	1,95		V
Peak reverse recovery current	I_{RRM}				$T_j=25^\circ\text{C}$ $T_j=150^\circ\text{C}$		25 28			A
Reverse recovery time	t_{rr}				$T_j=25^\circ\text{C}$ $T_j=150^\circ\text{C}$		176 256			ns
Reverse recovered charge	Q_{rr}	$R_{gon}=8 \Omega$	± 15	300	30	$T_j=25^\circ\text{C}$ $T_j=150^\circ\text{C}$	1,36 2,45			μC
Peak rate of fall of recovery current	$di(\text{rec})_{\text{max}}/dt$					$T_j=25^\circ\text{C}$ $T_j=150^\circ\text{C}$	1521 932			A/ μs
Reverse recovered energy	E_{rec}					$T_j=25^\circ\text{C}$ $T_j=150^\circ\text{C}$	0,27 0,51			mWs
Thermal resistance chip to heatsink per chip	R_{thJH}	Thermal grease thickness $\leq 50\mu\text{m}$ $\lambda = 1 \text{ W/mK}$					2,40			K/W

Characteristic Values

Parameter	Symbol	Conditions					Value			Unit
		$V_{GE}[V]$ or $V_{GS}[V]$	$V_i[V]$ or $V_{CE}[V]$ or $V_{DS}[V]$	$I_c[A]$ or $I_F[A]$ or $I_b[A]$	T_j	Min	Typ	Max		
Brake Transistor										
Gate emitter threshold voltage	$V_{GE(th)}$	$V_{CE}=V_{GE}$			0,00029	$T_j=25^\circ C$ $T_j=150^\circ C$	5	5,8	6,5	V
Collector-emitter saturation voltage	$V_{CE(sat)}$		15		20	$T_j=25^\circ C$ $T_j=150^\circ C$	1	1,58 1,76	2,2	V
Collector-emitter cut-off incl diode	I_{CES}		0	600		$T_j=25^\circ C$ $T_j=150^\circ C$			0,0011	mA
Gate-emitter leakage current	I_{GES}		20	0		$T_j=25^\circ C$ $T_j=150^\circ C$			300	nA
Integrated Gate resistor	R_{gint}							none		Ω
Turn-on delay time	$t_{d(on)}$	$R_{goff}=8 \Omega$ $R_{gon}=16 \Omega$	± 15	300	20	$T_j=25^\circ C$		15		ns
Rise time	t_r					$T_j=150^\circ C$		14		
Turn-off delay time	$t_{d(off)}$					$T_j=25^\circ C$		12		
						$T_j=150^\circ C$		15		
Fall time	t_f					$T_j=25^\circ C$		197		
						$T_j=150^\circ C$		220		
Turn-on energy loss per pulse	E_{on}					$T_j=25^\circ C$ $T_j=150^\circ C$		0,31 0,43		mWs
Turn-off energy loss per pulse	E_{off}					$T_j=25^\circ C$ $T_j=150^\circ C$		0,53 0,67		
Input capacitance	C_{ies}	f=1MHz	0	25		$T_j=25^\circ C$		1100		pF
Output capacitance	C_{oss}							71		
Reverse transfer capacitance	C_{rss}							32		
Gate charge	Q_{Gate}		± 15	480	20	$T_j=25^\circ C$		120		nC
Thermal resistance chip to heatsink per chip	R_{thJH}	Thermal grease thickness $\leq 50\mu m$ $\lambda = 1 W/mK$						2,30		K/W
Brake Diode										
Diode forward voltage	V_F				20	$T_j=25^\circ C$ $T_j=150^\circ C$	1,25	1,83 1,76	1,95	V
Reverse leakage current	I_r	$R_{gon}=16 \Omega$		300		$T_j=25^\circ C$ $T_j=150^\circ C$			27	μA
Peak reverse recovery current	I_{RRM}	$R_{gon}=16 \Omega$	± 15	300	20	$T_j=25^\circ C$		18		A
Reverse recovery time	t_{rr}					$T_j=150^\circ C$		21		
						$T_j=25^\circ C$		31		
Reverse recovered charge	Q_{rr}					$T_j=150^\circ C$		197		
						$T_j=25^\circ C$		0,39		
Peak rate of fall of recovery current	$di(rec)max/dt$					$T_j=150^\circ C$		0,39		
		$T_j=25^\circ C$		1762						
Reverse recovery energy	E_{rec}					$T_j=25^\circ C$ $T_j=150^\circ C$		0,05 0,25		mWs
Thermal resistance chip to heatsink per chip	R_{thJH}	Thermal grease thickness $\leq 50\mu m$ $\lambda = 1 W/mK$						3,04		K/W
Thermistor										
Rated resistance	R					$T_j=25^\circ C$		21511		Ω
Deviation of R100	$\Delta R/R$	R100=1486 Ω				$T_c=100^\circ C$	-4,5		4,5	%
Power dissipation	P					$T_c=100^\circ C$		210		mW
Power dissipation constant						$T_j=25^\circ C$		3,5		mW/K
B-value	$B_{(25/50)}$	Tol. $\pm 3\%$				$T_j=25^\circ C$		3980		K
B-value	$B_{(25/100)}$	Tol. $\pm 3\%$				$T_j=25^\circ C$		3964		K
Vincotech NTC Reference						$T_j=25^\circ C$			A	

Output Inverter

Figure 1 Output inverter IGBT

Typical output characteristics

$$I_C = f(V_{CE})$$

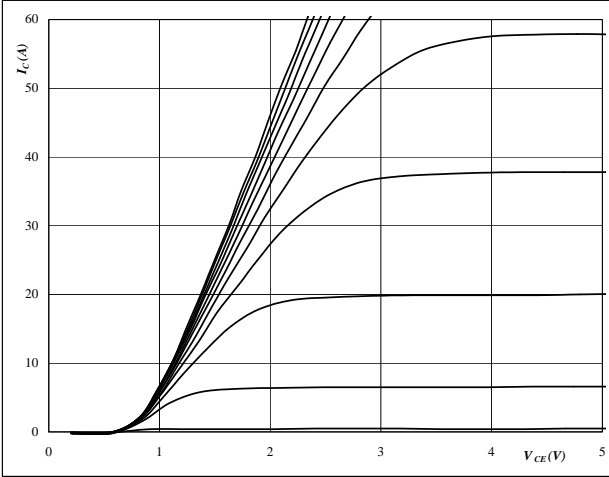

At

$t_p = 250 \mu s$
 $T_j = 25 \text{ }^\circ C$
 V_{GE} from 7 V to 17 V in steps of 1 V

Figure 2 Output inverter IGBT

Typical output characteristics

$$I_C = f(V_{CE})$$

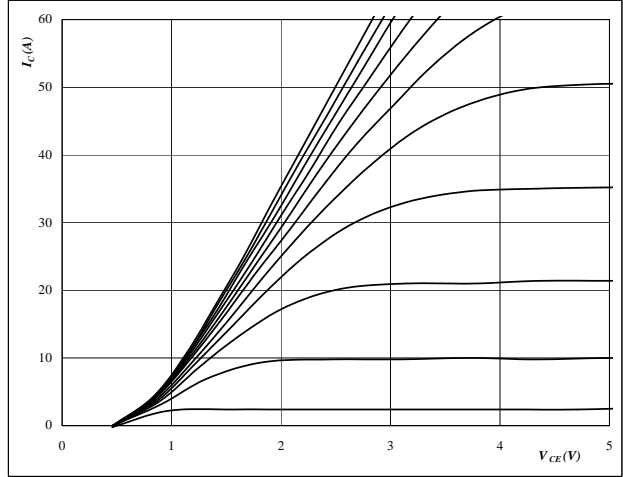

At

$t_p = 250 \mu s$
 $T_j = 125 \text{ }^\circ C$
 V_{GE} from 7 V to 17 V in steps of 1 V

Figure 3 Output inverter IGBT

Typical transfer characteristics

$$I_C = f(V_{GE})$$

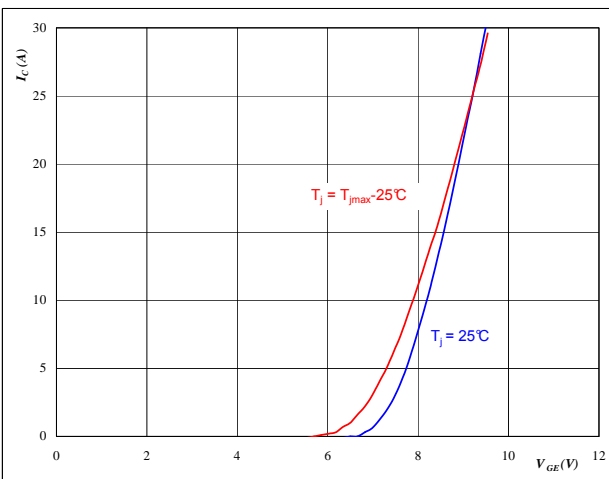

At

$t_p = 250 \mu s$
 $V_{CE} = 10 V$

Figure 4 Output inverter FWD

Typical diode forward current as a function of forward voltage

$$I_F = f(V_F)$$

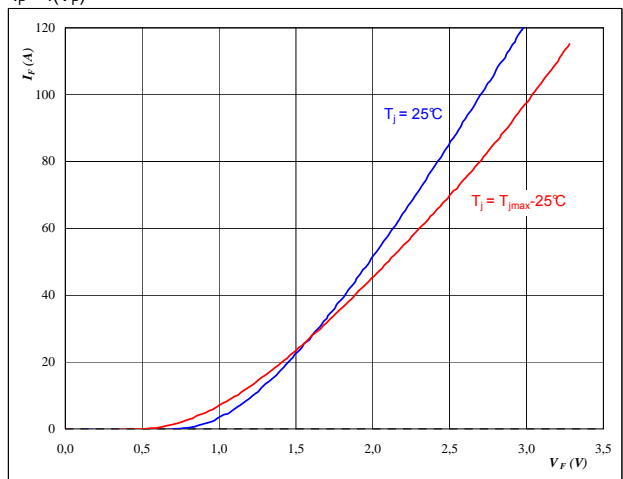

At

$t_p = 250 \mu s$

Output Inverter

Figure 5 Output inverter IGBT

Typical switching energy losses
as a function of collector current
 $E = f(I_C)$

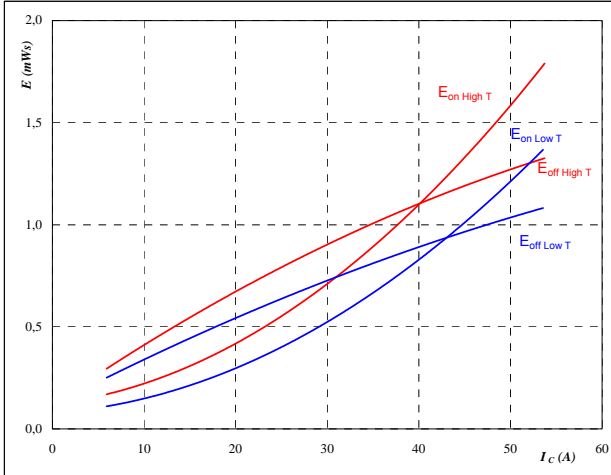

With an inductive load at
 $T_j = 25/125$ °C
 $V_{CE} = 300$ V
 $V_{GE} = 15$ V
 $R_{gon} = 8$ Ω
 $R_{goff} = 4$ Ω

Figure 6 Output inverter IGBT

Typical switching energy losses
as a function of gate resistor
 $E = f(R_G)$

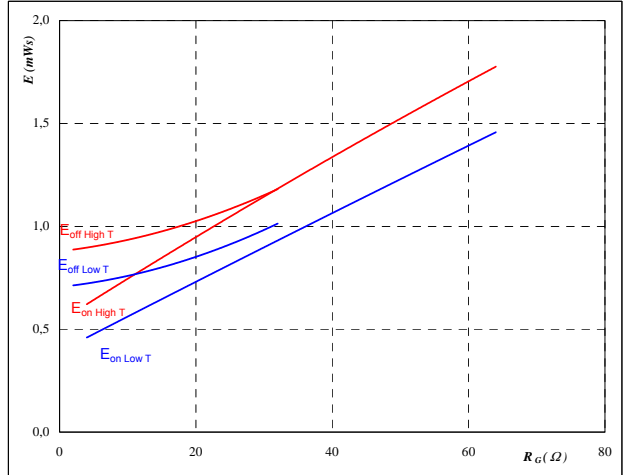

With an inductive load at
 $T_j = 25/125$ °C
 $V_{CE} = 300$ V
 $V_{GE} = 15$ V
 $I_C = 30$ A

Figure 7 Output inverter FWD

Typical reverse recovery energy loss
as a function of collector current
 $E_{rec} = f(I_C)$

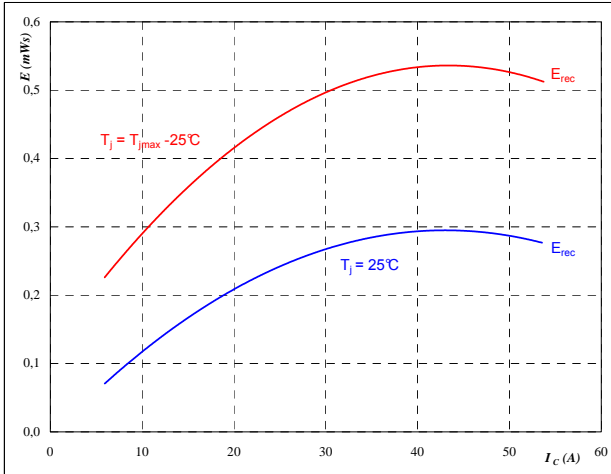

With an inductive load at
 $T_j = 25/125$ °C
 $V_{CE} = 300$ V
 $V_{GE} = 15$ V
 $R_{gon} = 8$ Ω

Figure 8 Output inverter FWD

Typical reverse recovery energy loss
as a function of gate resistor
 $E_{rec} = f(R_G)$

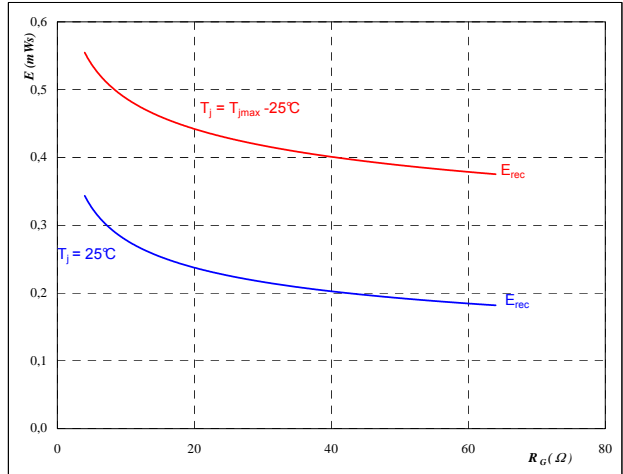

With an inductive load at
 $T_j = 25/125$ °C
 $V_{CE} = 300$ V
 $V_{GE} = 15$ V
 $I_C = 30$ A

Output Inverter

Figure 9 Output inverter IGBT

Typical switching times as a function of collector current

$$t = f(I_C)$$

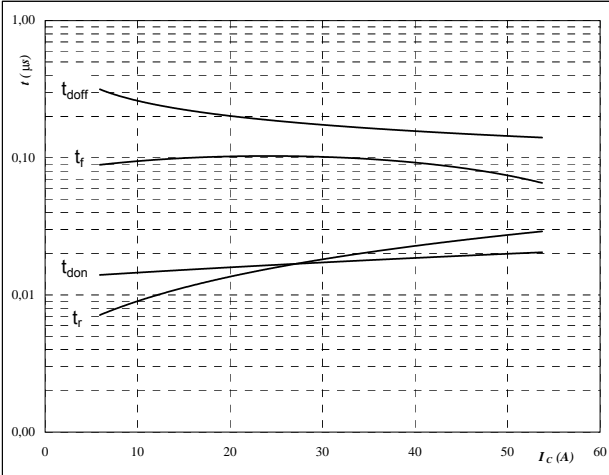

With an inductive load at

$T_j =$	125	°C
$V_{CE} =$	300	V
$V_{GE} =$	15	V
$R_{gon} =$	8	Ω
$R_{goff} =$	4	Ω

Figure 10 Output inverter IGBT

Typical switching times as a function of gate resistor

$$t = f(R_G)$$

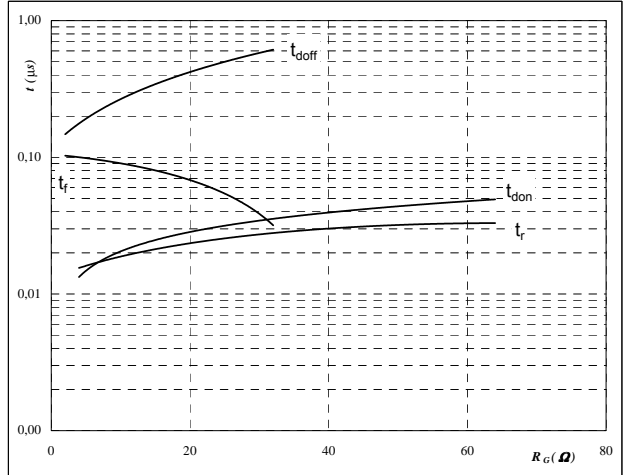

With an inductive load at

$T_j =$	125	°C
$V_{CE} =$	300	V
$V_{GE} =$	15	V
$I_C =$	30	A

Figure 11 Output inverter FWD

Typical reverse recovery time as a function of collector current

$$t_{rr} = f(I_C)$$

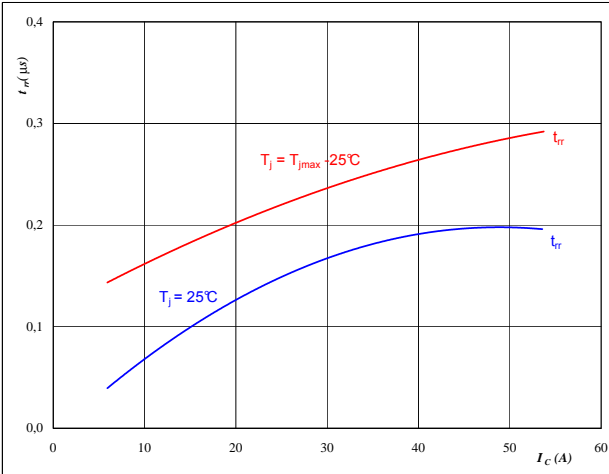

At

$T_j =$	25/125	°C
$V_{CE} =$	300	V
$V_{GE} =$	15	V
$R_{gon} =$	8	Ω

Figure 12 Output inverter FWD

Typical reverse recovery time as a function of IGBT turn on gate resistor

$$t_{rr} = f(R_{gon})$$

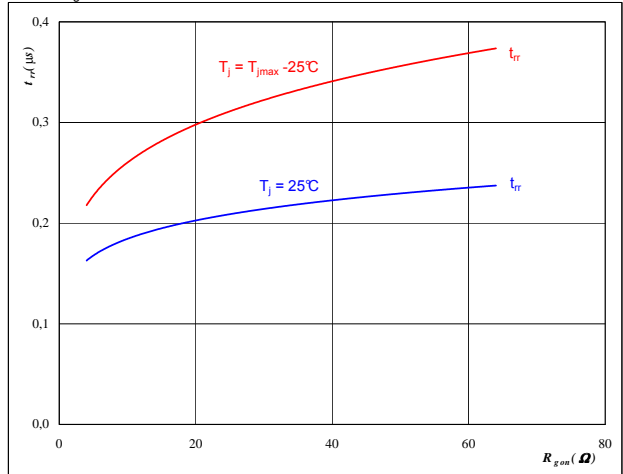

At

$T_j =$	25/125	°C
$V_R =$	300	V
$I_F =$	30	A
$V_{GE} =$	15	V

Output Inverter

Figure 13 Output inverter FWD

Typical reverse recovery charge as a function of collector current

$$Q_{rr} = f(I_C)$$

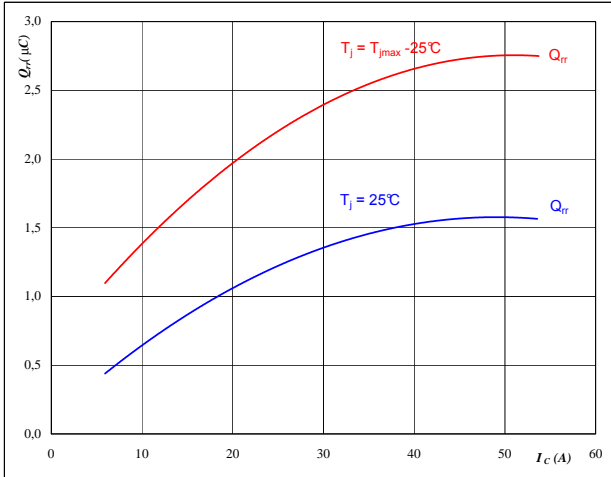

At
 $T_j = 25/125$ °C
 $V_{CE} = 300$ V
 $V_{GE} = 15$ V
 $R_{gon} = 8$ Ω

Figure 14 Output inverter FWD

Typical reverse recovery charge as a function of IGBT turn on gate resistor

$$Q_{rr} = f(R_{gon})$$

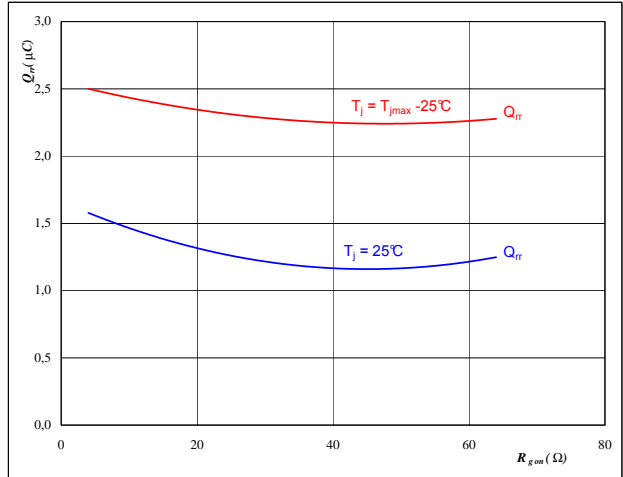

At
 $T_j = 25/125$ °C
 $V_R = 300$ V
 $I_F = 30$ A
 $V_{GE} = 15$ V

Figure 15 Output inverter FWD

Typical reverse recovery current as a function of collector current

$$I_{RRM} = f(I_C)$$

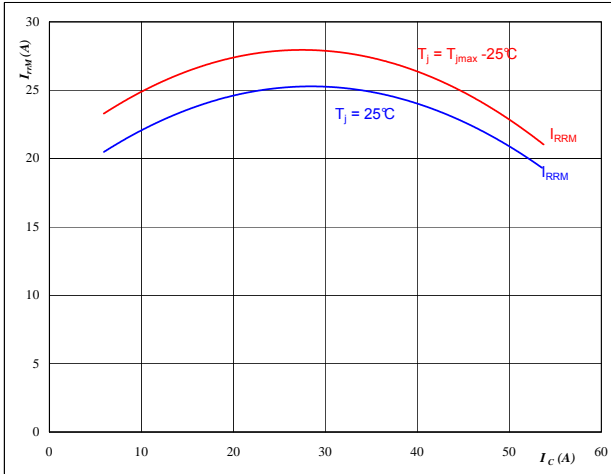

At
 $T_j = 25/125$ °C
 $V_{CE} = 300$ V
 $V_{GE} = 15$ V
 $R_{gon} = 8$ Ω

Figure 16 Output inverter FWD

Typical reverse recovery current as a function of IGBT turn on gate resistor

$$I_{RRM} = f(R_{gon})$$

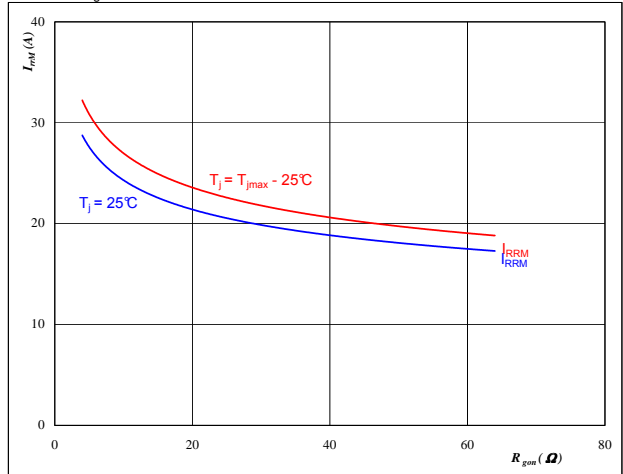

At
 $T_j = 25/125$ °C
 $V_R = 300$ V
 $I_F = 30$ A
 $V_{GE} = 15$ V

Output Inverter

Figure 17 Output inverter FWD

Typical rate of fall of forward and reverse recovery current as a function of collector current

$$di_f/dt, di_{rec}/dt = f(I_C)$$

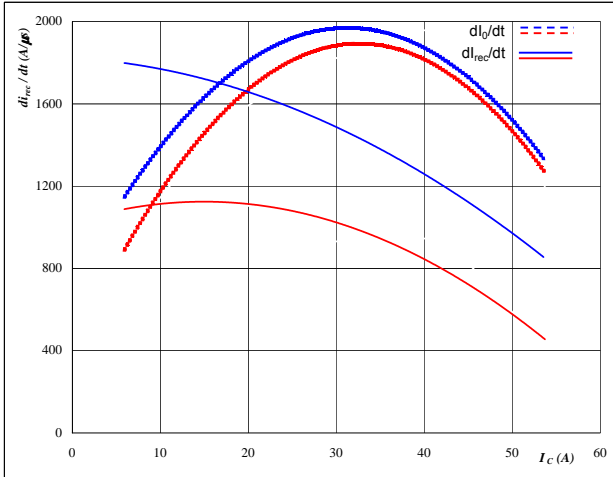

At
 $T_j = 25/125$ °C
 $V_{CE} = 300$ V
 $V_{GE} = 15$ V
 $R_{gon} = 8$ Ω

Figure 18 Output inverter FWD

Typical rate of fall of forward and reverse recovery current as a function of IGBT turn on gate resistor

$$di_f/dt, di_{rec}/dt = f(R_{gon})$$

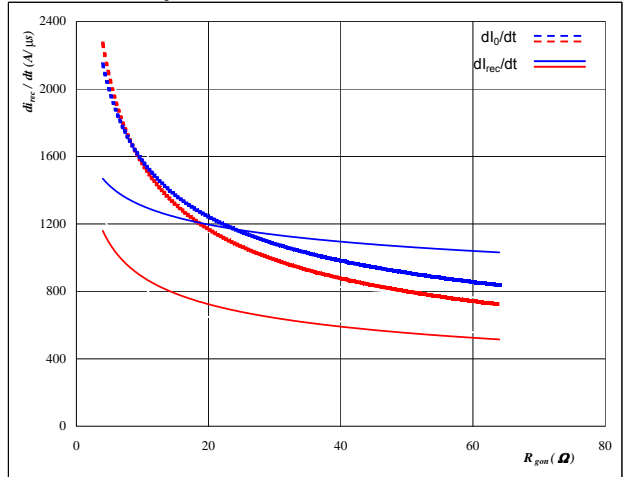

At
 $T_j = 25/125$ °C
 $V_R = 300$ V
 $I_F = 30$ A
 $V_{GE} = 15$ V

Figure 19 Output inverter IGBT

IGBT transient thermal impedance as a function of pulse width

$$Z_{th,JH} = f(t_p)$$

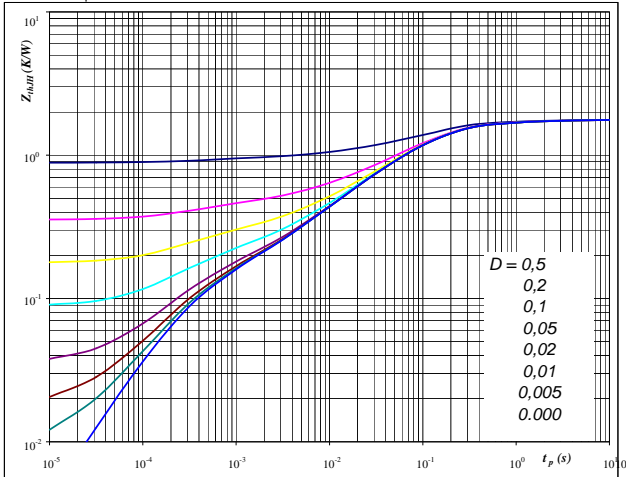

At
 $D = t_p / T$
 $R_{th,JH} = 1,76$ K/W $1,43$

IGBT thermal model values

Thermal grease		Phase change interface	
R (C/W)	Tau (s)	R (C/W)	Tau (s)
0,06	4,6E+00	0,05	3,7E+00
0,22	5,4E-01	0,17	4,3E-01
0,94	1,0E-01	0,76	8,4E-02
0,34	2,0E-02	0,27	1,6E-02
0,11	3,1E-03	0,09	2,5E-03
0,11	3,0E-04	0,09	2,4E-04

Figure 20 Output inverter FWD

FWD transient thermal impedance as a function of pulse width

$$Z_{th,JH} = f(t_p)$$

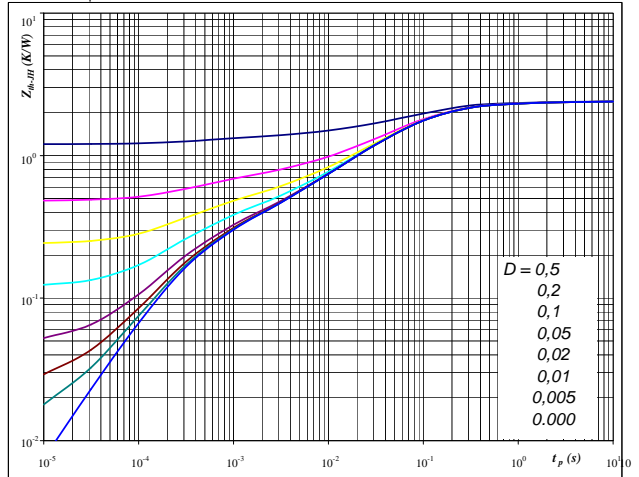

At
 $D = t_p / T$
 $R_{th,JH} = 2,40$ K/W $1,94$

FWD thermal model values

Thermal grease		Phase change interface	
R (C/W)	Tau (s)	R (C/W)	Tau (s)
0,07	4,6E+00	0,06	3,7E+00
0,27	4,8E-01	0,22	3,9E-01
1,13	8,5E-02	0,92	6,9E-02
0,52	2,0E-02	0,42	1,6E-02
0,20	2,8E-03	0,16	2,3E-03
0,21	3,3E-04	0,17	2,7E-04

Output Inverter

Figure 21 Output inverter IGBT

Power dissipation as a function of heatsink temperature

$$P_{tot} = f(T_h)$$

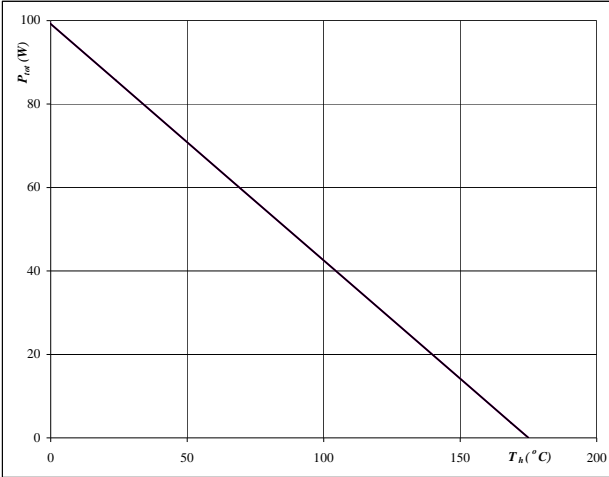

At $T_j = 175$ °C

Figure 22 Output inverter IGBT

Collector current as a function of heatsink temperature

$$I_C = f(T_h)$$

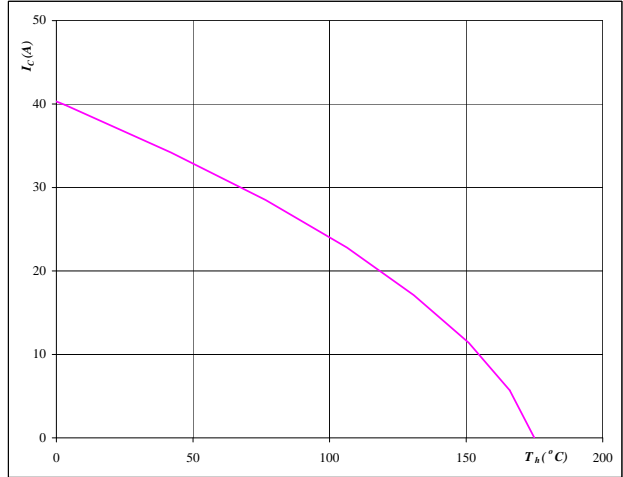

At $T_j = 175$ °C
 $V_{GE} = 15$ V

Figure 23 Output inverter FWD

Power dissipation as a function of heatsink temperature

$$P_{tot} = f(T_h)$$

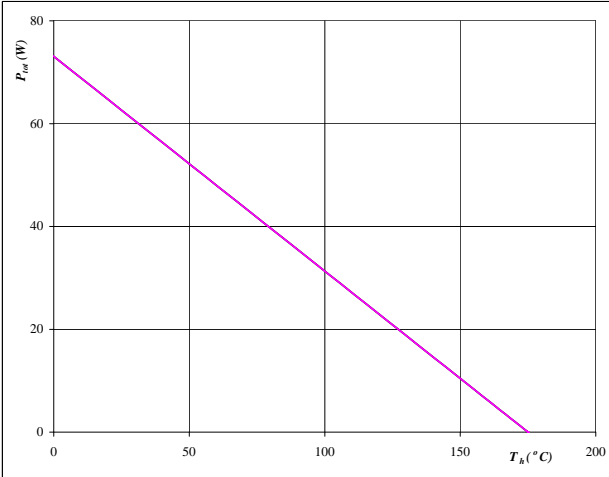

At $T_j = 175$ °C

Figure 24 Output inverter FWD

Forward current as a function of heatsink temperature

$$I_F = f(T_h)$$

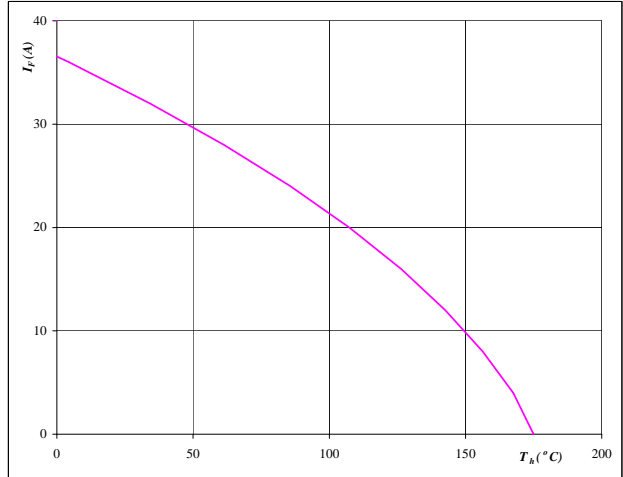

At $T_j = 175$ °C

Output Inverter

Figure 25 Output inverter IGBT

Safe operating area as a function of collector-emitter voltage

$$I_C = f(V_{CE})$$

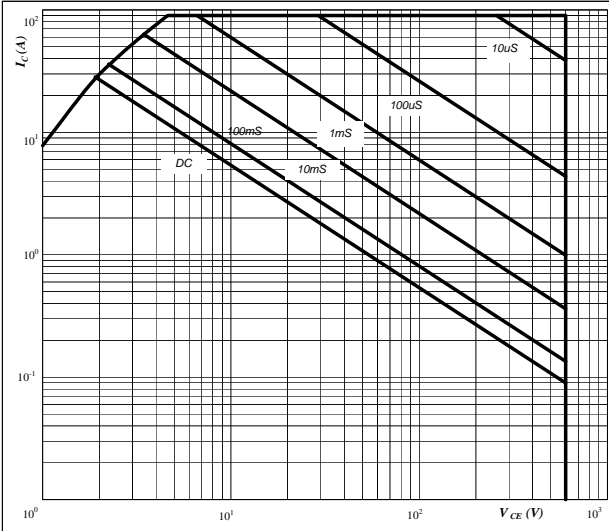

At
 D = single pulse
 $T_h = 80$ °C
 $V_{GE} = 15$ V
 $T_j = T_{jmax}$ °C

Figure 26 Output inverter IGBT

Gate voltage vs Gate charge

$$V_{GE} = f(Q_{GE})$$

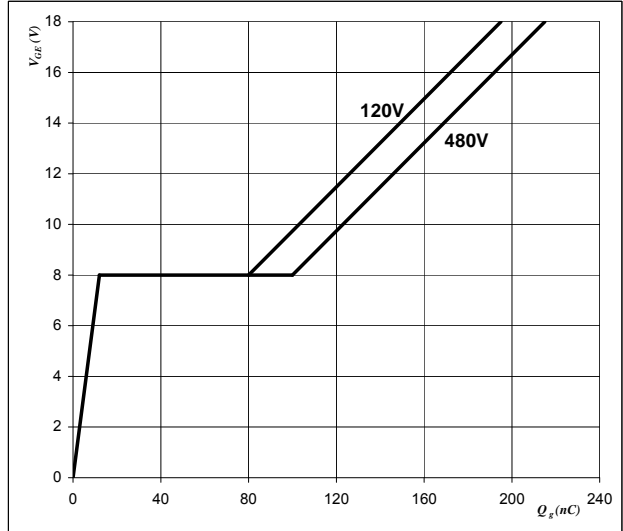

At
 $I_C = 30$ A

Figure 27 Output inverter IGBT

Short circuit withstand time as a function of gate-emitter voltage

$$t_{sc} = f(V_{GE})$$

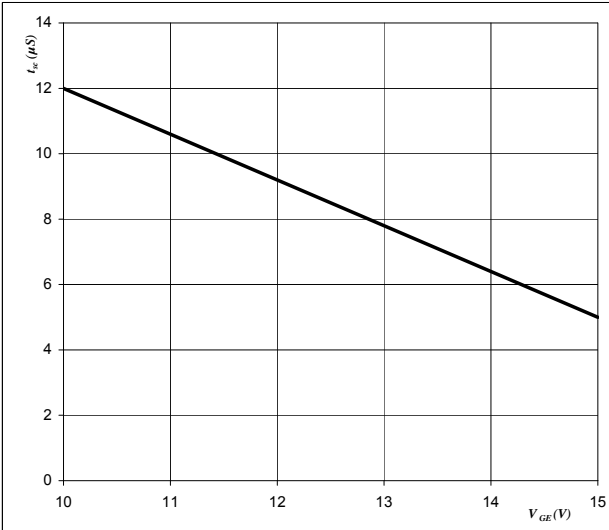

At
 $V_{CE} = 600$ V
 $T_j \leq 175$ °C

Figure 28 Output inverter IGBT

Typical short circuit collector current as a function of gate-emitter voltage

$$V_{GE} = f(Q_{GE})$$

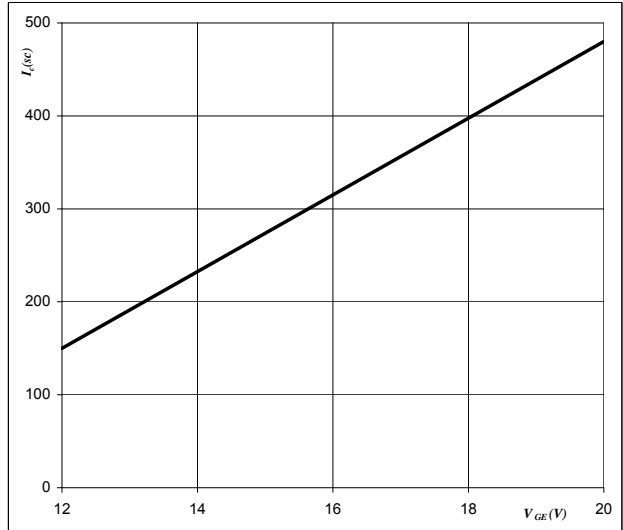

At
 $V_{CE} \leq 600$ V
 $T_j = 175$ °C

Figure 29 IGBT
Reverse bias safe operating area

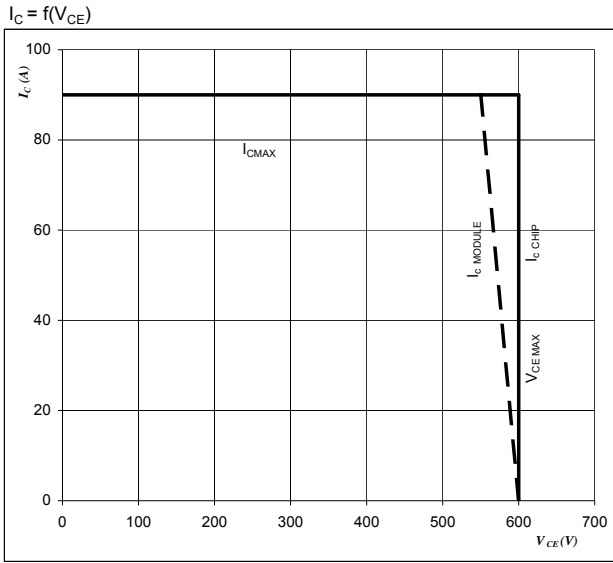

At

$$T_j = T_{j,max} - 25 \text{ } ^\circ\text{C}$$

$$U_{ccminus} = U_{ccplus}$$

Switching mode : 3phase SPWM

Brake

Figure 1 Brake IGBT

Typical output characteristics

$I_C = f(V_{CE})$



At
 $t_p = 250 \mu s$
 $T_j = 25 \text{ } ^\circ C$
 V_{GE} from 7 V to 17 V in steps of 1 V

Figure 2 Brake IGBT

Typical output characteristics

$I_C = f(V_{CE})$

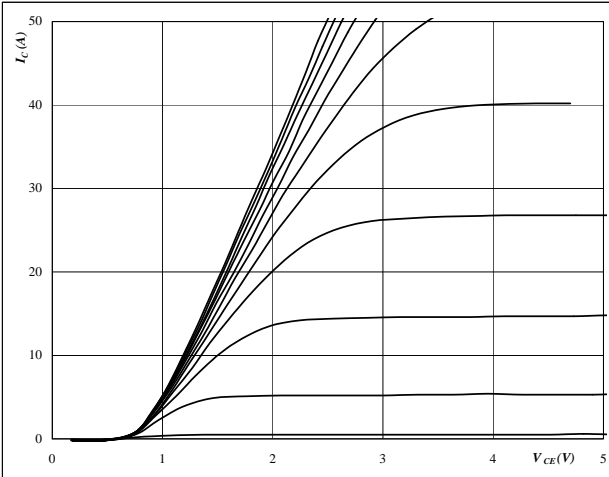

At
 $t_p = 250 \mu s$
 $T_j = 125 \text{ } ^\circ C$
 V_{GE} from 7 V to 17 V in steps of 1 V

Figure 3 Brake IGBT

Typical transfer characteristics

$I_C = f(V_{GE})$

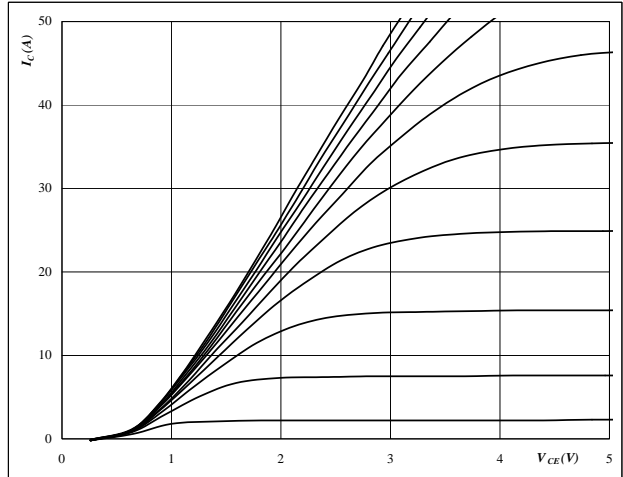
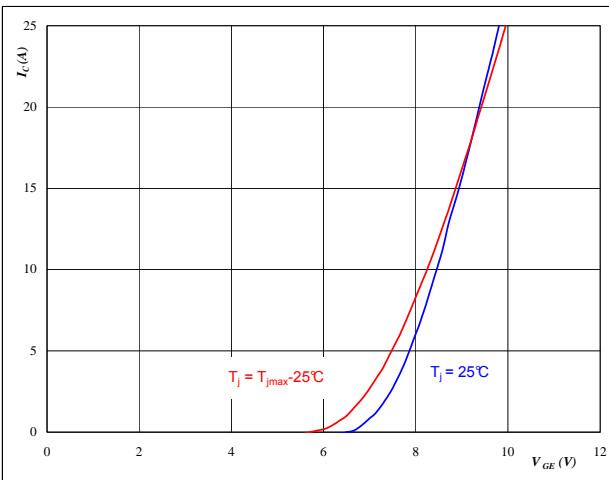
At
 $t_p = 250 \mu s$
 $V_{CE} = 10 \text{ V}$
Figure 4 Brake FWD

Typical diode forward current as a function of forward voltage

$I_F = f(V_F)$

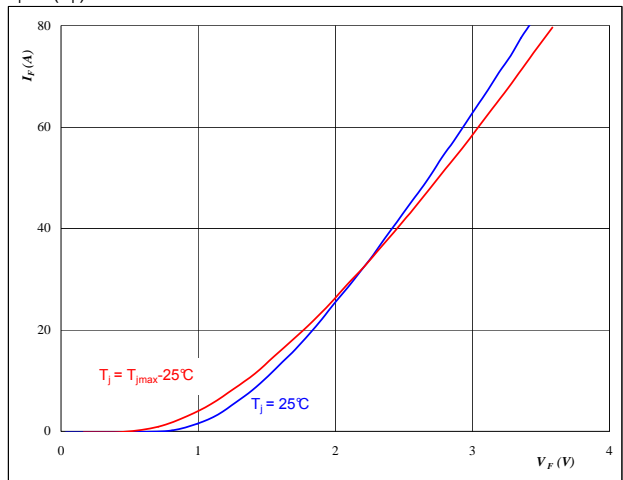

At
 $t_p = 250 \mu s$

Brake

Figure 5 Brake IGBT

Typical switching energy losses
as a function of collector current

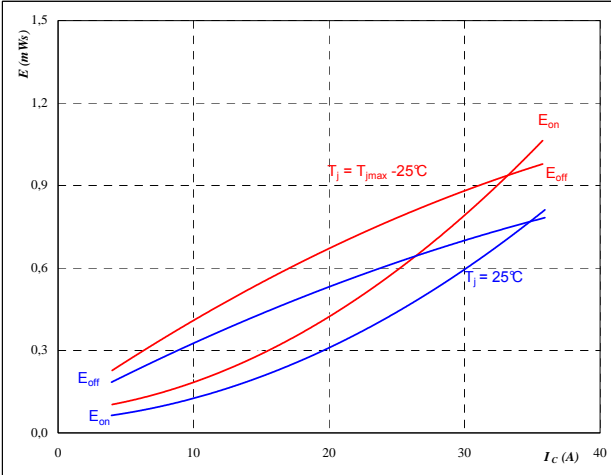
$$E = f(I_C)$$



With an inductive load at

$T_j = 25/125$ °C
 $V_{CE} = 300$ V
 $V_{GE} = 15$ V
 $R_{gon} = 16$ Ω
 $R_{goff} = 8$ Ω

Figure 6 Brake IGBT

Typical switching energy losses
as a function of gate resistor

$$E = f(R_G)$$

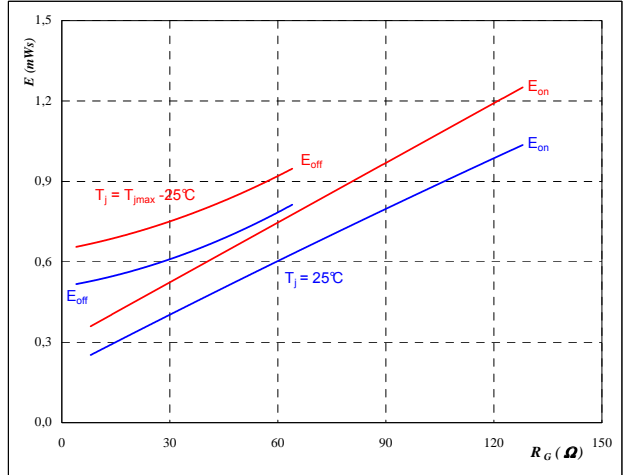

With an inductive load at

$T_j = 25/125$ °C
 $V_{CE} = 300$ V
 $V_{GE} = 15$ V
 $I_C = 20$ A

Figure 7 Brake FWD

Typical reverse recovery energy loss
as a function of collector current

$$E_{rec} = f(I_C)$$

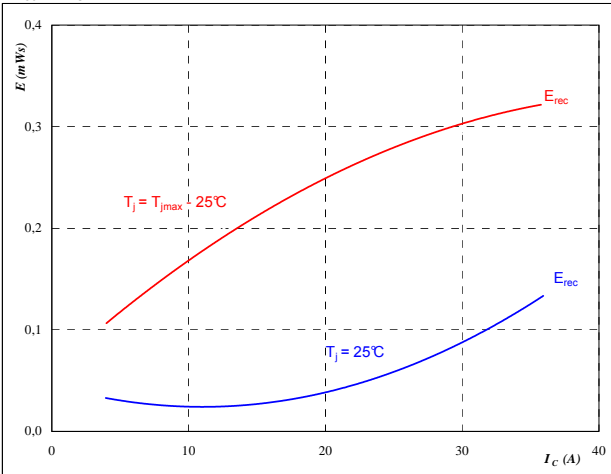

With an inductive load at

$T_j = 25/125$ °C
 $V_{CE} = 300$ V
 $V_{GE} = 15$ V
 $R_{gon} = 16$ Ω

Figure 8 Brake FWD

Typical reverse recovery energy loss
as a function of gate resistor

$$E_{rec} = f(R_G)$$

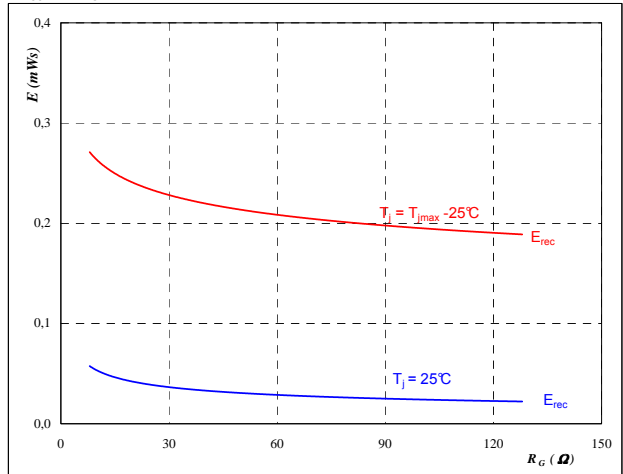

With an inductive load at

$T_j = 25/125$ °C
 $V_{CE} = 300$ V
 $V_{GE} = 15$ V
 $I_C = 20$ A

Brake

Figure 9 Brake IGBT

Typical switching times as a function of collector current

$t = f(I_C)$

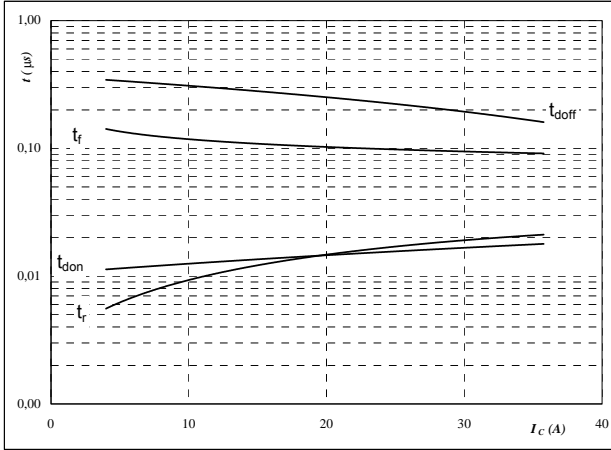

With an inductive load at
 $T_j = 25/125$ °C
 $V_{CE} = 300$ V
 $V_{GE} = 15$ V
 $R_{gon} = 16$ Ω
 $R_{goff} = 8$ Ω

Figure 10 Brake IGBT

Typical switching times as a function of gate resistor

$t = f(R_G)$

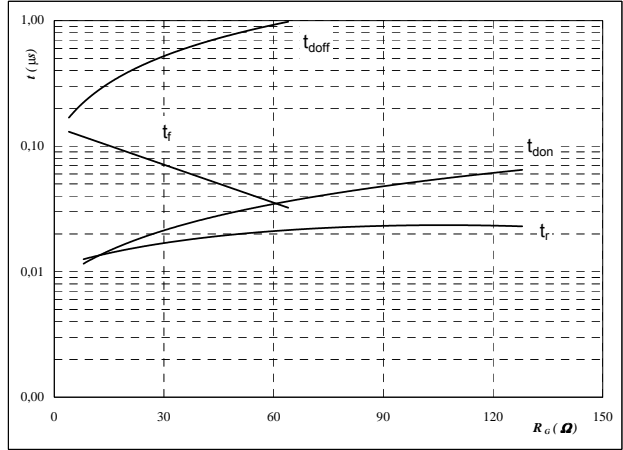

With an inductive load at
 $T_j = 25/125$ °C
 $V_{CE} = 300$ V
 $V_{GE} = 15$ V
 $I_C = 20$ A

Figure 11 Brake IGBT

IGBT transient thermal impedance as a function of pulse width

$Z_{thJH} = f(t_p)$

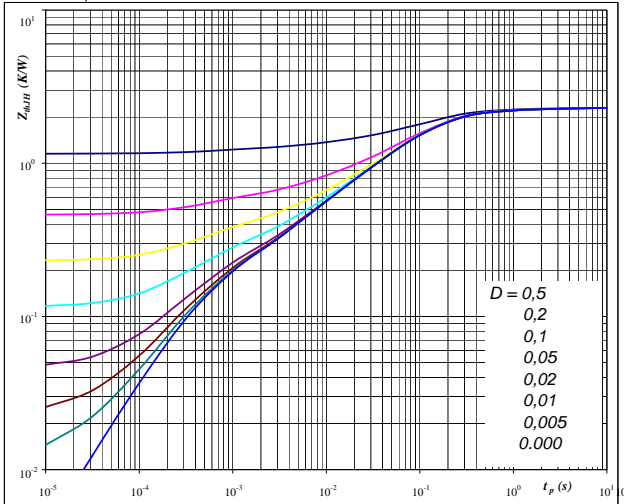

At Thermal grease $R_{thJH} = 2,30$ K/W
 D = t_p / T
 Phase change interface $R_{thJH} = 0,60$ K/W

Figure 12 Brake FWD

FWD transient thermal impedance as a function of pulse width

$Z_{thJH} = f(t_p)$

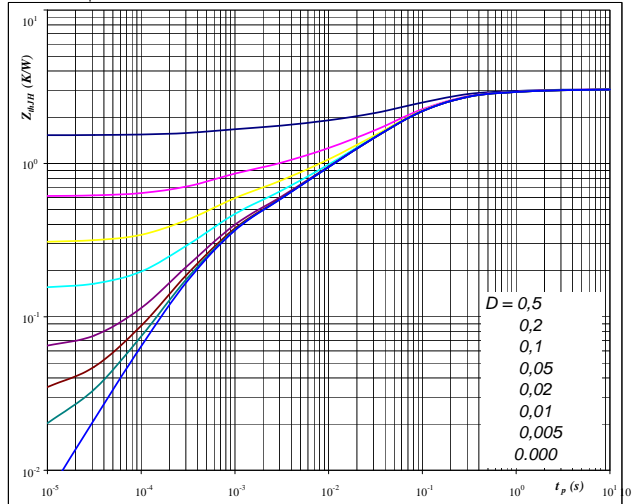

At Thermal grease $R_{thJH} = 3,04$ K/W
 D = t_p / T
 Phase change interface $R_{thJH} = 1,27$ K/W

Brake

Figure 13 Brake IGBT

Power dissipation as a function of heatsink temperature

$$P_{tot} = f(T_h)$$

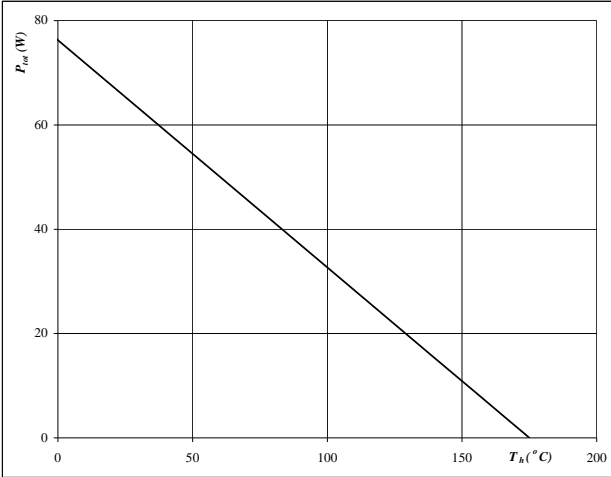

At
 $T_j = 175$ °C

Figure 14 Brake IGBT

Collector current as a function of heatsink temperature

$$I_C = f(T_h)$$

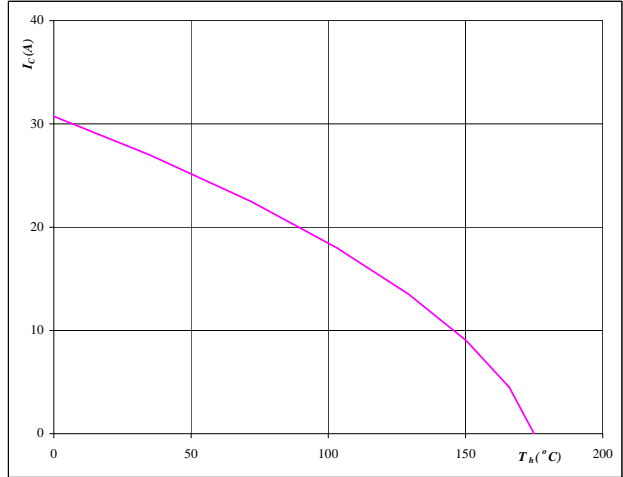

At
 $T_j = 175$ °C
 $V_{GE} = 15$ V

Figure 15 Brake FWD

Power dissipation as a function of heatsink temperature

$$P_{tot} = f(T_h)$$

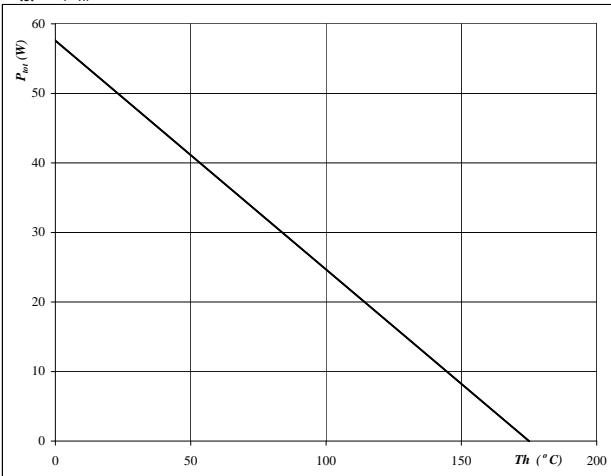

At
 $T_j = 175$ °C

Figure 16 Brake FWD

Forward current as a function of heatsink temperature

$$I_F = f(T_h)$$

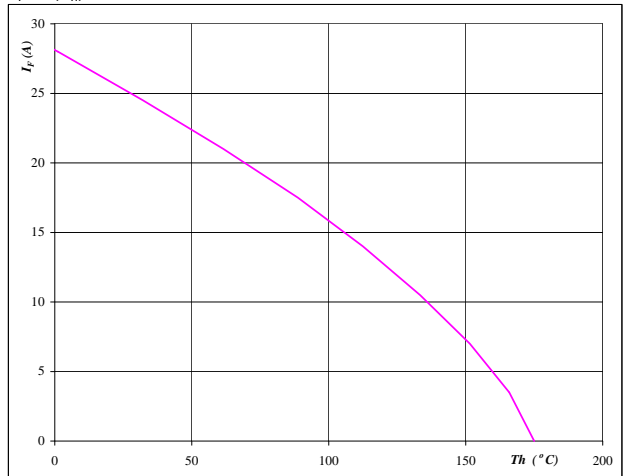

At
 $T_j = 175$ °C

Input Rectifier Bridge

Figure 1 Rectifier diode

Typical diode forward current as a function of forward voltage

$$I_F = f(V_F)$$

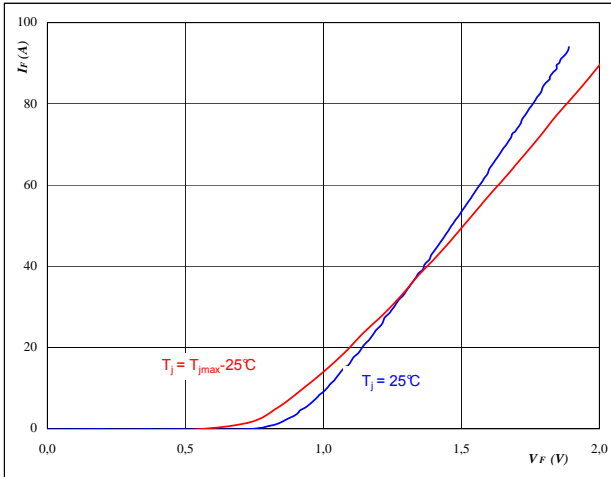

At
 $t_p = 250 \mu s$

Figure 2 Rectifier diode

Diode transient thermal impedance as a function of pulse width

$$Z_{thJH} = f(t_p)$$

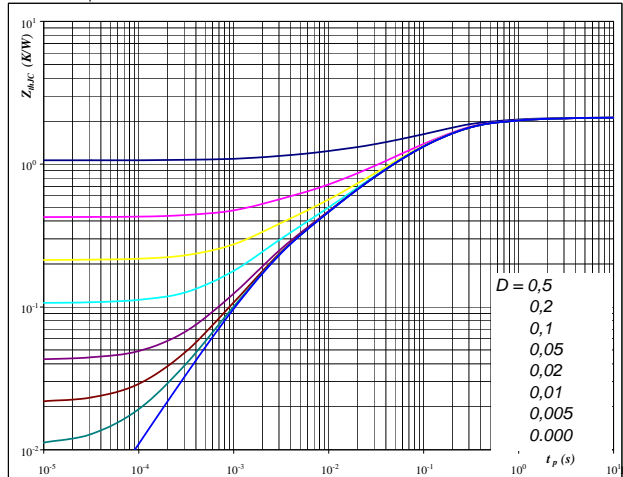

At
 $D = t_p / T$
 $R_{thJH} = 2,1 \text{ K/W}$

Figure 3 Rectifier diode

Power dissipation as a function of heatsink temperature

$$P_{tot} = f(T_h)$$

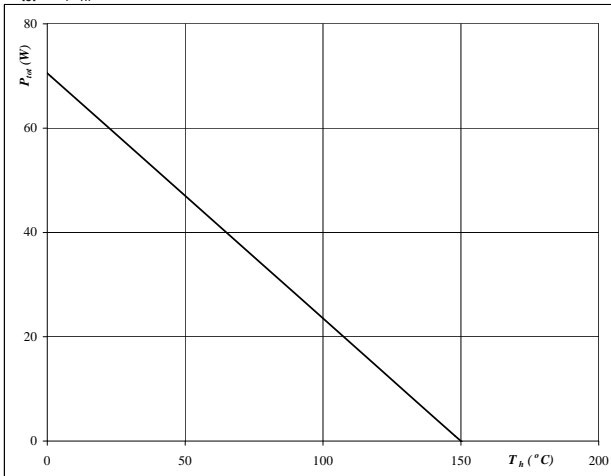

At
 $T_j = 150 \text{ °C}$

Figure 4 Rectifier diode

Forward current as a function of heatsink temperature

$$I_F = f(T_h)$$

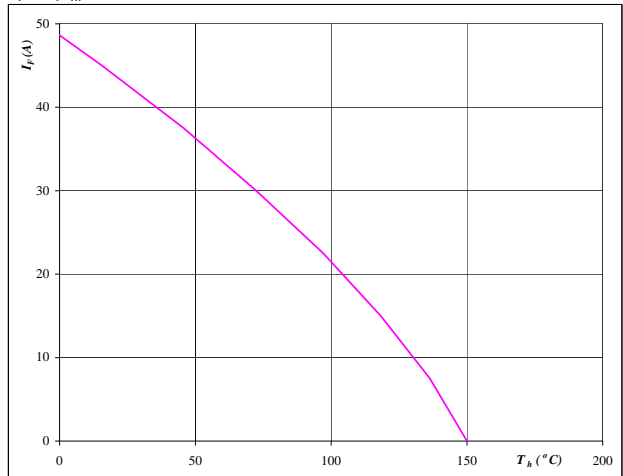

At
 $T_j = 150 \text{ °C}$

Thermistor

Figure 1 Thermistor

Typical NTC characteristic
as a function of temperature
 $R_T = f(T)$

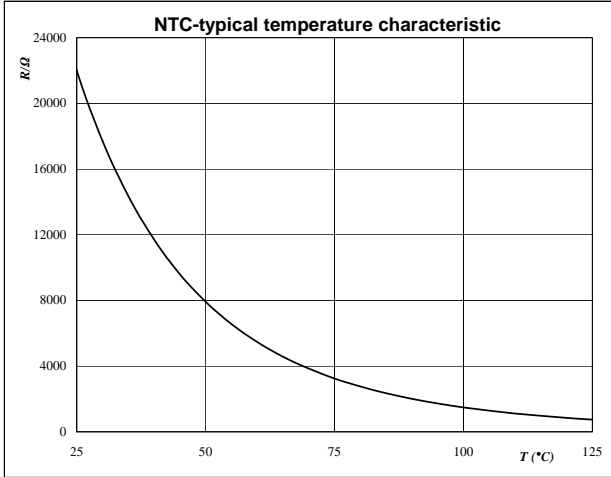

Figure 2 Thermistor

Typical NTC resistance values

$$R(T) = R_{25} \cdot e^{\left(B_{25/100} \left(\frac{1}{T} - \frac{1}{T_{25}} \right) \right)} \quad [\Omega]$$

T [°C]	R _{nom} [Ω]	R _{min} [Ω]	R _{max} [Ω]	ΔR/R [%]
-55	2089434,5	1506495,4	2672373,6	27,9
0	71804,2	59724,4	83884	16,8
10	43780,4	37094,4	50466,5	15,3
20	27484,6	23684,6	31284,7	13,8
25	22000	19109,3	24890,7	13,1
30	17723,3	15512,2	19934,4	12,5
60	5467,9	4980,6	5955,1	8,9
70	3848,6	3546	4151,1	7,9
80	2757,7	2568,2	2947,1	6,9
90	2008,9	1889,7	2128,2	5,9
100	1486,1	1411,8	1560,4	5
150	400,2	364,8	435,7	8,8

Switching Definitions Output Inverter

General conditions	
T_j	= 125 °C
R_{gon}	= 16 Ω
R_{goff}	= 8 Ω

Figure 1 Output inverter IGBT

Turn-off Switching Waveforms & definition of t_{doff} , t_{Eoff}
 (t_{Eoff} = integrating time for E_{off})

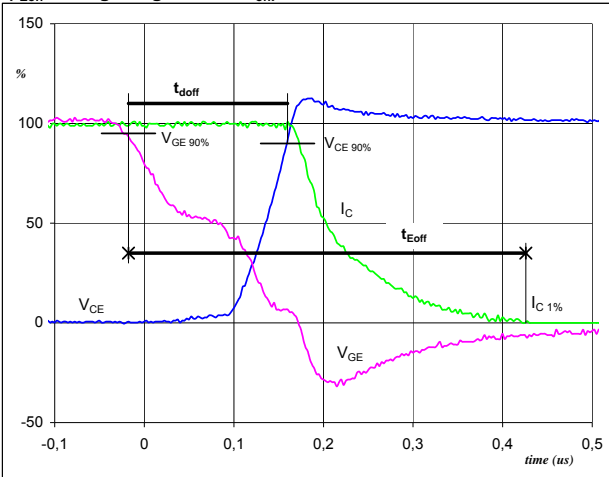

$V_{GE}(0\%) =$	0	V
$V_{GE}(100\%) =$	15	V
$V_C(100\%) =$	300	V
$I_C(100\%) =$	30	A
$t_{doff} =$	0,17	μs
$t_{Eoff} =$	0,44	μs

Figure 2 Output inverter IGBT

Turn-on Switching Waveforms & definition of t_{don} , t_{Eon}
 (t_{Eon} = integrating time for E_{on})

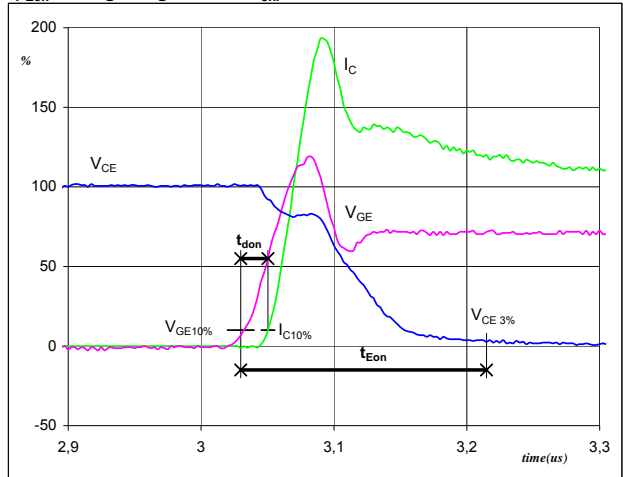

$V_{GE}(0\%) =$	0	V
$V_{GE}(100\%) =$	15	V
$V_C(100\%) =$	300	V
$I_C(100\%) =$	30	A
$t_{don} =$	0,02	μs
$t_{Eon} =$	0,18	μs

Figure 3 Output inverter IGBT

Turn-off Switching Waveforms & definition of t_f

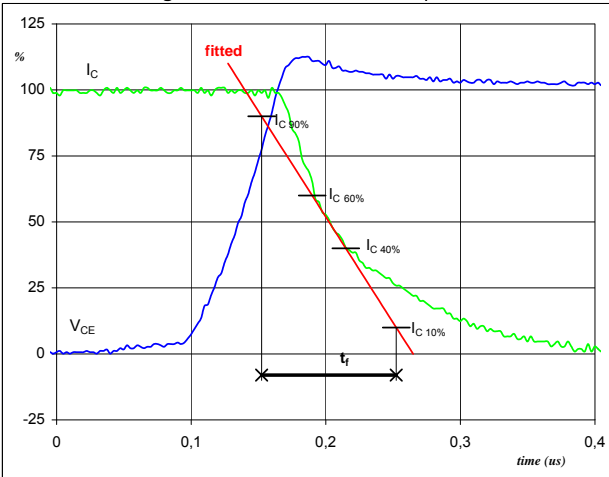

$V_C(100\%) =$	300	V
$I_C(100\%) =$	30	A
$t_f =$	0,10	μs

Figure 4 Output inverter IGBT

Turn-on Switching Waveforms & definition of t_r

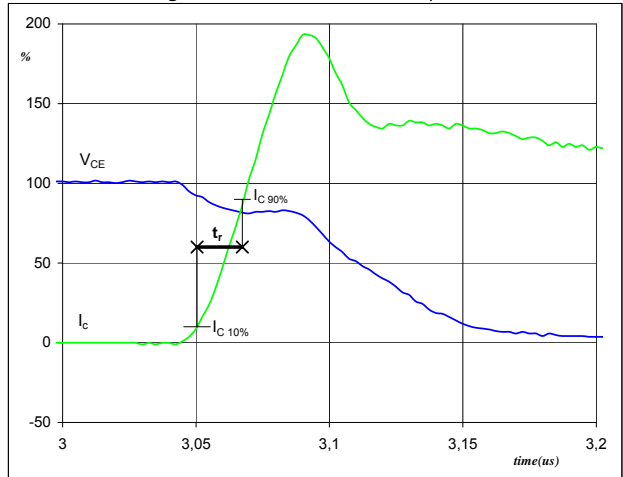

$V_C(100\%) =$	300	V
$I_C(100\%) =$	30	A
$t_r =$	0,02	μs

Switching Definitions Output Inverter

Figure 5 Output inverter IGBT

Turn-off Switching Waveforms & definition of t_{Eoff}

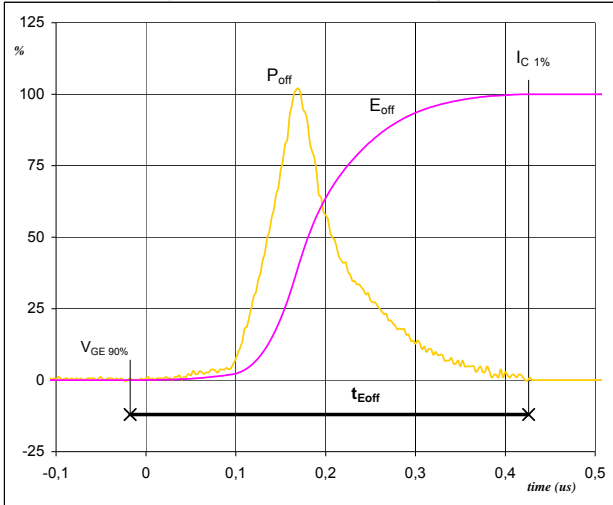

$P_{off}(100\%) = 8,98 \text{ kW}$
 $E_{off}(100\%) = 0,90 \text{ mJ}$
 $t_{Eoff} = 0,44 \text{ }\mu\text{s}$

Figure 6 Output inverter IGBT

Turn-on Switching Waveforms & definition of t_{Eon}

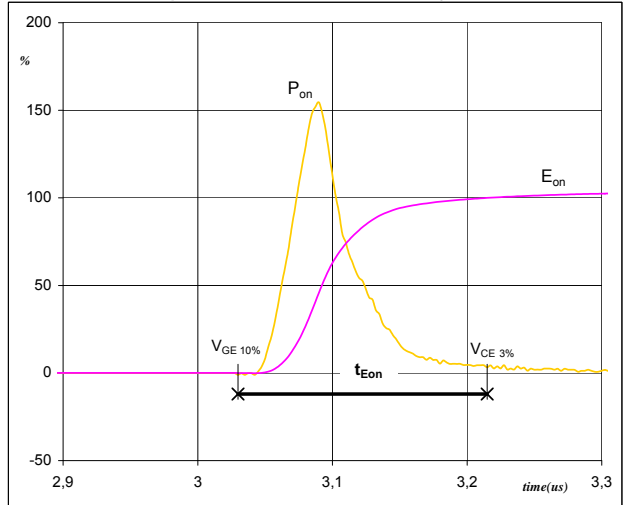

$P_{on}(100\%) = 8,98 \text{ kW}$
 $E_{on}(100\%) = 0,71 \text{ mJ}$
 $t_{Eon} = 0,18 \text{ }\mu\text{s}$

Figure 7 Output inverter FWD

Gate voltage vs Gate charge (measured)

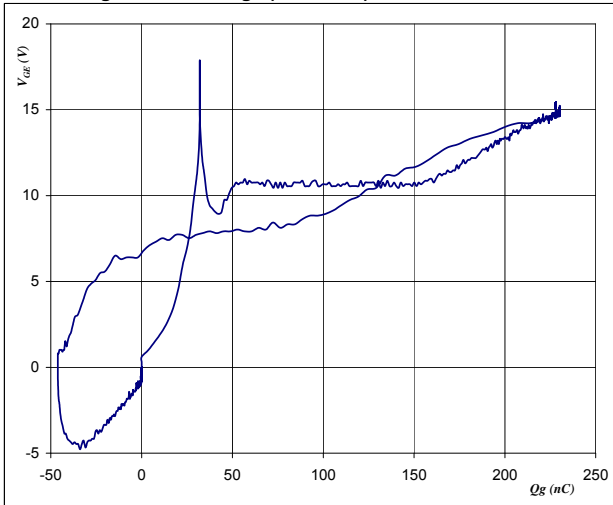

$V_{GEoff} = 0 \text{ V}$
 $V_{GEon} = 15 \text{ V}$
 $V_C(100\%) = 300 \text{ V}$
 $I_C(100\%) = 30 \text{ A}$
 $Q_g = 230,15 \text{ nC}$

Figure 8 Output inverter IGBT

Turn-off Switching Waveforms & definition of t_{rr}

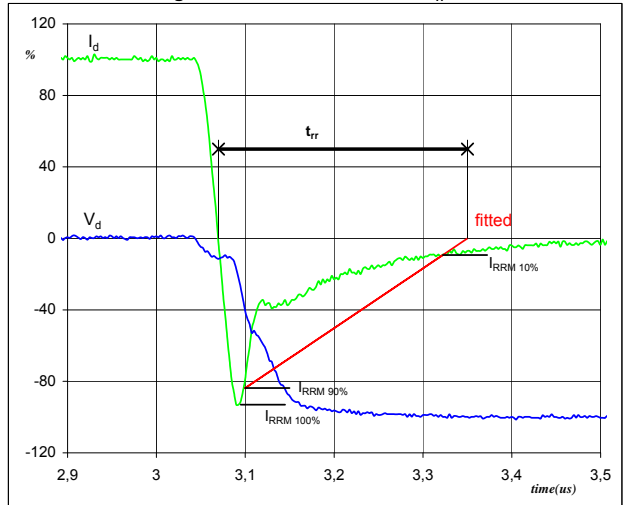

$V_d(100\%) = 300 \text{ V}$
 $I_d(100\%) = 30 \text{ A}$
 $I_{RRM}(100\%) = 28 \text{ A}$
 $t_{rr} = 0,26 \text{ }\mu\text{s}$

Switching Definitions Output Inverter

Figure 9 Output inverter FWD

Turn-on Switching Waveforms & definition of t_{Qrr}
 (t_{Qrr} = integrating time for Q_{rr})

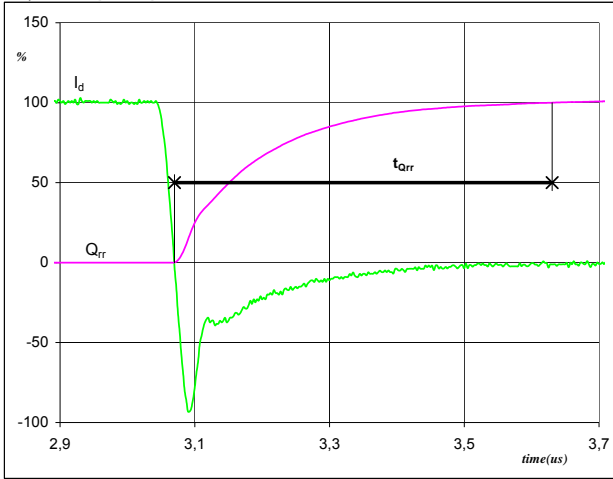

I_d (100%) =	30	A
Q_{rr} (100%) =	2,45	μC
t_{Qrr} =	0,56	μs

Figure 10 Output inverter FWD

Turn-on Switching Waveforms & definition of t_{Erec}
 (t_{Erec} = integrating time for E_{rec})

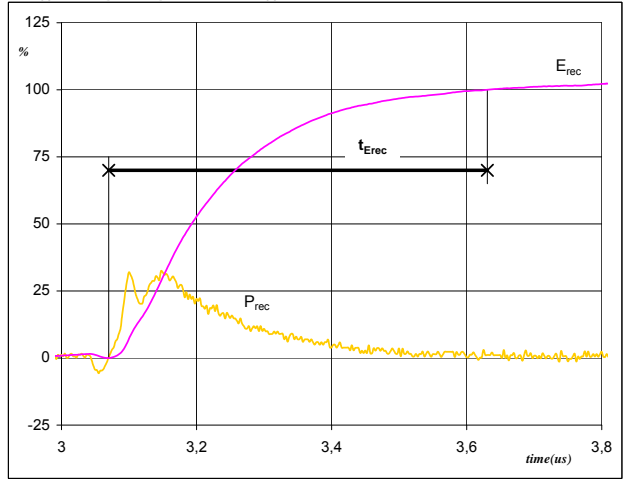

P_{rec} (100%) =	8,98	kW
E_{rec} (100%) =	0,51	mJ
t_{Erec} =	0,56	μs

Ordering Code and Marking - Outline - Pinout

Ordering Code & Marking

Version	Ordering Code	in DataMatrix as	in packaging barcode as
without thermal paste 12mm 2clips housing	V23990-P546-A28-PM	P546-A28	P546-A28
without thermal paste 17mm 2clips housing	V23990-P546-A29-PM	P546-A29	P546-A29
without thermal paste 17mm 2clips housing	V23990-P546-C28-PM	P546-C28	P546-C28
without thermal paste 12mm 2clips housing	V23990-P546-C29-PM	P546-C29	P546-C29

Pin table		
Pin	X	Y
1	25.5	2.7
2	25.5	0
3	22.8	0
4	20.1	0
5	16.2	0
6	13.5	0
7	10.8	0
8	8.1	0
9	5.4	0
10	2.7	0
11	0	0
12	0	19.8
13	0	22.5
14	7.5	19.8
15	7.5	22.5
16	15	19.8
17	15	22.5
18	22.8	22.5
19	25.5	22.5
20	33.5	22.5
21	33.5	15
22	33.5	7.5
23	33.5	0

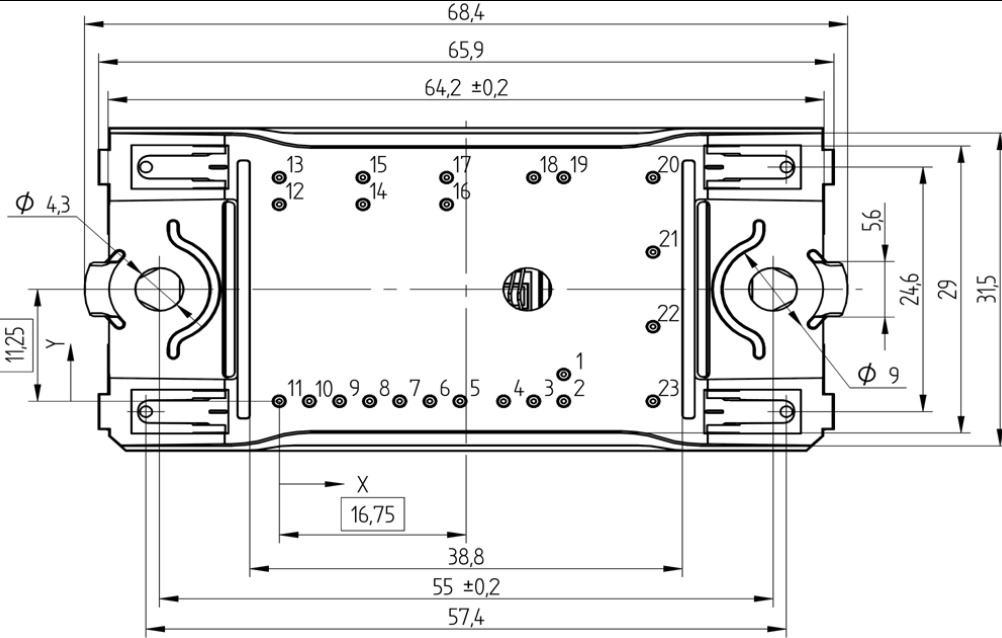

Pinout

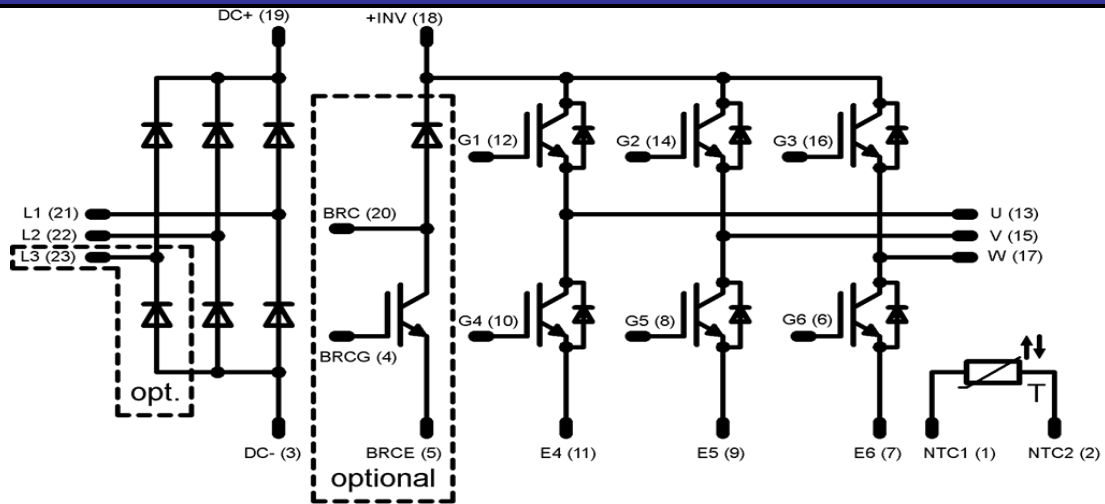

DISCLAIMER

The information given in this datasheet describes the type of component and does not represent assured characteristics. For tested values please contact Vincotech. Vincotech reserves the right to make changes without further notice to any products herein to improve reliability, function or design. Vincotech does not assume any liability arising out of the application or use of any product or circuit described herein; neither does it convey any license under its patent rights, nor the rights of others.

LIFE SUPPORT POLICY

Vincotech products are not authorised for use as critical components in life support devices or systems without the express written approval of Vincotech.

As used herein:

1. Life support devices or systems are devices or systems which, (a) are intended for surgical implant into the body, or (b) support or sustain life, or (c) whose failure to perform when properly used in accordance with instructions for use provided in labelling can be reasonably expected to result in significant injury to the user.
2. A critical component is any component of a life support device or system whose failure to perform can be reasonably expected to cause the failure of the life support device or system, or to affect its safety or effectiveness.