

SAW FILTER FOR GSM900/GSM1800 (Rx)

Murata part number : SAWEP942MCN0F00 (fc=942.5MHz)

Package Dimensions

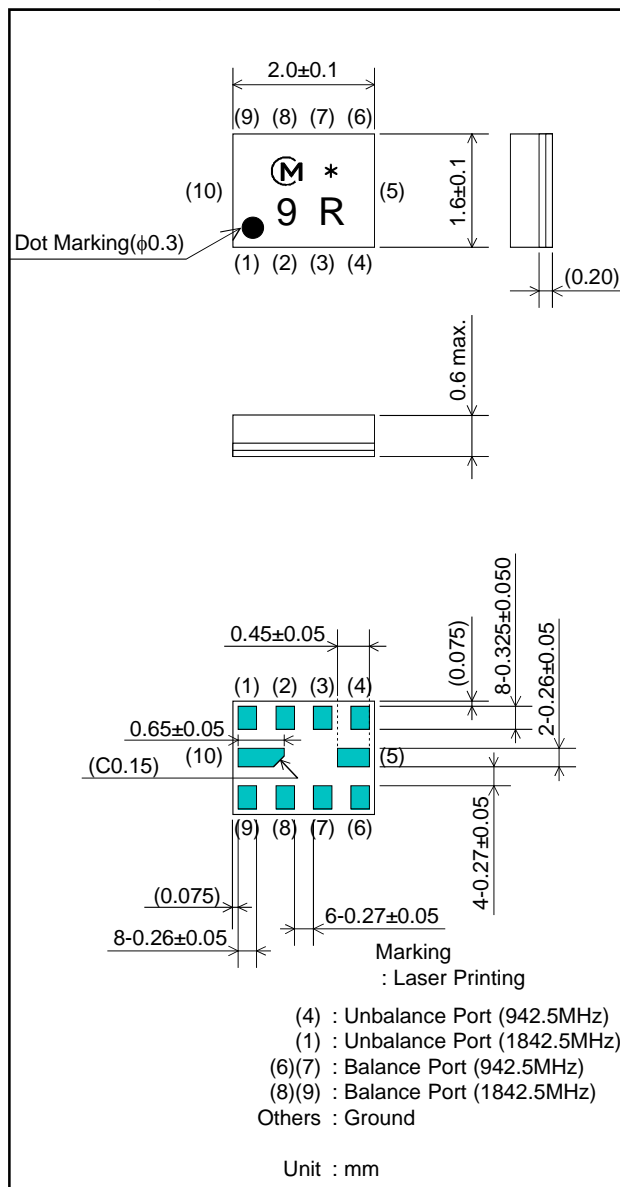

Specification

Item	Specification			
	-30 to 85°C	-10 to 80°C	25±2°C	typ.
Nominal Center Frequency(fc)	942.5 MHz			
Insertion Loss (925 to 960MHz)	2.7 dB max.	2.3 dB max.	2.1 dB max.	1.9 dB
Absolute Attenuation				
1) 100 to 860 MHz	50 dB min.	50 dB min.	50 dB min.	63 dB
2) 860 to 880 MHz	45 dB min.	45 dB min.	45 dB min.	66 dB
3) 880 to 905 MHz	30 dB min.	30 dB min.	30 dB min.	41 dB
4) 905 to 915 MHz	20 dB min.	20 dB min.	22 dB min.	31 dB
5) 980 to 1050 MHz	23 dB min.	23 dB min.	23 dB min.	29 dB
6) 1050 to 3000 MHz	45 dB min.	45 dB min.	45 dB min.	51 dB
7) 3000 to 6000 MHz	35 dB min.	35 dB min.	35 dB min.	43 dB
Ripple Deviation (925 to 960MHz)	1.7 dB max.	1.3 dB max.	1.1 dB max.	0.6 dB
VSWR (925 to 960MHz)	2.1 max.	2.1 max.	2.0 max.	1.7
Amplitude Balance (925 to 960MHz)	±1.0dB max.	±0.8dB max.	±0.6dB max.	±0.2dB
Phase Balance (925 to 960MHz)	180±10deg. max.	180±7deg. max.	180±5deg. max.	180±1.2deg
Unbalance Port Matching Impedance (nominal)	50Ω			
Balance Port Matching Impedance (nominal)	150Ω//82nH			
Input Signal Level	31.6mW (+15dBm), 2000 hours			

SAW FILTER FOR GSM900/GSM1800 (Rx)

Murata part number : SAWEP942MCN0F00 (fc=942.5MHz)

Frequency Performance

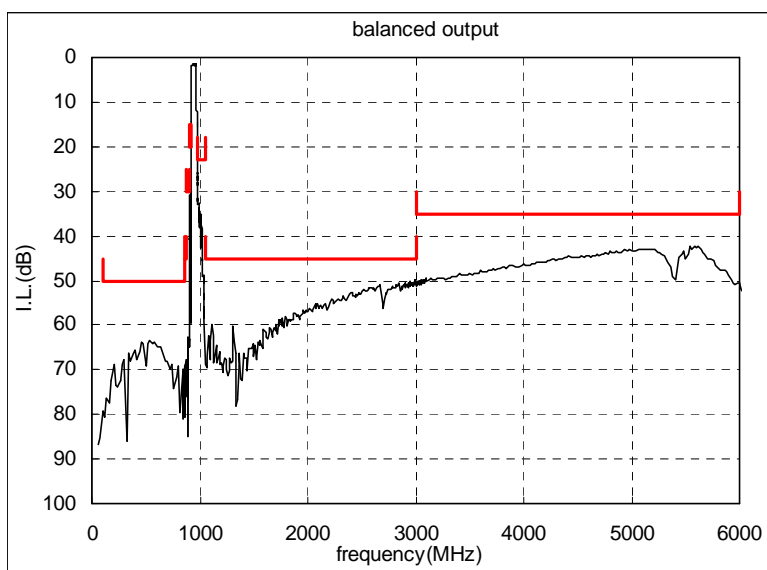
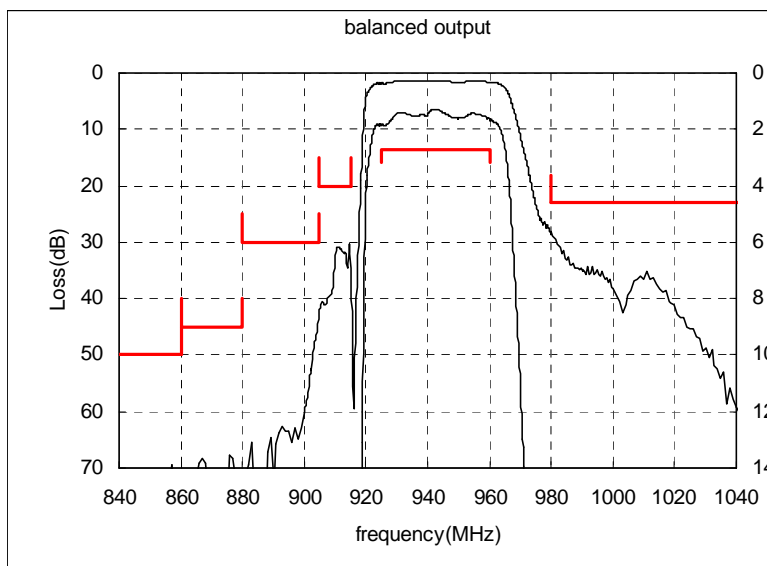

Amplitude balance

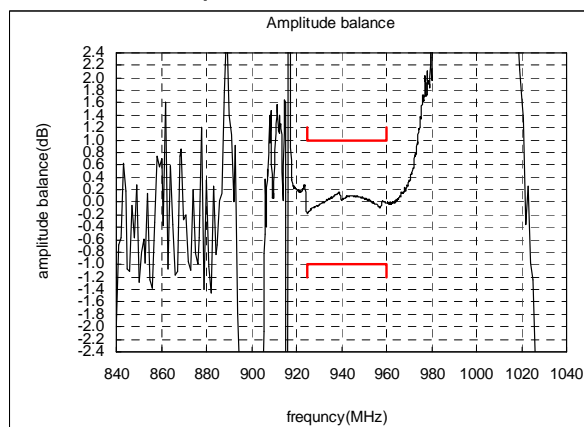

Phase balance

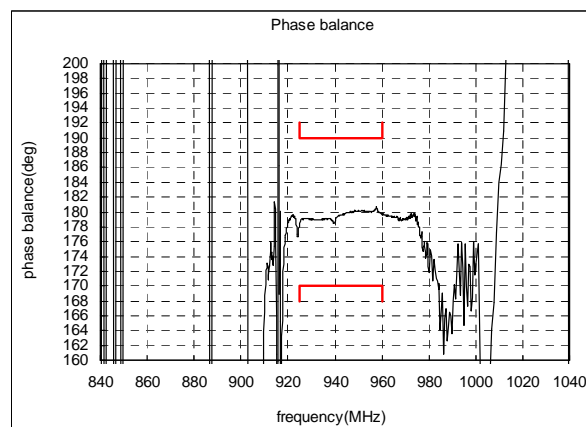

SAW FILTER FOR GSM900/GSM1800 (Rx)

Murata part number : SAWEP942MCN0F00 (fc=1842.5MHz)

Package Dimensions

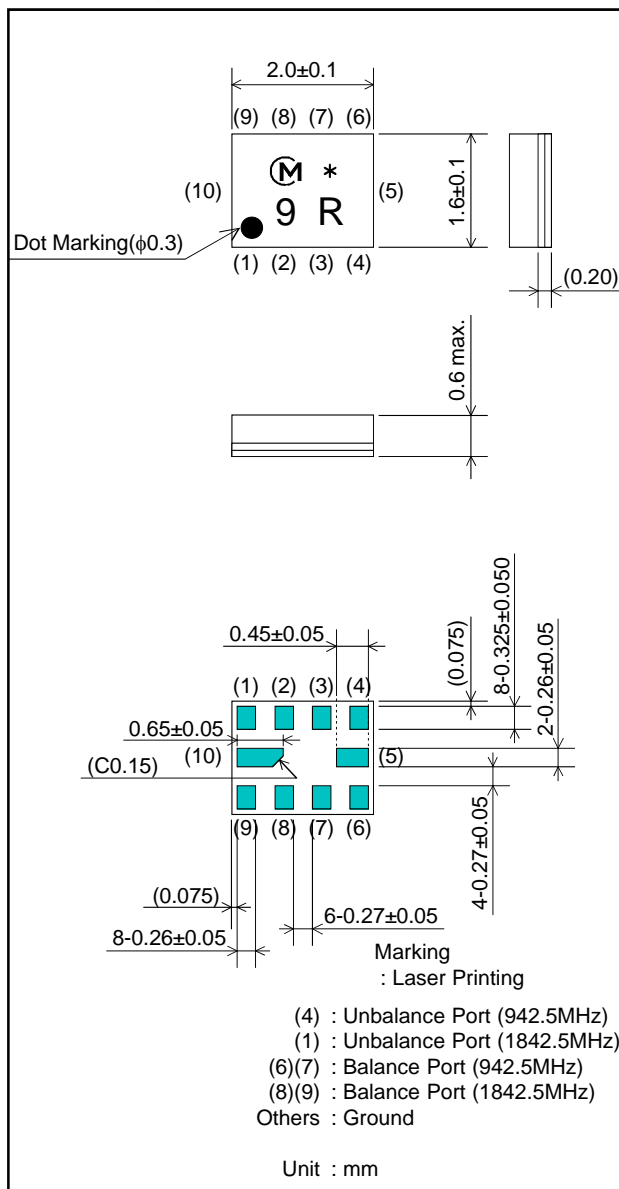

Specification

Item	Specification			
	-30 to 85°C	-10 to 80°C	25±2°C	typ.
Nominal Center Frequency(fc)	1842.5 MHz			
Insertion Loss (1805 to 1880MHz)	2.5 dB max.	2.2 dB max.	1.8 dB max.	1.6 dB
Absolute Attenuation				
1) 100 to 1300 MHz	35 dB min.	35 dB min.	35 dB min.	49 dB
2) 1300 to 1705 MHz	20 dB min.	20 dB min.	20 dB min.	32 dB
3) 1705 to 1785 MHz	10 dB min.	11 dB min.	13 dB min.	16 dB
4) 1920 to 1980 MHz	12 dB min.	13 dB min.	15 dB min.	18 dB
5) 1980 to 3000 MHz	20 dB min.	20 dB min.	20 dB min.	23 dB
6) 3000 to 4000 MHz	40 dB min.	40 dB min.	40 dB min.	45 dB
7) 4000 to 5000 MHz	35 dB min.	35 dB min.	35 dB min.	41 dB
8) 5000 to 6000 MHz	30 dB min.	30 dB min.	30 dB min.	34 dB
Ripple Deviation (1805 to 1880MHz)	1.5 dB max.	1.2 dB max.	0.8 dB max.	0.4 dB
VSWR (1805 to 1880MHz)	2.3 max.	2.2 max.	2.1 max.	1.7
Amplitude Balance (1805 to 1880MHz)	±1.5dB max.	±1.5dB max.	±1.4dB max.	±0.9dB
Phase Balance (1805 to 1880MHz)	180±12deg. max.	180±12deg. max.	180±10deg. max.	180±5deg.
Unbalance Port Matching Impedance (nominal)	50Ω			
Balance Port Matching Impedance (nominal)	150Ω//15nH			
Input Signal Level	20mW (+13dBm), 2000 hours			

SAW FILTER FOR GSM900/GSM1800 (Rx)

Murata part number : SAWEP942MCN0F00 (fc=1842.5MHz)

Frequency Performance

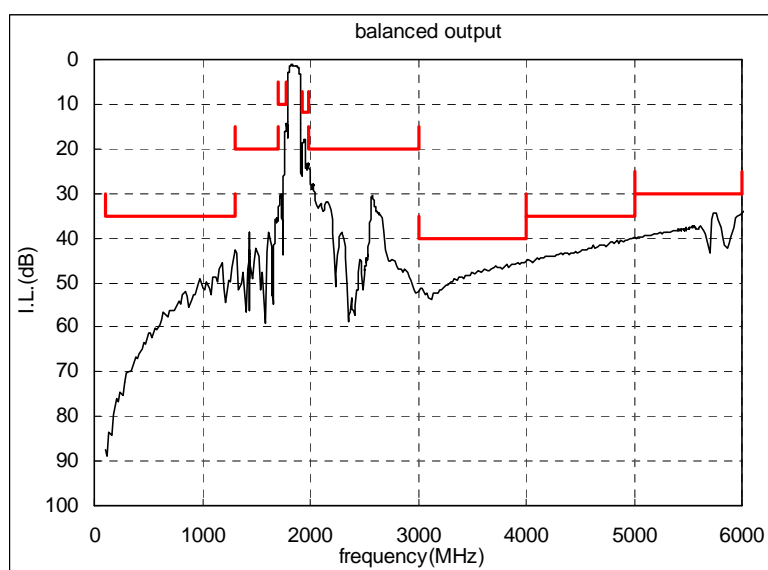
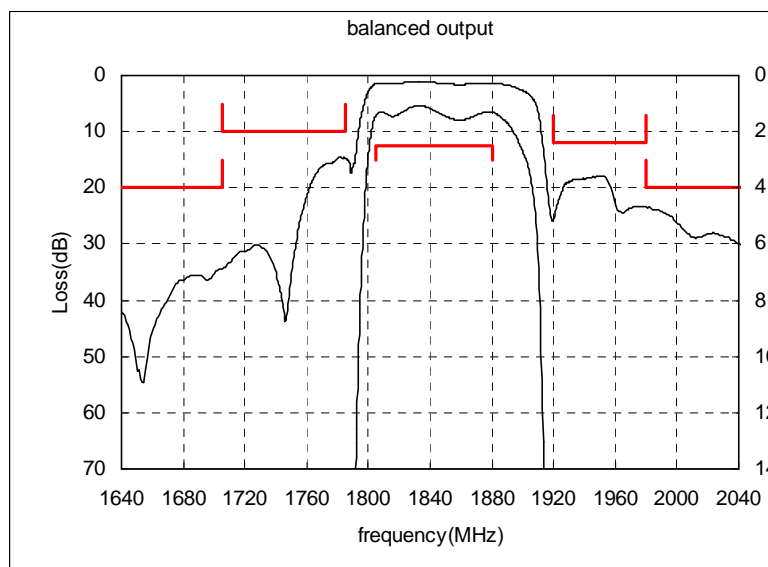

Amplitude balance

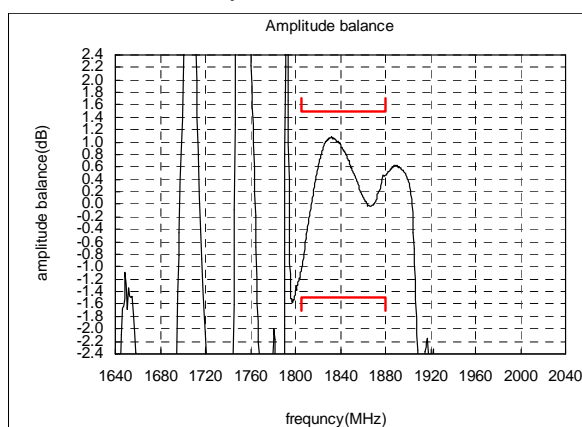

Phase balance

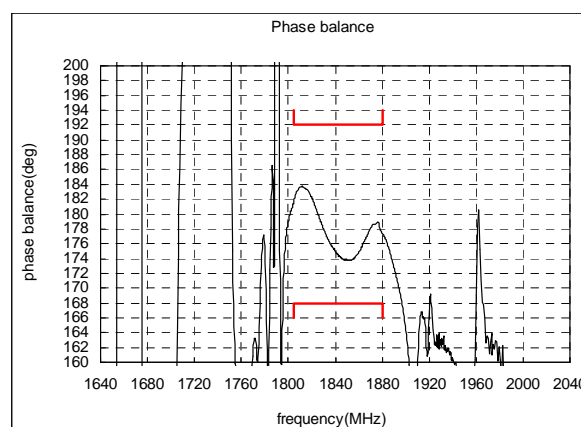

SAW FILTER FOR GSM900/GSM1800 (Rx)

Murata part number : SAWEP942MCN0F00

■ Dimensions of Carrier Tape

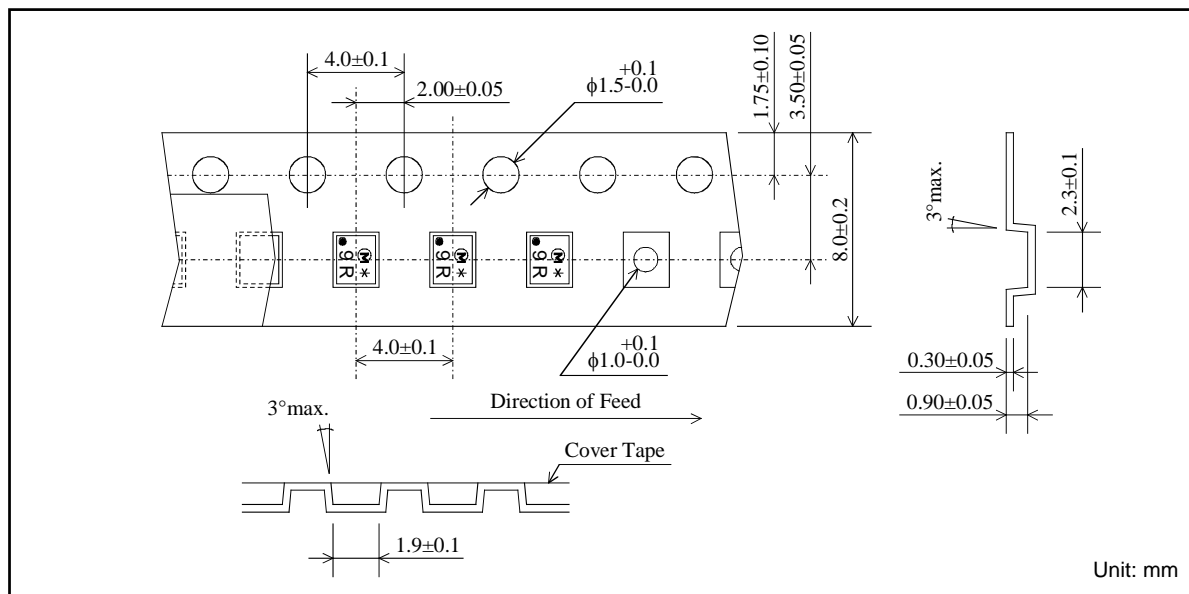

■ Dimensions of Tape

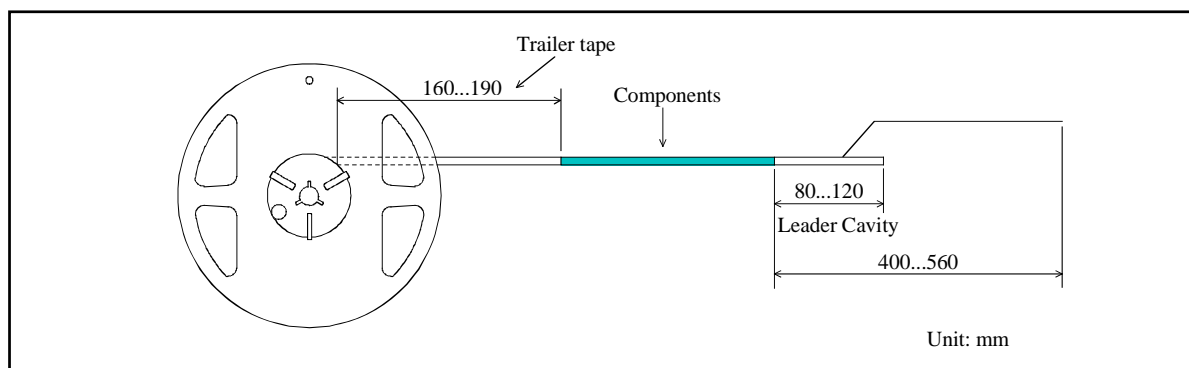

■ Dimensions of Reel

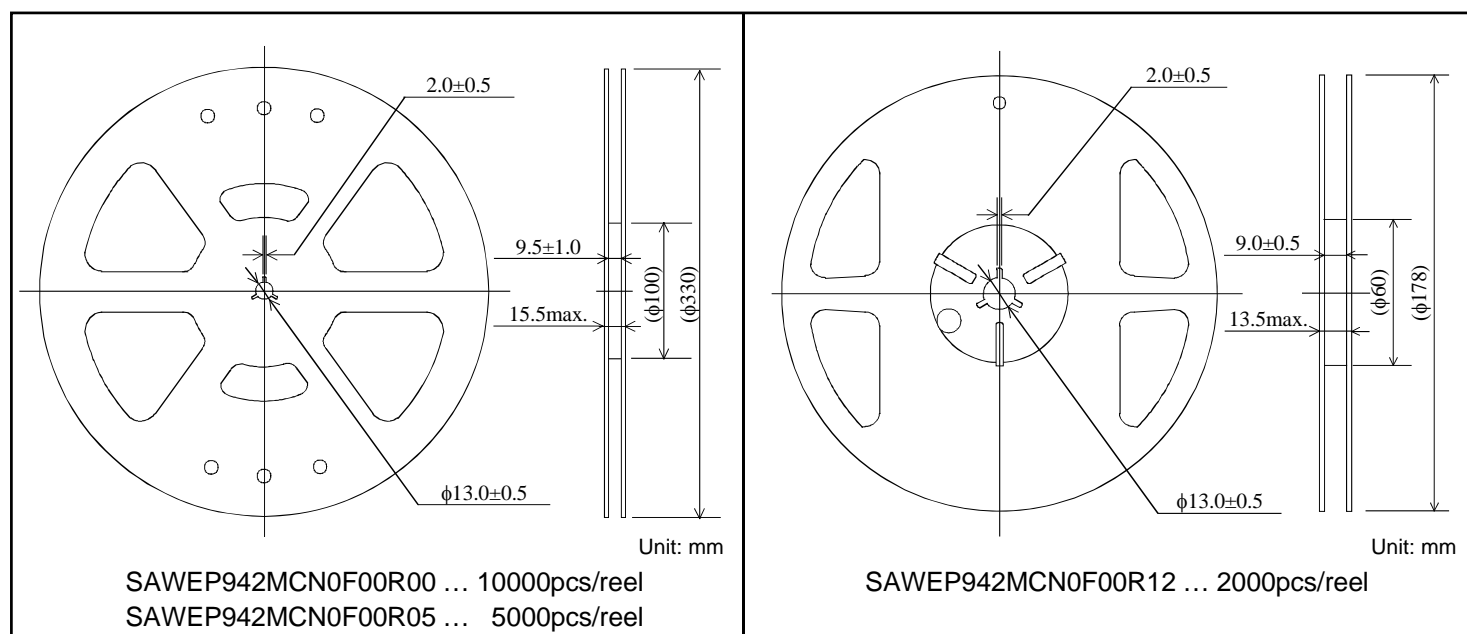

SAW FILTER FOR GSM900/GSM1800 (Rx)

Murata part number : SAWEP942MCN0F00

Recommended Land Pattern

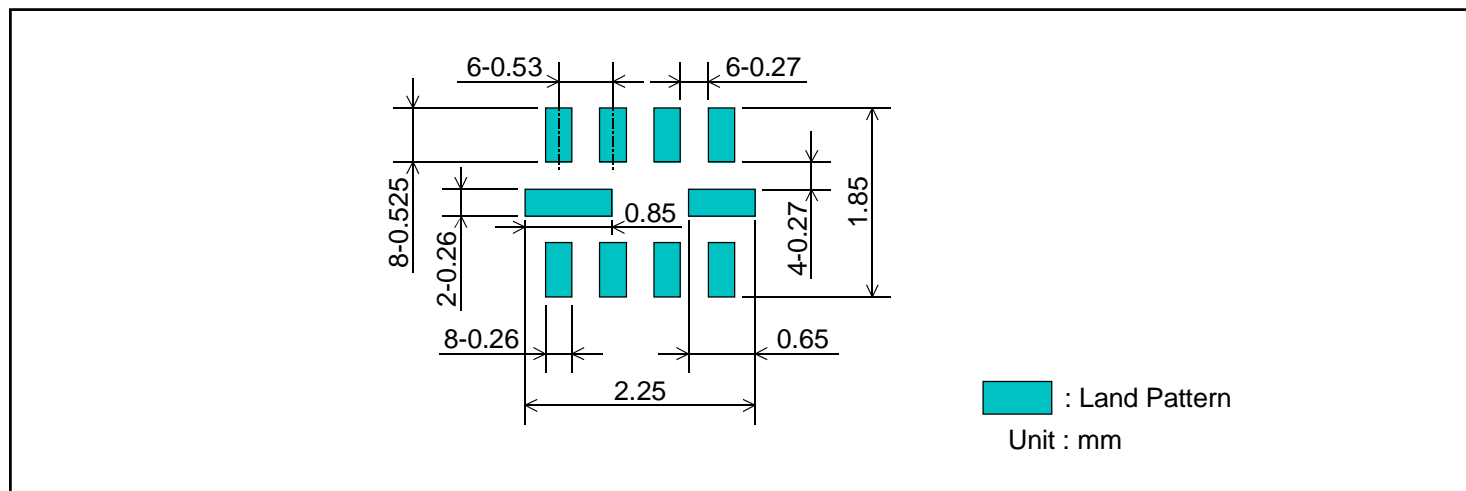

Test Circuit

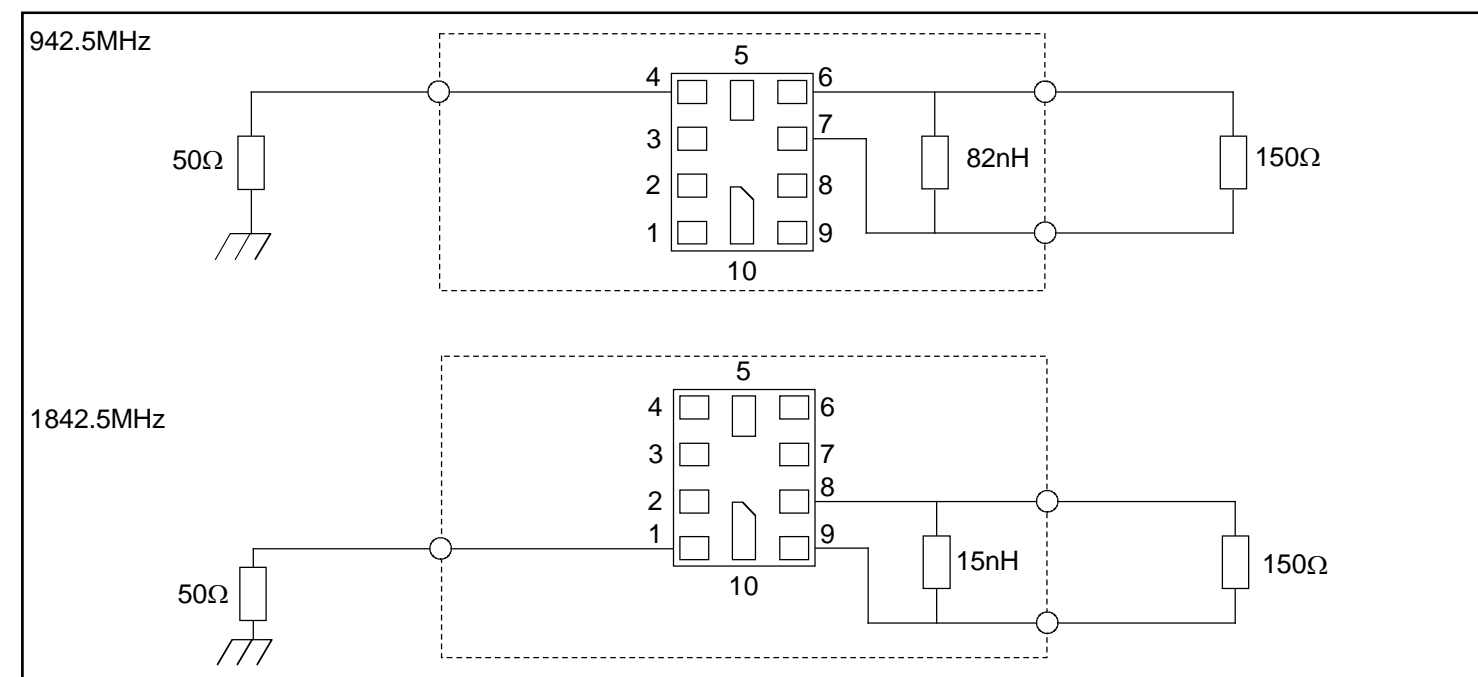

- This PDF Datasheet is downloaded from the website of Murata Manufacturing Co., Ltd. Therefore, it's specifications are subject to change or our products in it may be discontinued without advance notice. Please check with our sales representatives or product engineers before ordering.
- This PDF Datasheet has only typical specifications because there is no space for detailed specifications. Therefore, please approve our product specifications or transact the approval sheet for product specifications before ordering.