

SG15SC6M

60V 15A

特長

- 低 V_F
- 低ノイズ
- 高速スイッチング
- フルモールド

Feature

- Low V_F
- Low Noise
- High Recovery Speed
- Full Molded

■ 外観図 OUTLINE

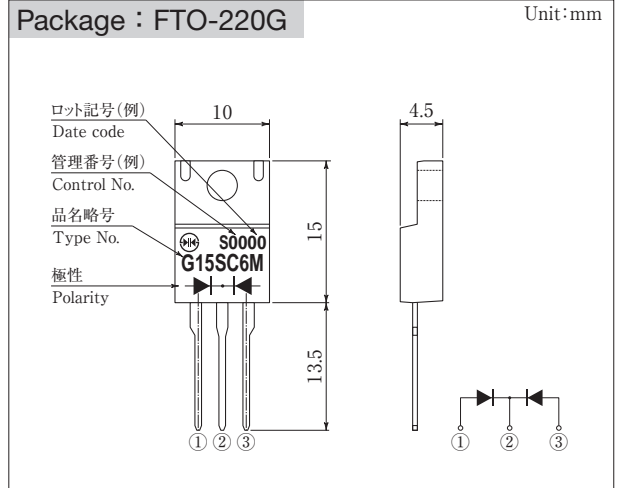

外形図については新電元Webサイトをご参照下さい。捺印表示については捺印仕様をご確認下さい。

For details of the outline dimensions, refer to our web site. As for the marking, refer to the specification "Marking, Terminal Connection".

■ 定格表 RATINGS

● 絶対最大定格 Absolute Maximum Ratings (指定のない場合 $T_c = 25^\circ\text{C}$)

項目 Item	記号 Symbol	条件 Conditions	規格値 Ratings	単位 Unit
保存温度 Storage Temperature	T_{stg}		- 55 ~ 150	$^\circ\text{C}$
接合部温度 Operation Junction Temperature	T_j		150	$^\circ\text{C}$
せん頭逆電圧 Maximum Reverse Voltage	V_{RM}		60	V
繰り返しせん頭サージ逆電圧 Repetitive Peak Surge Reverse Voltage	V_{RRSM}	パルス幅0.5ms, duty 1/40 Pulse width 0.5ms, duty 1/40	65	V
出力電流 Average Rectified Forward Current	I_o	50Hz 正弦波, 抵抗負荷, $T_c = 113^\circ\text{C}$ 50Hz sine wave, Resistance load, $T_c = 113^\circ\text{C}$	15	A
せん頭サージ順電流 Peak Surge Forward Current	I_{FSM}	50Hz 正弦波, 非繰り返し1サイクルせん頭値, $T_j = 25^\circ\text{C}$ 50Hz sine wave, Non-repetitive 1 cycle peak value, $T_j = 25^\circ\text{C}$	180	A
絶縁耐圧 Dielectric Strength	V_{dis}	一括端子・ケース裏面間, AC 1分間印加 Terminals to case, AC 1 minute	1.5	kV
締め付けトルク Mounting Torque	TOR	(推奨値: $0.3\text{N}\cdot\text{m}$) (Recommended torque: $0.3\text{N}\cdot\text{m}$)	0.5	$\text{N}\cdot\text{m}$

● 電氣的・熱的特性 Electrical Characteristics (指定のない場合 $T_c = 25^\circ\text{C}$)

順電圧 Forward Voltage	V_F	$I_F = 7.5\text{A}$, パルス測定, 1素子当りの規格値 Pulse measurement, Per diode	MAX 0.61 TYP 0.56	V
逆電流 Reverse Current	I_R	$V_R = 60\text{V}$, パルス測定, 1素子当りの規格値 Pulse measurement, Per diode	MAX 0.6	mA
接合容量 Junction Capacitance	C_j	$f = 1\text{MHz}$, $V_R = 10\text{V}$, 1素子当りの規格値 Per diode	TYP 185	pF
熱抵抗 Thermal Resistance	θ_{jc}	接合部・ケース間 Junction to case	MAX 3.0	$^\circ\text{C}/\text{W}$

■特性図 CHARACTERISTIC DIAGRAMS

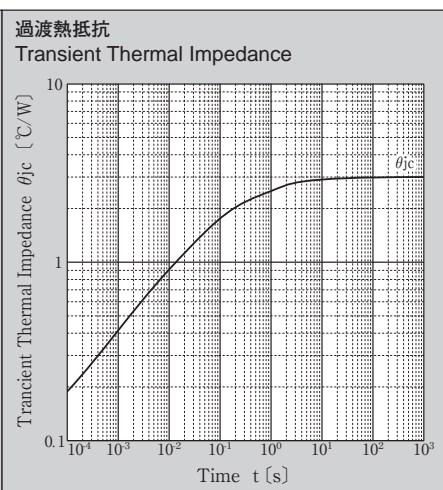
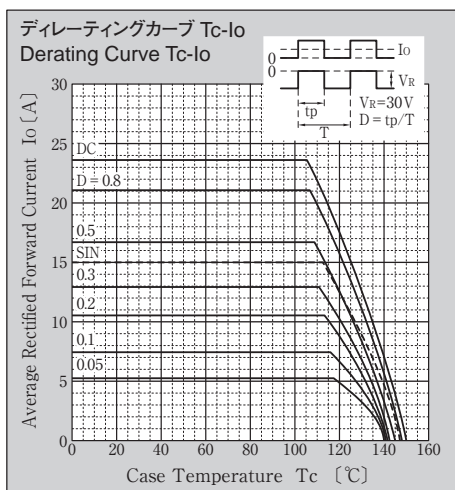
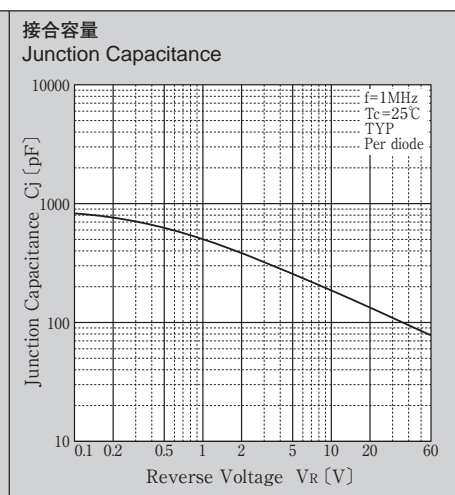
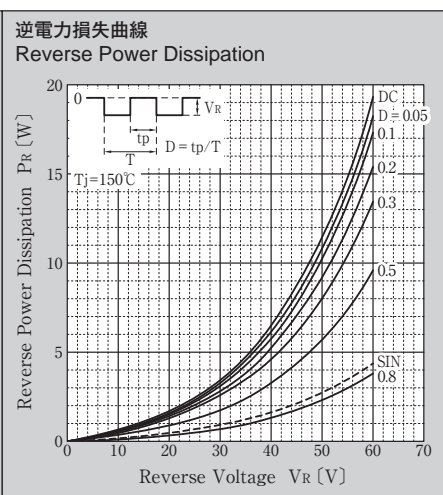
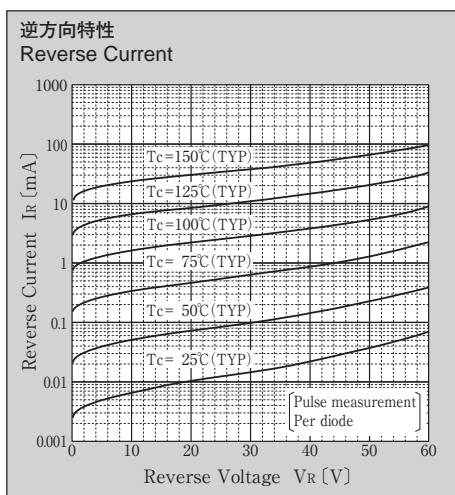
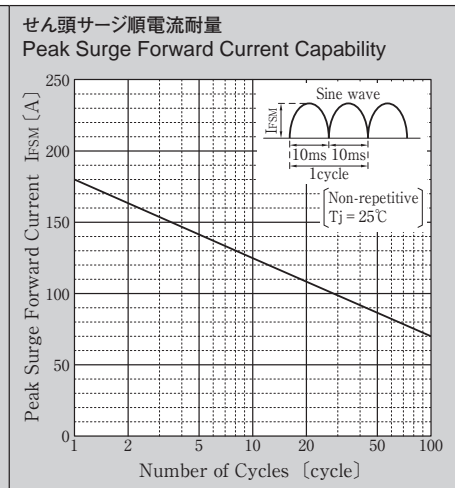
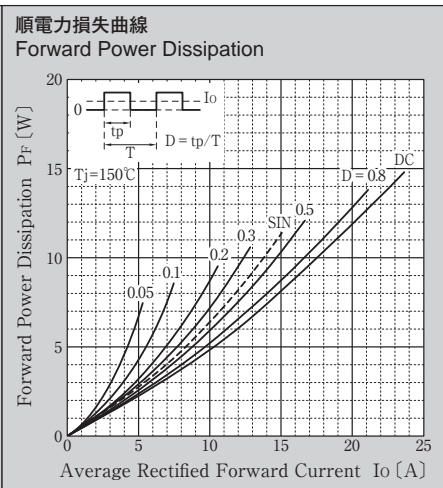
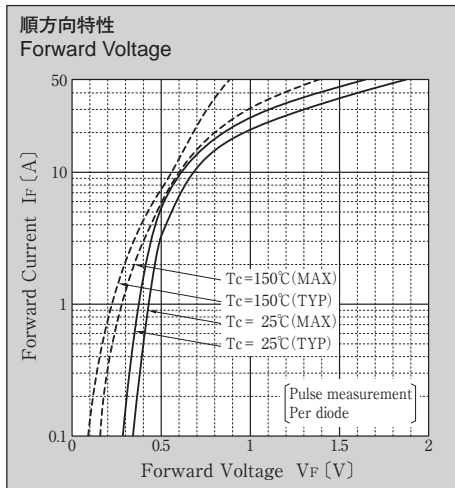

* Sine waveは50Hzで測定しています。
* 50Hz sine wave is used for measurements.