

TC7SZ126F, TC7SZ126FU

BUS BUFFER, 3-STATE OUTPUT

FEATURES

- High Output Drive : ± 24 mA (Typ.)
@ $V_{CC} = 3$ V
- Super High Speed Operation : t_{pD} 2.6 ns (Typ.)
@ $V_{CC} = 5$ V, 50 pF
- Operation Voltage Range : $V_{CC(opr)} = 1.8\sim 5.5$ V
- Supply Voltage Data Retention : $V_{CC} = 1.5\sim 5.5$ V
- 5 V Tolerant Function
- Matches the Performance of TC74LCX Series when Operated at 3.3 V V_{CC}

MAXIMUM RATINGS (Ta = 25°C)

CHARACTERISTIC	SYMBOL	RATING	UNIT
Supply Voltage Range	V_{CC}	-0.5~6	V
DC Input Voltage	V_{IN}	-0.5~6	V
DC Output Voltage	V_{OUT}	-0.5~6	V
Input Diode Current	I_{IK}	± 20	mA
Output Diode Current	I_{OK}	± 20	mA
DC Output Current	I_{OUT}	± 50	mA
DC V_{CC} /Ground Current	I_{CC}	± 50	mA
Power Dissipation	P_D	200	mW
Storage Temperature	T_{stg}	-65~150	°C
Lead Temperature (10 s)	T_L	260	°C

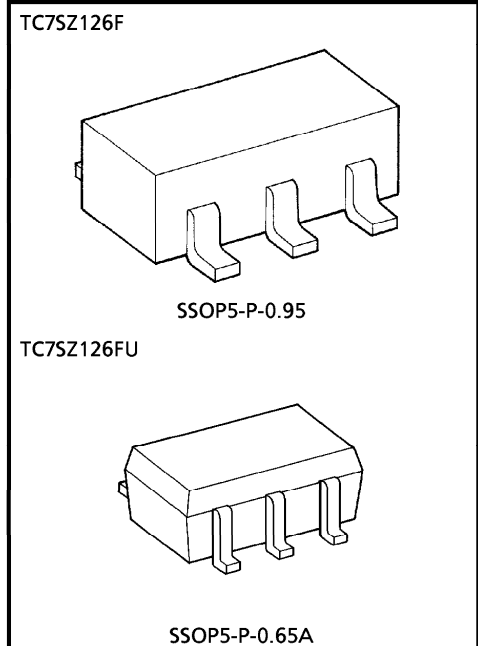

Weight
 SSOP5-P-0.95 : 0.016 g (Typ.)
 SSOP5-P-0.65A : 0.006 g (Typ.)

TC7SZ126F, TC7SZ126FU

DC ELECTRICAL CHARACTERISTICS

CHARACTERISTIC	SYMBOL	TEST CONDITION	V _{CC} (V)	Ta = 25°C			Ta = -40~85°C		UNIT		
				MIN.	TYP.	MAX.	MIN.	MAX.			
High-Level Input Voltage	V _{IH}		1.8	0.88 × V _{CC}	—	—	0.88 × V _{CC}	—	V		
			2.3 – 5.5	0.75 × V _{CC}	—	—	0.75 × V _{CC}	—			
Low-Level Input Voltage	V _{IL}		1.8	—	—	0.12 × V _{CC}	—	0.12 × V _{CC}	V		
			2.3 – 5.5	—	—	0.25 × V _{CC}	—	0.25 × V _{CC}			
High-Level Output Voltage	V _{OH}	V _{IN} = V _{IH}	I _{OH} = -100 μA	1.8	1.7	1.8	—	1.7	—	V	
				2.3	2.2	2.3	—	2.2	—		
				3.0	2.9	3.0	—	2.9	—		
				4.5	4.4	4.5	—	4.4	—		
				I _{OH} = -8 mA	2.3	1.9	2.15	—	1.9		—
					3.0	2.4	2.8	—	2.4		—
					3.0	2.3	2.68	—	2.3		—
I _{OH} = -32 mA	4.5	3.8	4.2	—	3.8	—					
Low-Level Output Voltage	V _{OL}	V _{IN} = V _{IL}	I _{OL} = 100 μA	1.8	—	0	0.1	—	0.1	V	
				2.3	—	0	0.1	—	0.1		
				3.0	—	0	0.1	—	0.1		
				4.5	—	0	0.1	—	0.1		
				I _{OL} = 8 mA	2.3	—	0.1	0.3	—		0.3
					3.0	—	0.15	0.4	—		0.4
					3.0	—	0.22	0.55	—		0.55
I _{OL} = 32 mA	4.5	—	0.22	0.55	—	0.55					
Input Leakage Current	I _{IN}	V _{IN} = 5.5 V or GND	0 – 5.5	—	—	± 1	—	± 10	μA		
Power Off Leakage Current	I _{OFF}	V _{IN} or V _{OUT} = 5.5 V	0.0	—	—	1	—	10	μA		
Quiescent Supply Current	I _{CC}	V _{IN} = V _{CC} or GND	5.5	—	—	2	—	20	μA		

TC7SZ126F, TC7SZ126FU

AC ELECTRICAL CHARACTERISTICS (Input $t_r = t_f = 3$ ns)

CHARACTERISTIC	SYMBOL	TEST CONDITION	Ta = 25°C			Ta = -40~85°C		UNIT	
			V _{CC} (V)	MIN.	TYP.	MAX.	MIN.		MAX.
Propagation Delay Time	t _{PLH} t _{PHL}	C _L = 15 pF, R _L = 1 MΩ (Figure 1)	1.8	2.0	5.3	11.0	2.0	11.5	ns
			2.5 ± 0.2	0.8	3.4	7.5	0.8	8.0	
			3.3 ± 0.3	0.5	2.5	5.2	0.5	5.5	
			5.0 ± 0.5	0.5	2.1	4.5	0.5	4.8	
		C _L = 50 pF, R _L = 500 Ω (Figure 1)	3.3 ± 0.3	1.5	3.2	5.7	1.5	6.0	
			5.0 ± 0.5	0.8	2.6	5.0	0.8	5.3	
Output Enable Time	t _{PZL} t _{PZH}	C _L = 50 pF, R _L = 500 Ω (Figure 1)	1.8	2.0	6.1	11.5	2.0	12.0	ns
			2.5 ± 0.2	1.5	3.8	8.0	1.5	8.5	
			3.3 ± 0.3	1.5	3.2	5.7	1.5	6.0	
			5.0 ± 0.5	0.8	2.3	5.0	0.8	5.3	
Output Disable Time	t _{PLZ} t _{PHZ}	C _L = 50 pF, R _L = 500 Ω (Figure 1)	1.8	2.0	5.6	11.0	2.0	12.0	ns
			2.5 ± 0.2	1.0	4.0	8.0	1.0	8.5	
			3.3 ± 0.3	1.0	3.5	5.7	1.0	6.0	
			5.0 ± 0.5	0.5	2.5	4.7	0.5	5.0	
Input Capacitance	C _{IN}		0 - 5.5	—	4	—	—	pF	
Power Dissipation Capacitance	C _{PD}	(Note 1)	3.3	—	17	—	—	—	pF
			5.5	—	24	—	—	—	

(Note 1) C_{PD} is defined as the value of the internal equivalent capacitance which is calculated from the operating current consumption without load. Average operating current can be obtained by the equation.
 $I_{CC(opr)} = C_{PD} \cdot V_{CC} \cdot f_{IN} + I_{CC}$

Figure 1 AC Characteristics Measurement Circuit

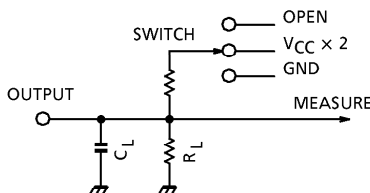

CHARACTERISTICS	SWITCH
t _{PLH} , t _{PHL}	OPEN
t _{PLZ} , t _{PZL}	V _{CC} × 2
t _{PHZ} , t _{PZH}	GND

MARKING

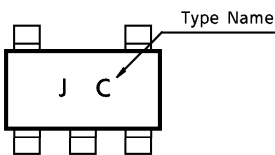

PIN ASSIGNMENT (TOP VIEW)

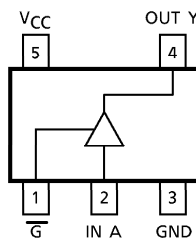

TRUTH TABLE

INPUT		OUTPUT
A	G	Y
x	L	Z
L	H	L
H	H	H

x : Don't Care
 Z : High Impedance

LOGIC DIAGRAM

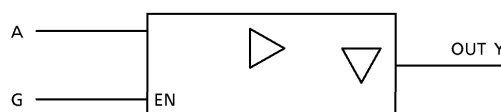

TC7SZ126F, TC7SZ126FU

OUTLINE DRAWING
SSOP5-P-0.95

Unit : mm

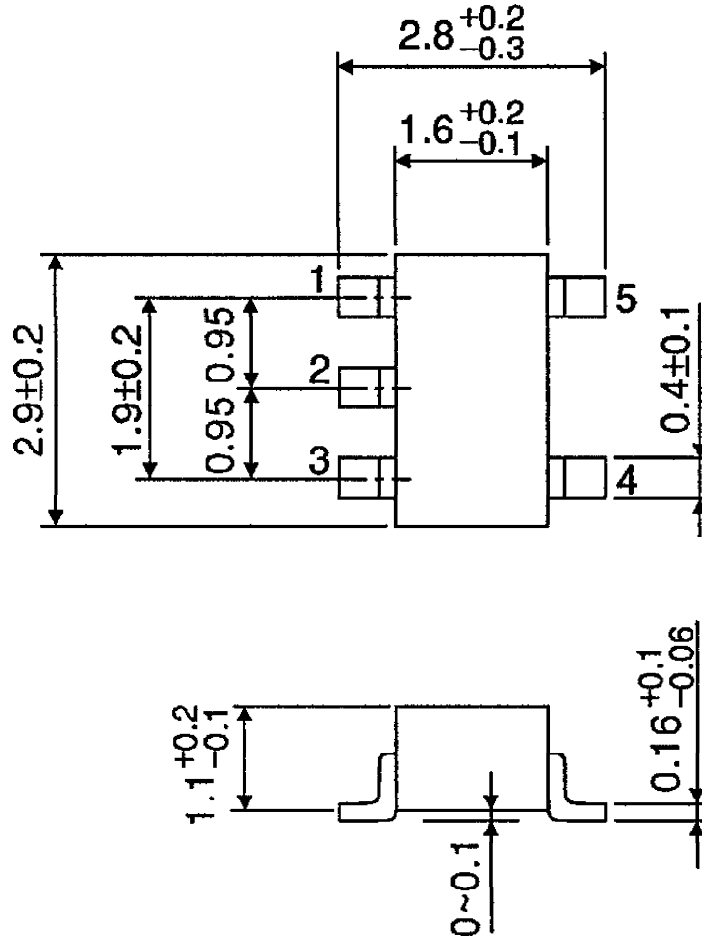

Weight : 0.016 g (Typ.)

TC7SZ126F, TC7SZ126FU

OUTLINE DRAWING
SSOP5-P-0.65A

Unit : mm

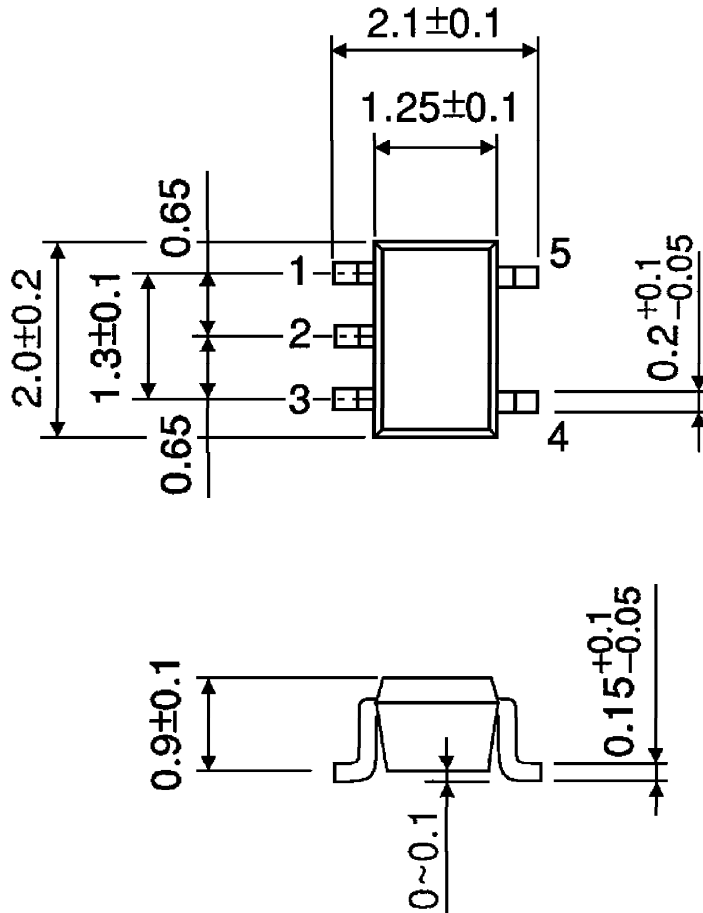

Weight : 0.006 g (Typ.)