

SPECIFICATION

Part No. : WPC.25A.07.0150C

Product Name : 2.4GHz Ceramic Patch Antenna on integral ground with cable and connector

Feature : High antenna RF efficiency
150mm 1.13 IPEX MHFI
RoHS compliant



I Introduction

The WPC.25A 2.4GHz Ceramic Patch Antenna with cable works on Wi-Fi, Zigbee, Bluetooth and ISM band at 2.4GHz. This antenna comprises of a 2.4GHz 25*25*4mm embedded patch with mini-coax cable and connector for connectivity and a PCB carrier to mount the antenna. The WPC.25A is circularly polarized which is more suitable to avoid interference and phase cancellation from reflections. The antenna has its own ground PCB carrier and is therefore ground independent.

II Specification

Wi-Fi	
Frequency (MHz)	2400~2500
Peak Gain (dBi)	> 0.5
Average Gain (dBi)	>-2.5
Efficiency (%)	> 50
Impedance	50Ω
Polarization	RHCP
Input Power	10 W
MECHANICAL	
Dimensions	25*25*5.5mm
Cable type	1.37 mini coaxial cable
Cable length	150mm
Connector	IPEX MHF1
ENVIRONMENTAL	
Temperature Range	-40°C to 85°C
Humidity	Non-condensing 65°C 95% RH

III Antenna Characteristics

III.1 Return loss

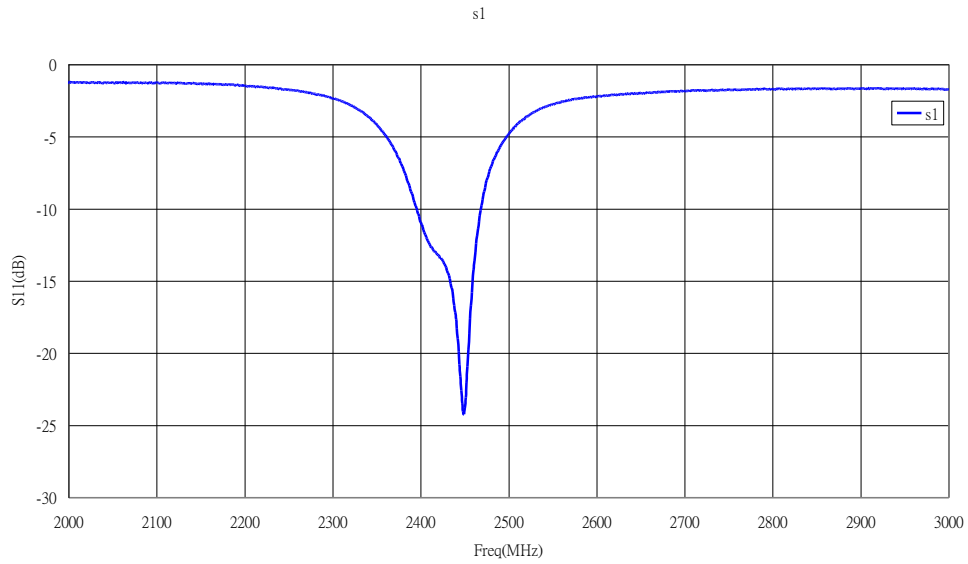

III.2 Antenna Efficiency

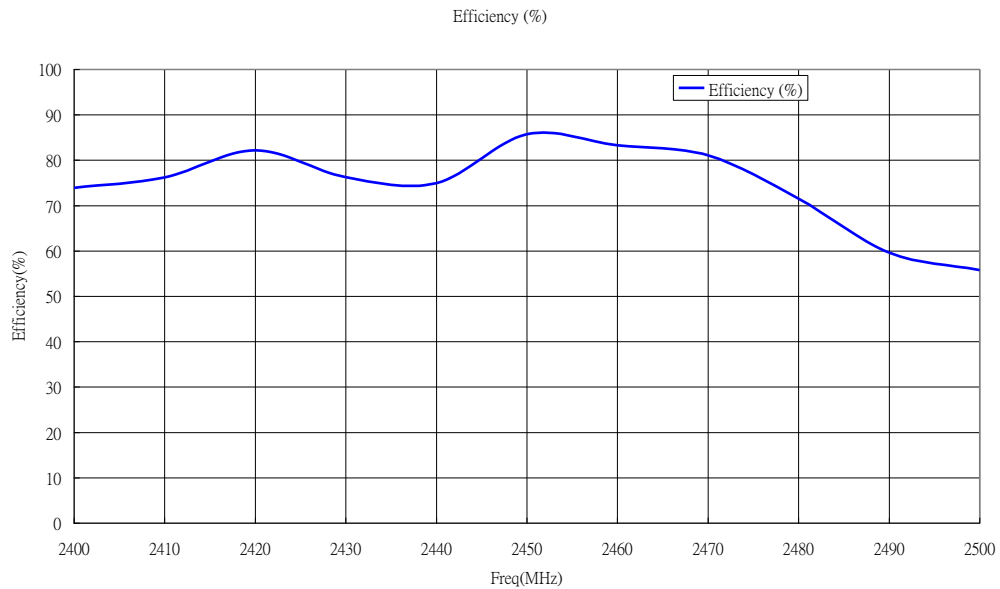

III.3 Peak Gain

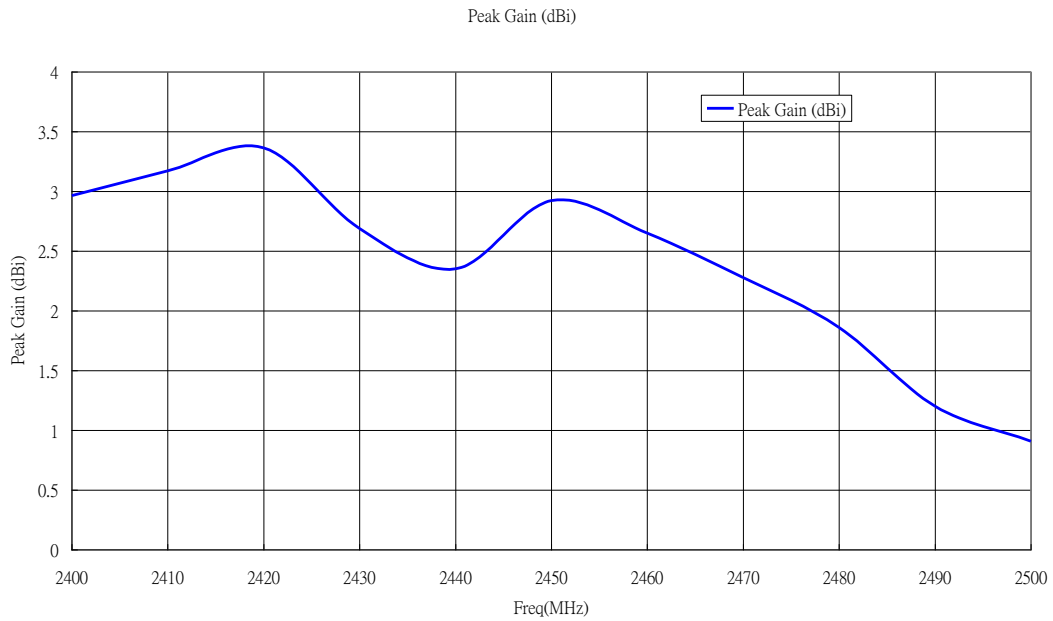

IV Antenna Radiation Pattern

IV.1 Antenna Stand Alone

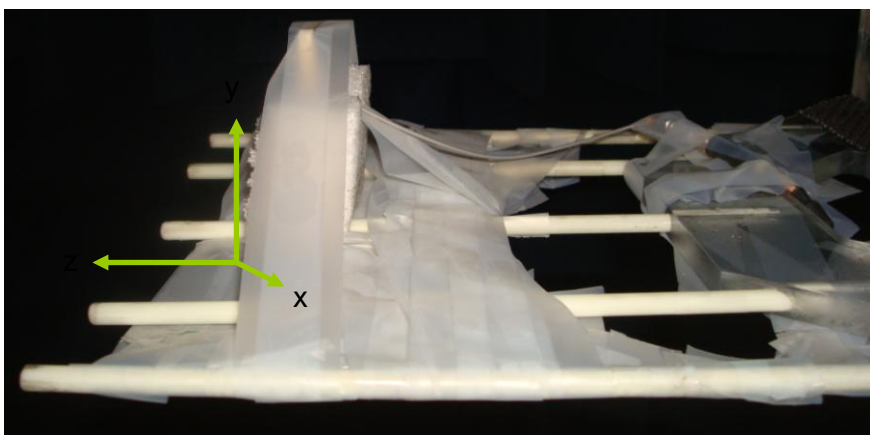

IV.2 XZ plane

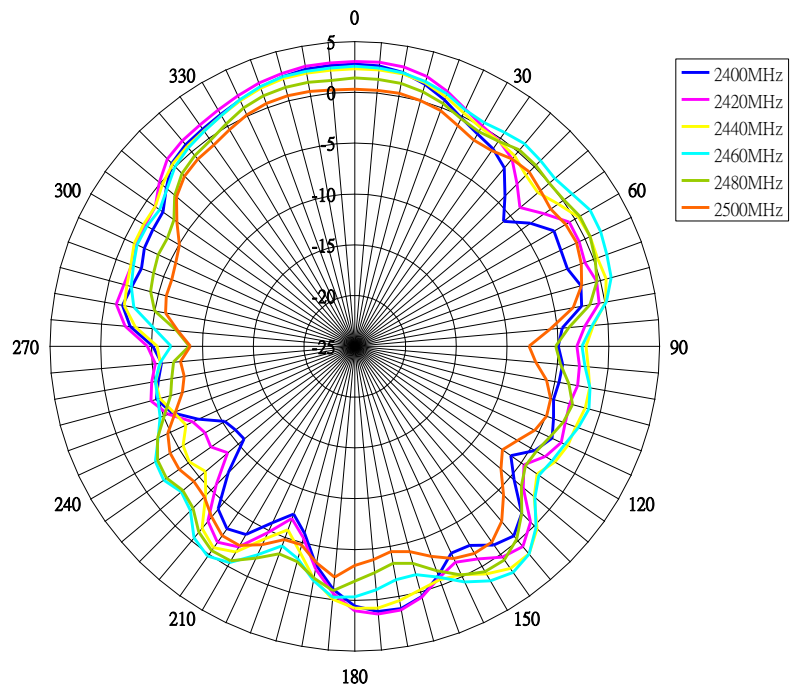

IV.3 YZ plane

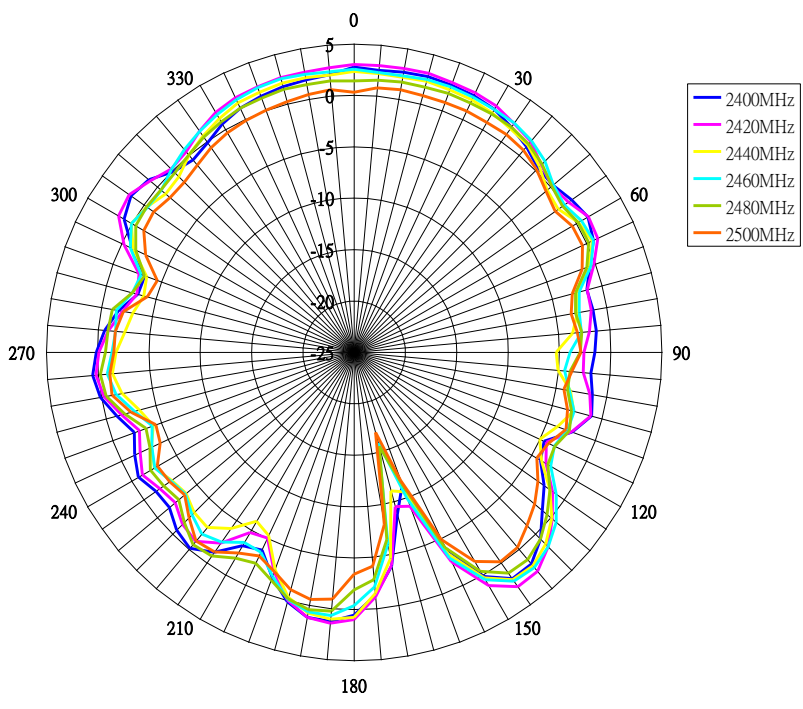

IV.4 XY plane

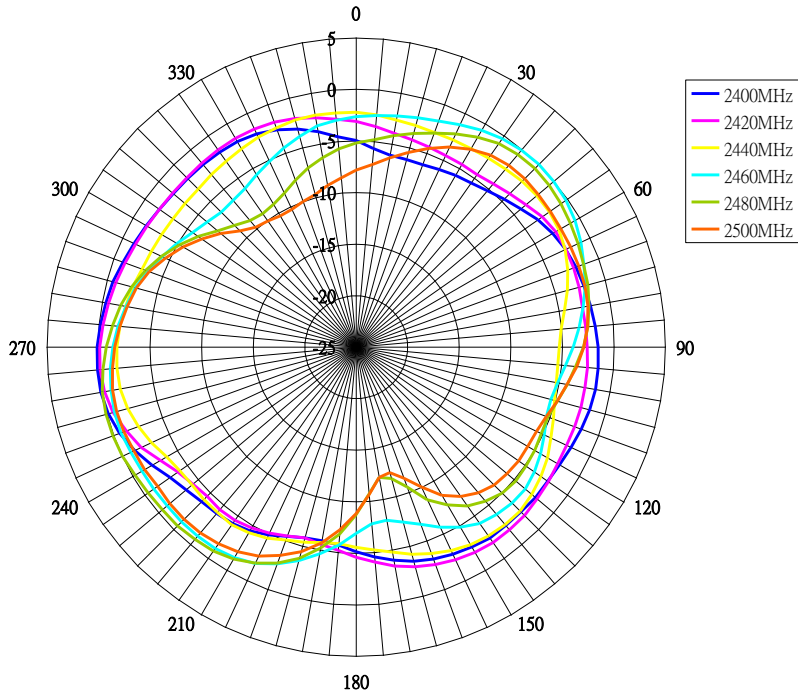

V Mechanical Drawing

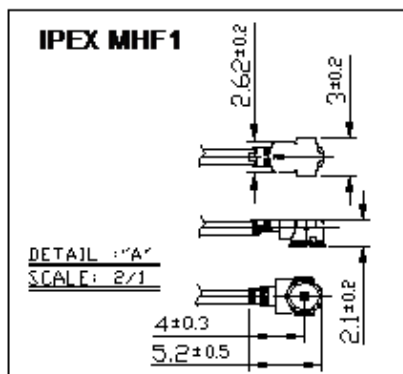
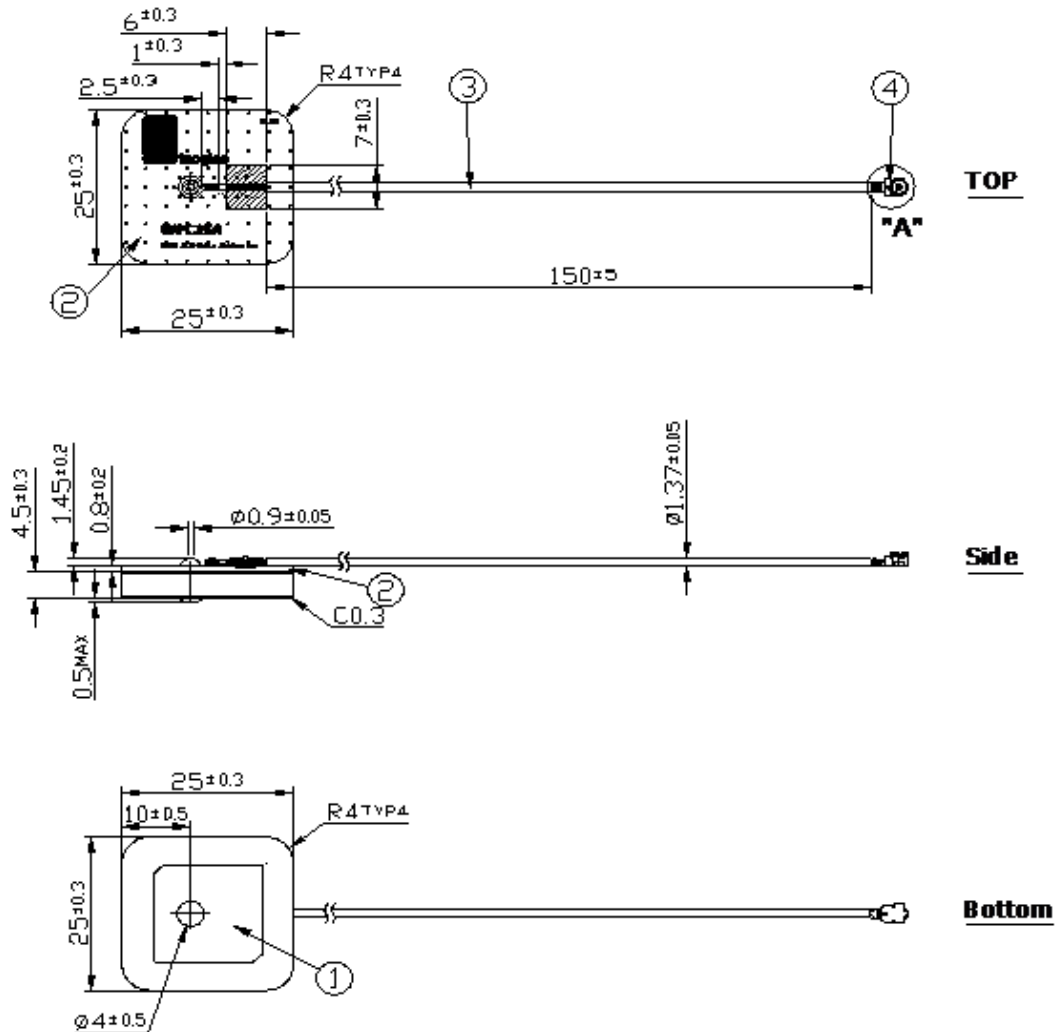

	Name	Material	Finish	QTY
1	WLP.2450 Patch 25x25x4	Ceramic	Clear	1
2	WPC.25A PCB	FR4 D.28	Black	1
3	1.37 Coaxial Cable	FEP	Black/Gray	1
4	IPEX MHF1	Brass	Gold	1

VI Packaging

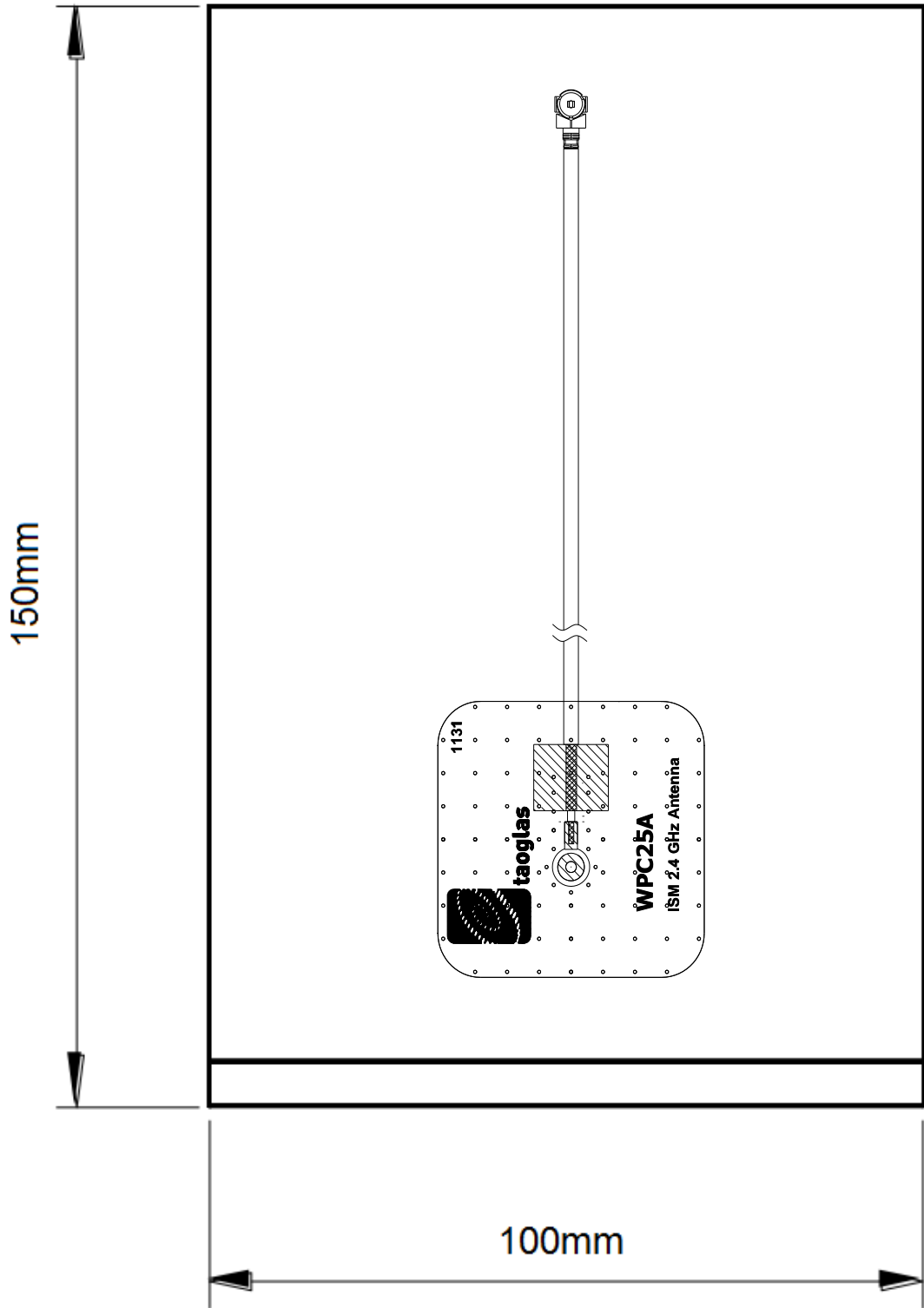

Each Antenna is packaged in a PE Bag 100mm*150mm

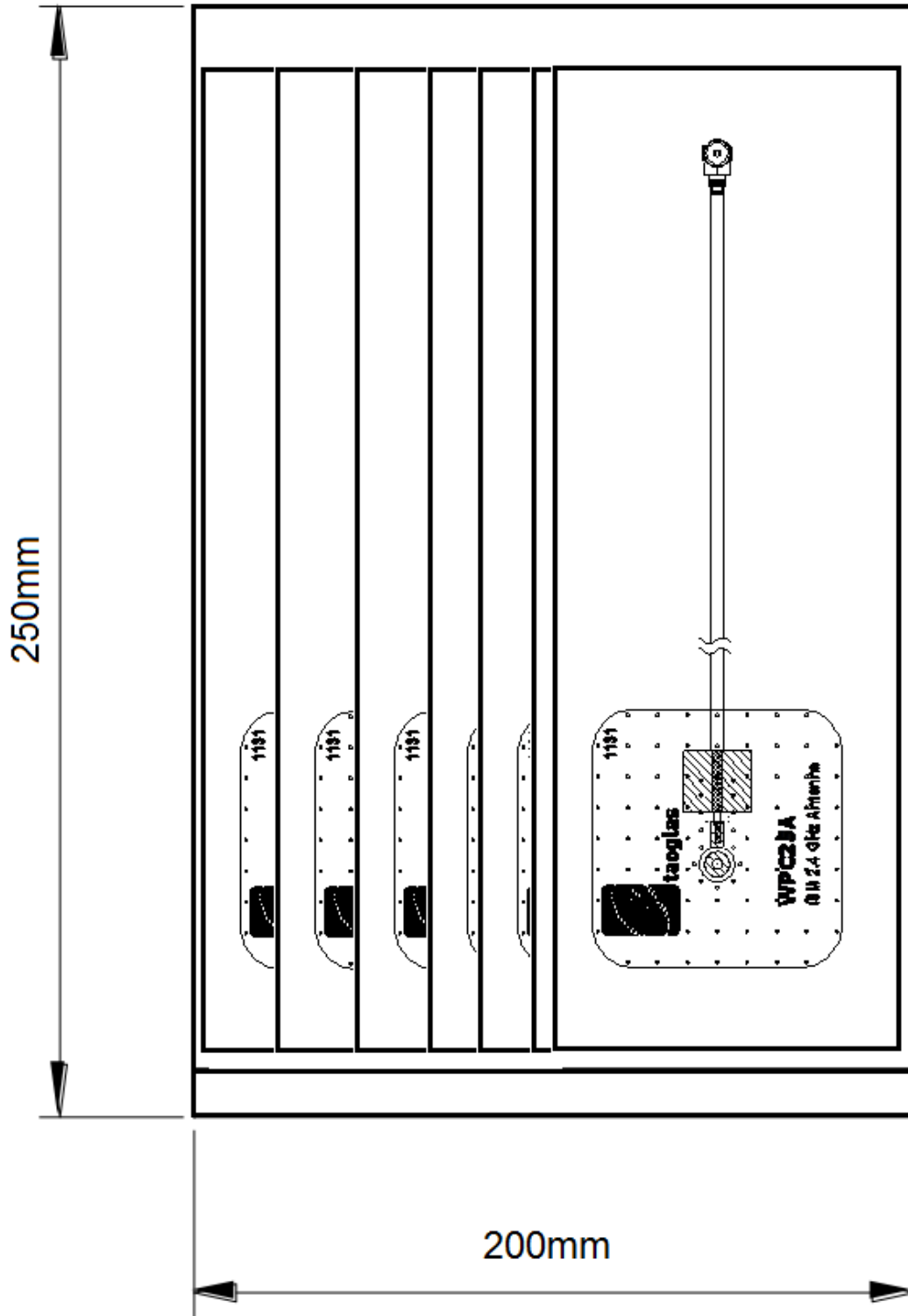

10 Antennas are then packaged in an Outer PE Bag: 250mm*200mm