



Common Mode Filters

For automobile signal line

ACT series

| | |
|---------------|-------------------------------|
| ACT45B | [1812 inch]* (CAN-BUS) |
| ACT45R | [1812 inch] (FlexRay) |
| ACT45L | [1812 inch] (Ethernet) |

* Dimensions Code JIS[EIA]

REMINDERS FOR USING THESE PRODUCTS

Before using these products, be sure to request the delivery specifications.

SAFETY REMINDERS

Please pay sufficient attention to the warnings for safe designing when using these products.

REMINDERS

- The storage period is less than 12 months. Be sure to follow the storage conditions (Temperature: 5 to 40°C, Humidity: 10 to 75% RH or less).
If the storage period elapses, the soldering of the terminal electrodes may deteriorate.
- Do not use or store in locations where there are conditions such as gas corrosion (salt, acid, alkali, etc.).
- Before soldering, be sure to preheat components.
The preheating temperature should be set so that the temperature difference between the solder temperature and chip temperature does not exceed 150°C.
- Soldering corrections after mounting should be within the range of the conditions determined in the specifications.
If overheated, a short circuit, performance deterioration, or lifespan shortening may occur.
- When embedding a printed circuit board where a chip is mounted to a set, be sure that residual stress is not given to the chip due to the overall distortion of the printed circuit board and partial distortion such as at screw tightening portions.
- Self heating (temperature increase) occurs when the power is turned ON, so the tolerance should be sufficient for the set thermal design.
- Carefully lay out the coil for the circuit board design of the non-magnetic shield type.
A malfunction may occur due to magnetic interference.
- Use a wrist band to discharge static electricity in your body through the grounding wire.
- Do not expose the products to magnets or magnetic fields.
- Do not use for a purpose outside of the contents regulated in the delivery specifications.
- The products listed on this catalog are intended for use in general electronic equipment (AV equipment, telecommunications equipment, home appliances, amusement equipment, computer equipment, personal equipment, office equipment, measurement equipment, industrial robots) under a normal operation and use condition.
The products are not designed or warranted to meet the requirements of the applications listed below, whose performance and/or quality require a more stringent level of safety or reliability, or whose failure, malfunction or trouble could cause serious damage to society, person or property.
If you intend to use the products in the applications listed below or if you have special requirements exceeding the range or conditions set forth in the each catalog, please contact us.

- (1) Aerospace/Aviation equipment
- (2) Transportation equipment (electric trains, ships, etc.)
- (3) Medical equipment
- (4) Power-generation control equipment
- (5) Atomic energy-related equipment
- (6) Seabed equipment
- (7) Transportation control equipment

- (8) Public information-processing equipment
- (9) Military equipment
- (10) Electric heating apparatus, burning equipment
- (11) Disaster prevention/crime prevention equipment
- (12) Safety equipment
- (13) Other applications that are not considered general-purpose applications

When designing your equipment even for general-purpose applications, you are kindly requested to take into consideration securing protection circuit/device or providing backup circuits in your equipment.

Common Mode Filters

For automobile signal line

Product compatible with RoHS directive

Compatible with lead-free solders

AEC-Q200

Overview of the ACT Series

FEATURES

- Compatible with an operating temperature range of -40 to $+150^{\circ}\text{C}$, so can be used for vehicle devices requiring compatibility with high temperatures. (ACT45B, ACT45R)
- When mounting, the terminal and winding tape splicing part do not fuse.
- ACT45R for FlexRay, which uses our unique technology, is a product that can achieve $\text{DCR} < 2\Omega @ 125 \text{ deg. C}$ by reducing the DC resistance while maintaining a high L-value of $100\mu\text{H}$.
- ACT45L for Ethernet, which uses our unique technology, is a product that can realize higher-level Scd21 mode conversion characteristics while maintaining a high L-value of $200\mu\text{H}$.

APPLICATION

ACT45B

- CAN-BUS, FAXs, modems, ISDNs, etc.

ACT45R

- FlexRay system.

ACT45L

- Ethernet system.

PART NUMBER CONSTRUCTION

| | | | | | | | | |
|--------------------|---|--|---|------------------------|---|------------------------------------|---|----------------------|
| ACT45B | - | 510 | - | 2P | - | TL | - | □□□ |
| Series name | | Inductance(typ.) (μH) | | Number of lines | | Packaging style | | Internal code |
| ACT45B | | 110 11 | | 2P 2 lines | | TL $\varnothing 330\text{mm}$ reel | | |
| ACT45R | | 220 22 | | | | | | |
| ACT45L | | 510 51 | | | | | | |
| | | 101 100 | | | | | | |
| | | 201 200 | | | | | | |

OPERATING TEMPERATURE RANGE, PACKAGE QUANTITY, PRODUCT WEIGHT

| Type | Temperature range | | Package quantity (pieces/reel) | Individual weight (g) |
|--------|------------------------|------------------------|-----------------------------------|--------------------------|
| | Operating temperature | Storage temperature* | | |
| | ($^{\circ}\text{C}$) | ($^{\circ}\text{C}$) | | |
| ACT45B | -40 to $+150$ | -40 to $+150$ | 2,500 | 0.14 |
| ACT45R | -40 to $+150$ | -40 to $+150$ | 2,500 | 0.14 |
| ACT45L | -40 to $+105$ | -40 to $+105$ | 2,500 | 0.2 |

* The Storage temperature range is for after the circuit board is mounted.

○ RoHS Directive Compliant Product: See the following for more details related to RoHS Directive compliant products. <http://www.tdk.co.jp/rohs/>

• All specifications are subject to change without notice.

Overview of the ACT Series

RECOMMENDED REFLOW PROFILE



| Preheating | | | Soldering | | Peak | |
|------------|-------|------------|-----------|----------|-------|------|
| Temp. | Temp. | Time | Temp. | Time | Temp. | Time |
| T1 | T2 | t1 | T3 | t2 | T4 | t3 |
| 150°C | 180°C | 60 to 120s | 230°C | 40s max. | 245°C | 5s |

ACT series

ACT45B Type



SHAPE & DIMENSIONS

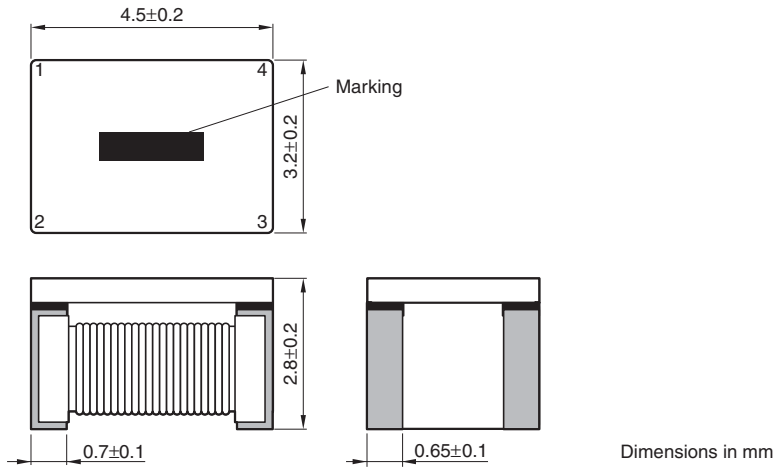

RECOMMENDED LAND PATTERN

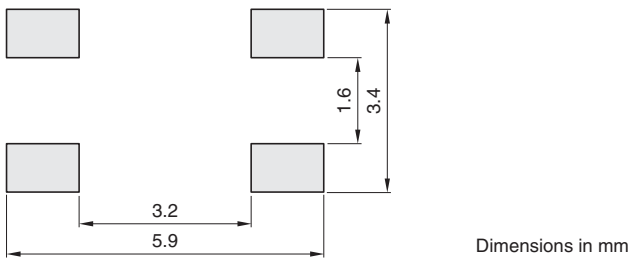

CIRCUIT DIAGRAM

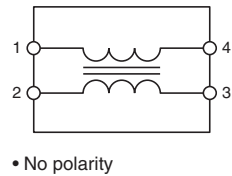

ACT series ACT45B Type

ELECTRICAL CHARACTERISTICS

CHARACTERISTICS SPECIFICATION TABLE

| Common mode impedance (Ω) [10MHz] | | Common mode inductance(μ H) +50/-30% [100kHz] | Stray inductance (μ H)typ. [100kHz] | DC resistance (Ω)max. | Rated current (A)max. | Insulation resistance (M Ω)min. | Rated voltage (V)max. | Part No. |
|--|------|--|---|--------------------------------|-----------------------|---|-----------------------|--------------------|
| min. | typ. | | | | | | | |
| 300 | 600 | 11 | 0.05 | 0.6 | 0.25 | 10 | 50 | ACT45B-110-2PTL□□□ |
| 500 | 1200 | 22 | 0.08 | 1.0 | 0.2 | 10 | 50 | ACT45B-220-2PTL□□□ |
| 1000 | 2800 | 51 | 0.15 | 1.0 | 0.2 | 10 | 50 | ACT45B-510-2PTL□□□ |
| 2000 | 5800 | 100 | 0.20 | 2.0 | 0.15 | 10 | 50 | ACT45B-101-2PTL□□□ |

Measurement equipment

| Measurement item | Product No. | Manufacturer |
|------------------------|-------------|----------------------|
| Common mode impedance | 4991A | Agilent Technologies |
| Common mode inductance | 4294A | Agilent Technologies |
| DC resistance | 4338A | Agilent Technologies |
| Insulation resistance | 4339A | Agilent Technologies |

* Equivalent measurement equipment may be used.

IMPEDANCE VS. FREQUENCY CHARACTERISTICS

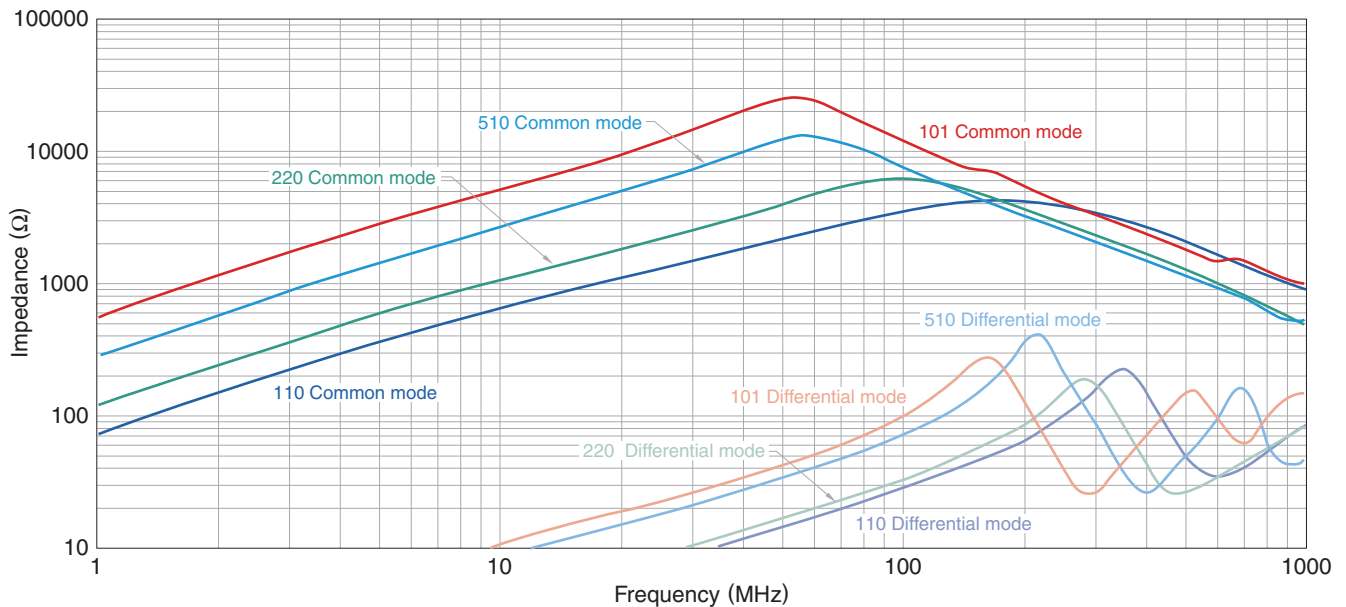

Measurement equipment

| Product No. | Manufacturer |
|-------------|----------------------|
| 4991A | Agilent Technologies |

* Equivalent measurement equipment may be used.

ACT series

ACT45R Type



SHAPE & DIMENSIONS

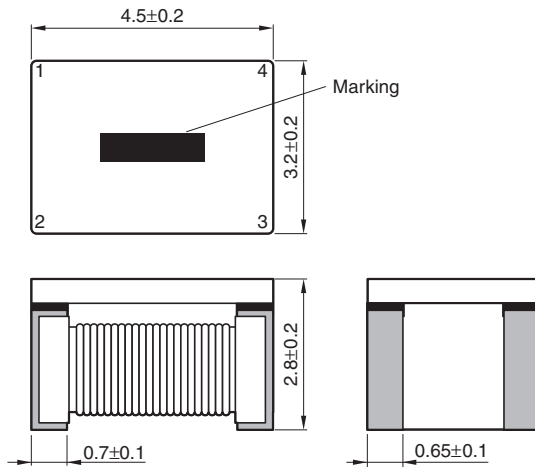

RECOMMENDED LAND PATTERN

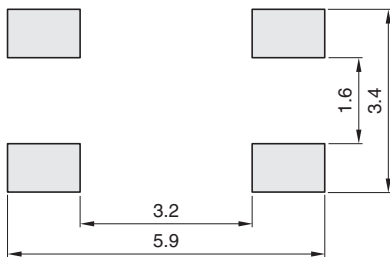

CIRCUIT DIAGRAM

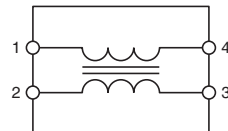

- No polarity

ACT series ACT45R Type

ELECTRICAL CHARACTERISTICS

CHARACTERISTICS SPECIFICATION TABLE

| Common mode impedance (Ω) [10MHz] | | Common mode inductance(μ H) +50/-30% [100kHz] | Stray inductance (μ H)typ. [100kHz] | DC resistance (Ω)max. | Rated current (A)max. | Insulation resistance (M Ω)min. | Rated voltage (V)max. | Part No. |
|--|------|--|---|--------------------------------|-----------------------|---|-----------------------|---------------------|
| min. | typ. | | | | | | | |
| 2200 | 5500 | 100 | 0.2 | 1.5 | 0.2 | 10 | 50 | ACT45R-101-2P-TL001 |

Measurement equipment

| Measurement item | Product No. | Manufacturer |
|------------------------|-------------|----------------------|
| Common mode impedance | 4991A | Agilent Technologies |
| Common mode inductance | 4294A | Agilent Technologies |
| DC resistance | 4338A | Agilent Technologies |
| Insulation resistance | 4339A | Agilent Technologies |

* Equivalent measurement equipment may be used.

IMPEDANCE VS. FREQUENCY CHARACTERISTICS

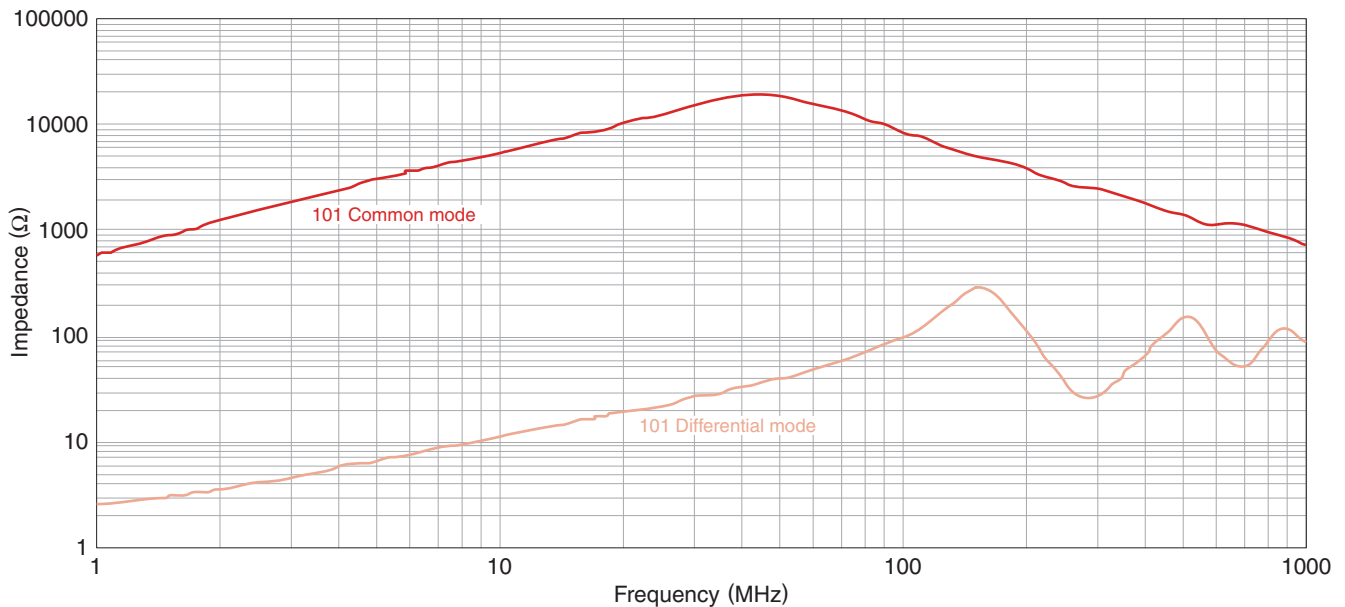

Measurement equipment

| Product No. | Manufacturer |
|-------------|----------------------|
| 4991A | Agilent Technologies |

* Equivalent measurement equipment may be used.

ACT series

ACT45L Type



■ SHAPE & DIMENSIONS

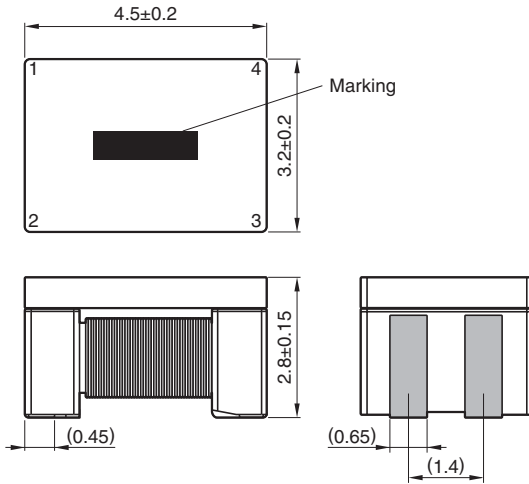

Dimensions in mm

■ RECOMMENDED LAND PATTERN

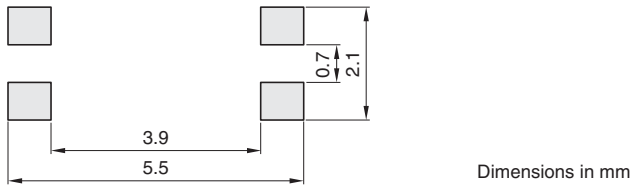

Dimensions in mm

■ CIRCUIT DIAGRAM

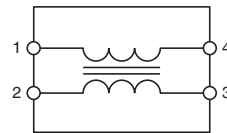

• No polarity

ACT series ACT45L Type

ELECTRICAL CHARACTERISTICS

CHARACTERISTICS SPECIFICATION TABLE

| Common mode inductance (μH)typ. [100kHz] | DC resistance (Ω)max. | Rated current (mA)max. | Insulation resistance ($\text{M}\Omega$)min. | Rated voltage (V)max. | Part No. |
|---|--------------------------------|------------------------|--|-----------------------|---------------------|
| 200 | 4.5 | 100 | 10 | 50 | ACT45L-201-2P-TL000 |

Measurement equipment

| Measurement item | Product No. | Manufacturer |
|------------------------|-------------|----------------------|
| Common mode inductance | 4294A | Agilent Technologies |
| DC resistance | 4338A | Agilent Technologies |
| Insulation resistance | 4339A | Agilent Technologies |

* Equivalent measurement equipment may be used.

IMPEDANCE VS. FREQUENCY CHARACTERISTICS

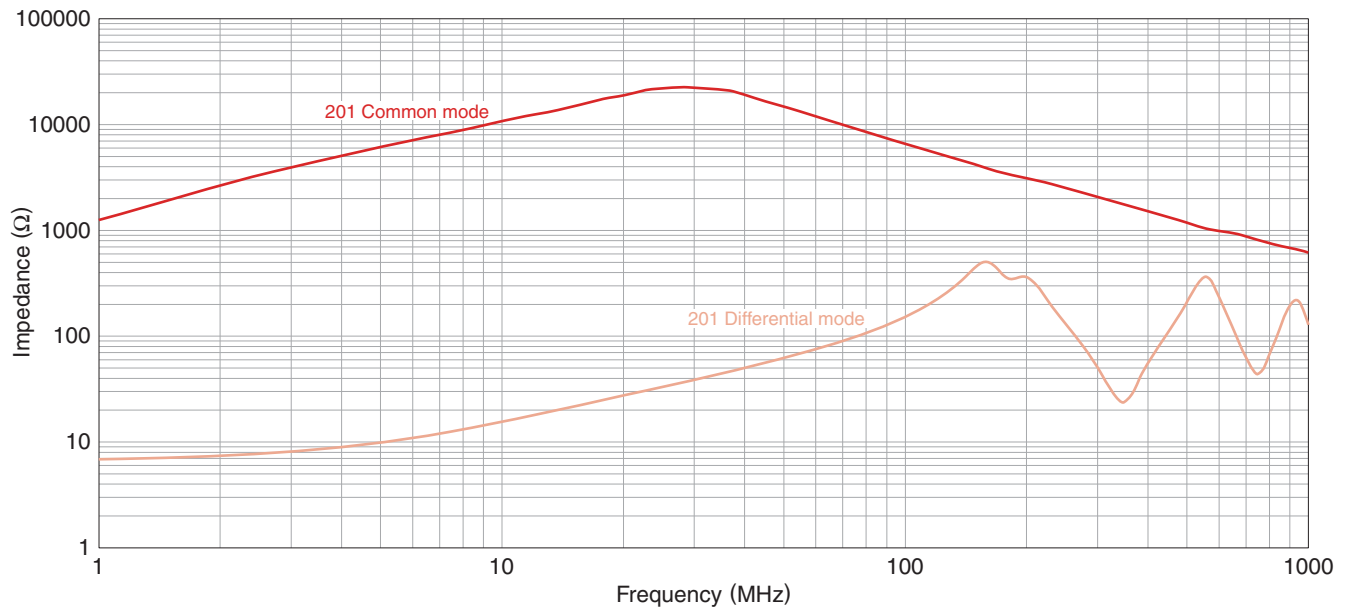

Measurement equipment

| Product No. | Manufacturer |
|-------------|----------------------|
| 4294A | Agilent Technologies |

* Equivalent measurement equipment may be used.

ACT series

Packaging style

REEL DIMENSIONS

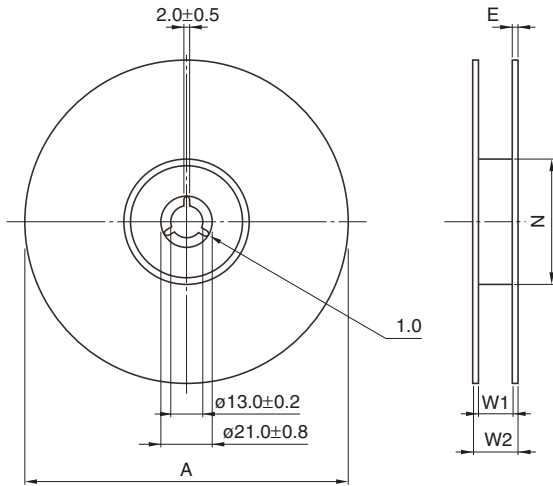

Dimensions in mm

| Type | A | W1 | W2 | N | E |
|--------|------------------|----------------|--------------|-------------|--------|
| ACT45B | $\phi 330 \pm 2$ | 13.5 ± 0.5 | 17.5 ± 1 | 100 ± 1 | 2 typ. |
| ACT45R | $\phi 330 \pm 2$ | 13.5 ± 0.5 | 17.5 ± 1 | 100 ± 1 | 2 typ. |
| ACT45L | $\phi 330 \pm 2$ | 13.5 ± 0.5 | 17.5 ± 1 | 100 ± 1 | 2 typ. |

TAPE DIMENSIONS

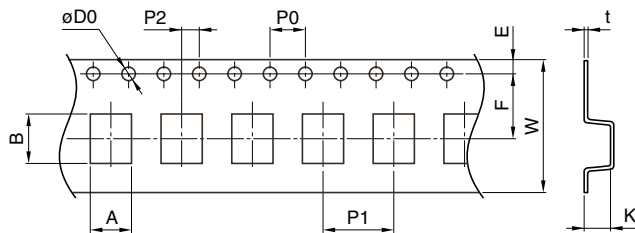

Dimensions in mm

| Type | A | B | $\phi D0$ | E | F | P0 | P1 | P2 | W | K | t |
|--------|---------------|---------------|-----------------|----------------|----------------|---------------|---------------|----------------|----------------|----------------|----------------|
| ACT45B | 3.6 ± 0.1 | 4.9 ± 0.1 | 1.55 ± 0.05 | 1.75 ± 0.1 | 5.5 ± 0.05 | 4.0 ± 0.1 | 8.0 ± 0.1 | 2.0 ± 0.05 | 12.0 ± 0.2 | 3.05 ± 0.1 | 0.3 ± 0.05 |
| ACT45R | 3.6 ± 0.1 | 4.9 ± 0.1 | 1.55 ± 0.05 | 1.75 ± 0.1 | 5.5 ± 0.05 | 4.0 ± 0.1 | 8.0 ± 0.1 | 2.0 ± 0.05 | 12.0 ± 0.2 | 3.05 ± 0.1 | 0.3 ± 0.05 |
| ACT45L | 3.6 ± 0.1 | 4.9 ± 0.1 | 1.55 ± 0.05 | 1.75 ± 0.1 | 5.5 ± 0.05 | 4.0 ± 0.1 | 8.0 ± 0.1 | 2.0 ± 0.05 | 12.0 ± 0.2 | 3.05 ± 0.1 | 0.3 ± 0.05 |

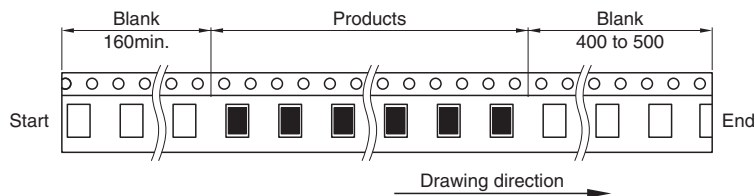

Dimensions in mm

• All specifications are subject to change without notice.