

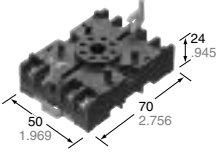

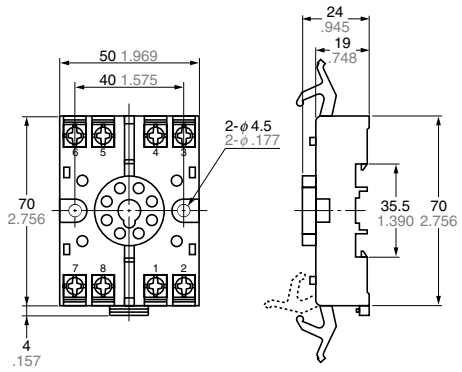
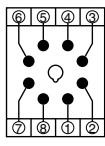
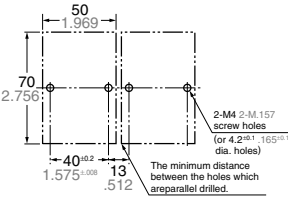
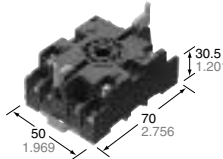
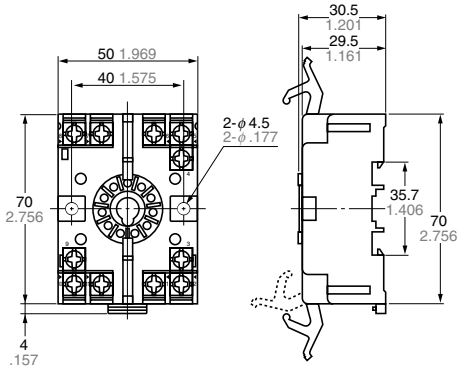
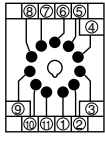
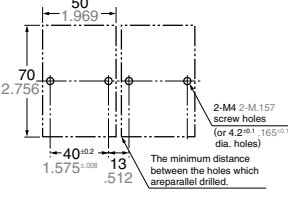

DIN SIZE TIMERS COMMON OPTIONS

Terminal sockets (Unit: mm inch, Tolerance: $\pm 1 \pm .039$)

Type	Appearance	Dimensions	Terminal wiring (Top view)	Mounting hole dimensions
PM4H-S PM4H-M PM4H-SD PM4H-F8 PM4H-F8R PM4H-W LT4H LT4H-W (8-pin type)	<ul style="list-style-type: none"> DIN rail socket (8-pin)  <p>ATC180031</p>		 <p>Note: Terminal No. on the main body are identical to those on the terminal socket.</p>	
PM4H-A PM4H-F11R LT4H LT4H-W (11-pin type)	<ul style="list-style-type: none"> DIN rail socket (11-pin)  <p>ATC180041</p>		 <p>Note: Terminal No. on the main body are identical to those on the terminal socket.</p>	

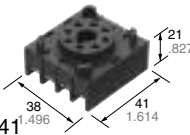
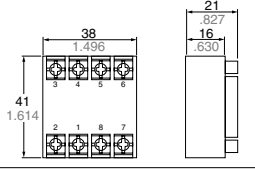
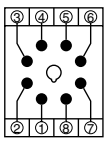
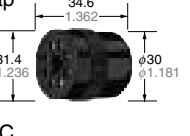
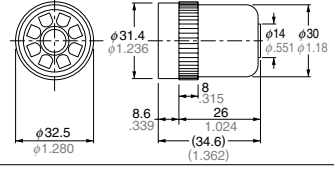
Note: The socket's numbering system matches that of the timer terminals.

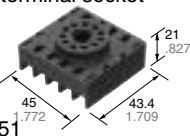
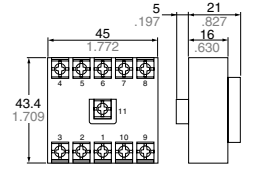
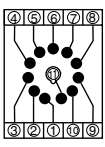
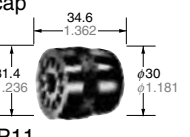
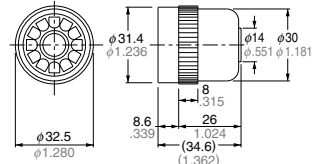
Sockets (Unit: mm inch, Tolerance: $\pm 1 \pm .039$)

Type	Appearance	Dimensions	Terminal wiring (Top view)	Mounting hole dimensions
PM4H-S PM4H-M PM4H-SD PM4H-F8 PM4H-F8R PM4H-W LT4H LT4H-W (8-pin type)	<ul style="list-style-type: none"> Rear terminal socket  <p>AT78041</p>			—
PM4H-W LT4H LT4H-W (8-pin type)	<ul style="list-style-type: none"> 8P cap  <p>AD8-RC</p>			—
PM4H-A PM4H-F11R LT4H LT4H-W (11-pin type)	<ul style="list-style-type: none"> Rear terminal socket  <p>AT78051</p>			—
PM4H-W LT4H-W (11-pin type)	<ul style="list-style-type: none"> 11P cap  <p>AT8-DP11</p>			—

Note: The terminal socket's numbering system matches that of the timer terminals.

Mounting parts

• Rubber gasket

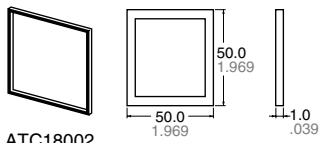

ATC18002

Applicable for PM4H and LT4H series

The rubber gasket is enclosed in the PM4H (screw terminal type) and the LT4H series.

• Mounting frame

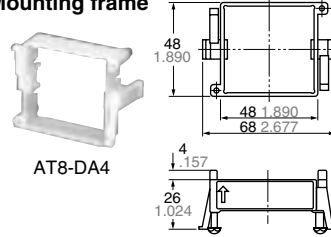

AT8-DA4

Applicable for PM4H and LT4H series

The mounting frame is enclosed in the PM4H (screw terminal type) and the LT4H series.

• Mounting rails (Applicable for DIN and IEC standards)



AT8-DLA1
Length: 1 m
aluminum

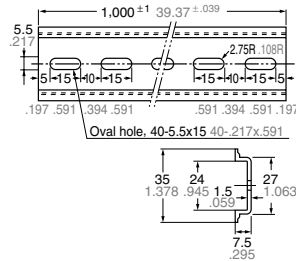

• Fastening plate



ATA4806

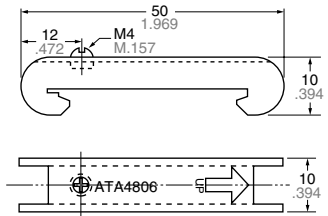

For holding DIN rails

ACCESSORIES

PM4H series

• Panel cover (Black)

PM4H-A



ATC18011

PM4H-S



ATC18012

PM4H-M



ATC18013

PM4H-W



ATC18014

PM4H-SD



ATC18015

PM4H-F



ATC18016

LT4H series

• Panel cover (Black)

LT4H



ATL58011

LT4H-W



ATL68011

The black panel cover is also available so that you can change the appearance of the panel by changing the panel cover. The color of the standard panel cover is ash gray.

• Set ring

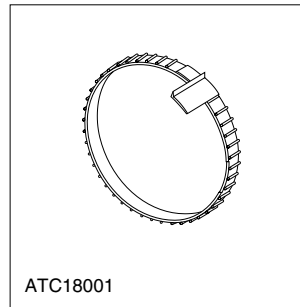

ATC18001

When you control the fixed time range, the setting rings (a set of 2 pcs.) make it easy to do the time setting and keep the time range all the time. (Excluding PM4H-W)