

DELPHI SERIES



FEATURES

- High Efficiency:
94% @ 12Vin, 5.0V/80A out
- Wide input range: 10.8V~13.2V
- Output voltage programmable from 0.8375Vdc to 5.0Vdc via external resistors
- No minimum load required
- Fixed frequency operation
- Input UVLO, output OCP, OVP, OTP.
- Remote On/Off (Positive logic)
- Power Good Function
- RoHS 6/6 compliant
- ISO 9001, TL 9000, ISO 14001, QS9000, OHSAS18001 certified manufacturing facility
- UL/cUL 60950 (US & Canada) Recognized

Delphi D12S400 Non-Isolated Point of Load DC/DC Modules: 10.8~13.2Vin, 0.8375~5.0V/ 80A output

The D12S400, 10.8~13.2V wide input, single output, non-isolated point of load DC/DC converter is the latest offering from a world leader in power systems technology and manufacturing -- Delta Electronics, Inc. The D12S400 and ND/NE product families are part of the second generation, non-isolated point-of-load DC/DC power modules which cut the module size by almost 50% in most of the cases compared to the first generation NC series POL modules for networking and data communication applications. D12S400 product provides up to 80A in the same form factor of the second generation 60A datacom POLs and the output can be resistor trimmed from 0.8375Vdc to 5.0Vdc. It provides a highly efficient, high power and current density and very cost effective point of load solution. With creative design technology and optimization of component placement, these converters possess outstanding electrical and thermal performance, as well as extremely high reliability under highly stressful operating conditions.

APPLICATIONS

- Telecom / DataCom
- Distributed power architectures
- Servers and workstations
- LAN / WAN applications
- Data processing applications

TECHNICAL SPECIFICATIONS

(All data below are tested at operating ambient temperature 25°C, air flow 300LFM, 5.0Vout, unless otherwise stated.)

PARAMETER	NOTES and CONDITIONS	D12S400			
		Min.	Typ.	Max.	Units
ABSOLUTE MAXIMUM RATINGS					
Input Voltage	Continuous	-0.3		13.8	V
Operating Temperature	With appropriate air flow and de-rating as Figure 28	0		85	°C
Storage Temperature		-40		125	°C
INPUT CHARACTERISTICS					
Operating Input Voltage	$V_o > 1.8V$	10.8	12.0	13.2	V
Operating Input Voltage	$V_o \leq 1.8V$	5.0		13.2	V
Input Under-Voltage Lockout					
Turn-On Voltage Threshold	$V_o \leq 3.3V, I_o=1A$		4.8		V
Turn-Off Voltage Threshold	$V_o \leq 3.3V, I_o=1A$		4.5		V
Lockout Hysteresis Voltage			0.3		V
Maximum Input Current	100%Load, 12Vin, 5.0Vout			38	A
No-Load Input Current	Total input range		750		mA
Off Converter Input Current	Remote OFF, Vin=12V		35		mA
OUTPUT CHARACTERISTICS					
Output Voltage Adjustment Range		0.8375		5.0	V
Output Voltage Set Point	Measured at remote sense pin	-1.5		+1.5	%Vo
Output Voltage Regulation					
Over Load	$I_o=I_{o_min}$ to I_{o_max}	-0.5		+0.5	%Vo
Over Line	$V_{in}=V_{in_min}$ to V_{in_max}	-0.5		+0.5	%Vo
Over Temperature	Tc=0°C to 85°C	-1.0		+1.0	°C
Total output range	Over load, line, temperature regulation and set point	-3.5		+3.5	%Vo
Output Voltage Ripple and Noise	5Hz to 20MHz bandwidth				
Peak-to-Peak	Full Load, 10uF Tan cap & 1uF ceramic, total input & output range			50	mV
RMS	Full Load, 10uF Tan cap & 1uF ceramic, total input & output range			20	mV
Output Current Range		0		80	A
Output Voltage Over-shoot at Start-up	All conditions		0.5	2	% of Vo
Output Voltage Under-shoot at Power-Off	Vin=12V, Turn OFF			100	mV
Output DC Current-Limit Inception	Hiccup mode		135		%Iomax
DYNAMIC CHARACTERISTICS					
Output Dynamic Load Response	Without output cap.				
Positive Step Change in Output Current	12Vin, 5.0Vout, 0A to 20A, 10A/uS		170		mV
Negative Step Change in Output Current	12Vin, 5.0Vout, 20A to 0A, 10A/uS		170		mV
Settling Time	Settling to be within regulation band (to 10% Vo deviation)		20		µs
Turn-On Transient					
Start-Up Time, from On/Off Control	From Enable high to 90% of Vo			5	ms
Start-Up Time, from input power	From Vin=12V to 90% of Vo			10	ms
Power Good Delay	All conditions (within 90% of Vo(set))			2	ms
Minimum Output Capacitance		0			µF
Maximum Output Startup Capacitive Load	ESR $\geq 1m\Omega$	0		5000	µF
Minimum Input Capacitance		2200			µF
EFFICIENCY					
Vo=1.0V	Vin=12V, Io=80A		85.0		%
Vo=1.2V	Vin=12V, Io=80A		86.0		%
Vo=1.5V	Vin=12V, Io=80A		88.5		%
Vo=1.8V	Vin=12V, Io=80A		89.5		%
Vo=2.5V	Vin=12V, Io=80A		91.5		%
Vo=3.3V	Vin=12V, Io=80A		92.5		%
Vo=5.0V	Vin=12V, Io=80A		94.0		%
FEATURE CHARACTERISTICS					
Switching Frequency	Fixed, Per phase		500		KHz
ON/OFF Control	Positive logic (internally pulled high)				
Logic High	Module On (or leave the pin open)	4.5		5.5	V
Logic Low	Module Off	-0.3		0.5	V
GENERAL SPECIFICATIONS					
Calculated MTBF	12Vin, 5.0Vout, Full load, 55°C, 400LFM		1.0		M hours
	12Vin, 5.0Vout, Full load, 25°C, 400LFM		1.4		M hours
Weight			35.0		grams
Over-Temperature Shutdown	Refer to Figure 28 for the measuring point		125		°C



ELECTRICAL CHARACTERISTICS CURVES

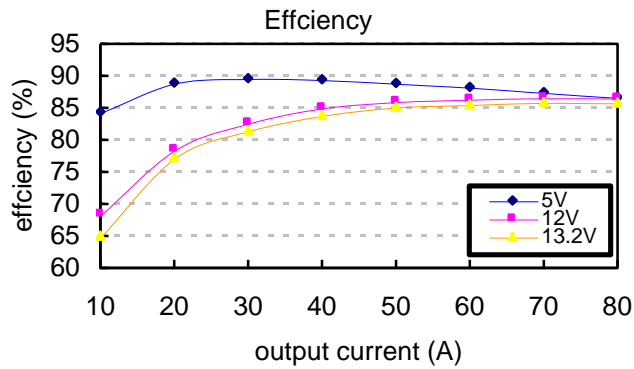

Figure 1: Converter efficiency vs. output current (1.2V output voltage)

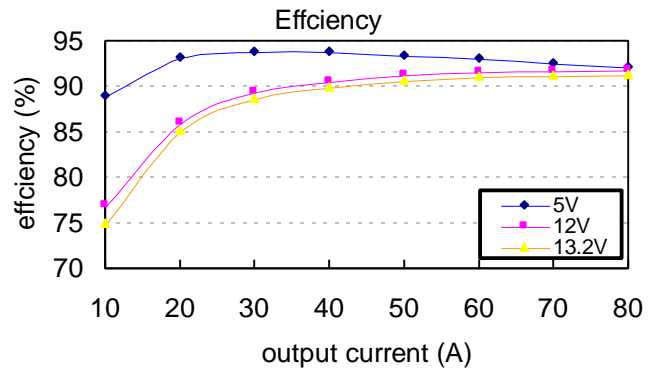

Figure 2: Converter efficiency vs. output current (1.5V output voltage)

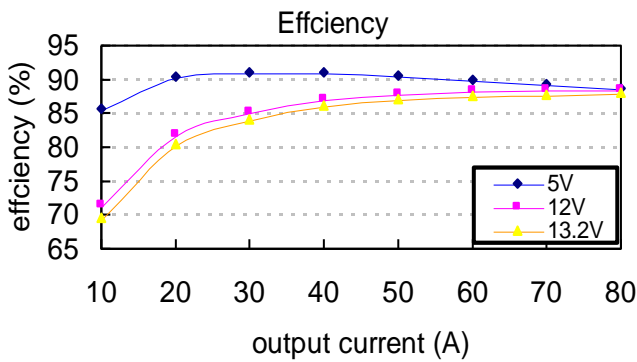

Figure 3: Converter efficiency vs. output current (1.8V output voltage)

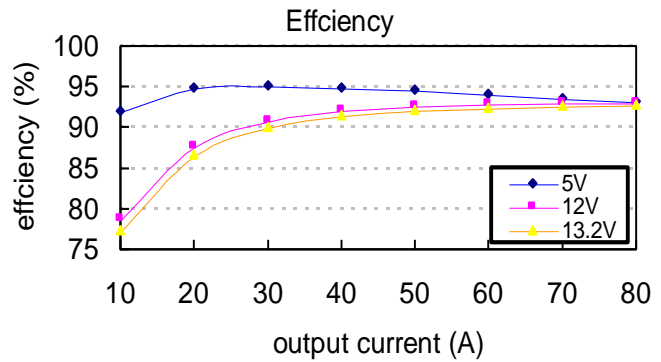

Figure 4: Converter efficiency vs. output current (2.5V output voltage)

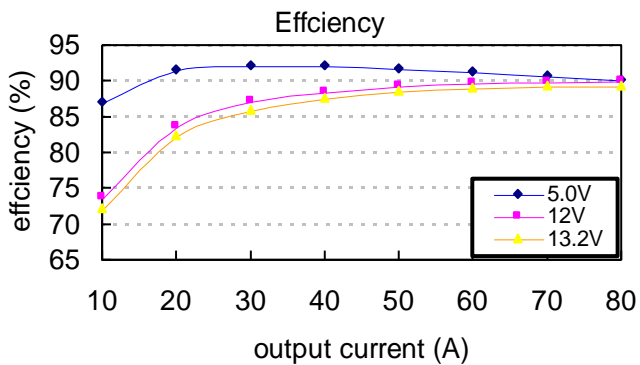

Figure 5: Converter efficiency vs. output current (3.3V output voltage)

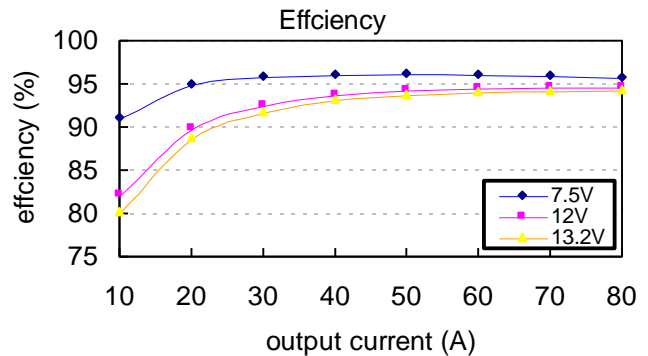

Figure 6: Converter efficiency vs. output current (5.0V output voltage)

NOTE: REMOVE THE 5V INPUT APPLICATIONS.



ELECTRICAL CHARACTERISTICS CURVES (CONTINUED)

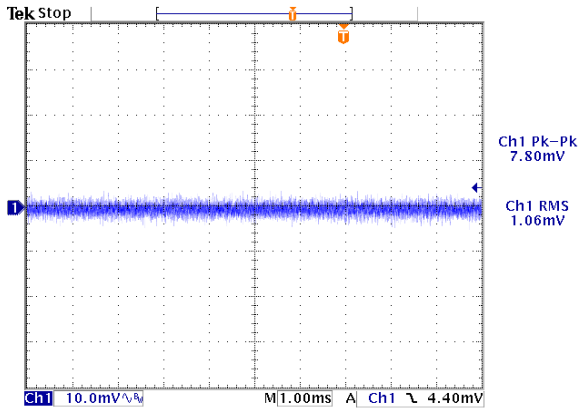

Figure 7: Output ripple & noise at 12Vin, 1.2V/80A out (10mv/div, 1mS/div)

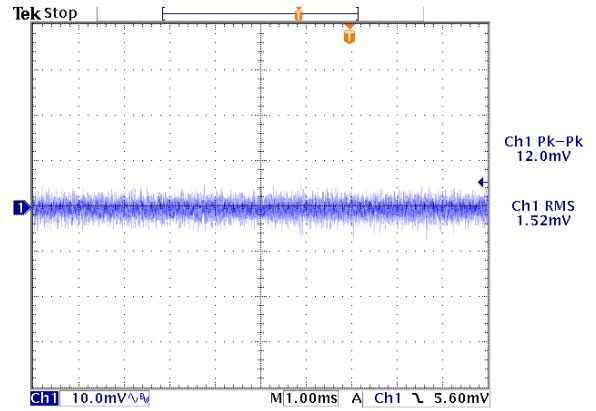

Figure 8: Output ripple & noise at 12Vin, 1.5V/80A out (10mv/div, 1mS/div)

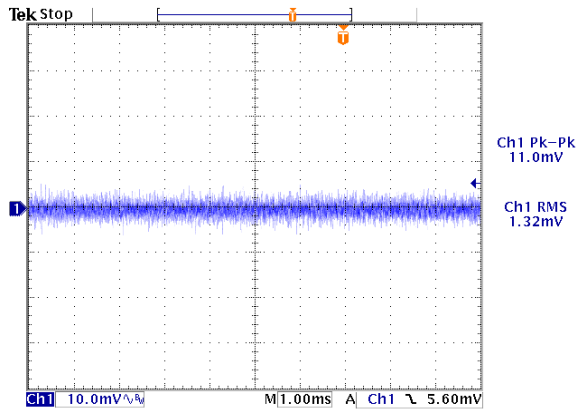

Figure 9: Output ripple & noise at 12Vin, 1.8V/80A out (10mv/div, 1mS/div)

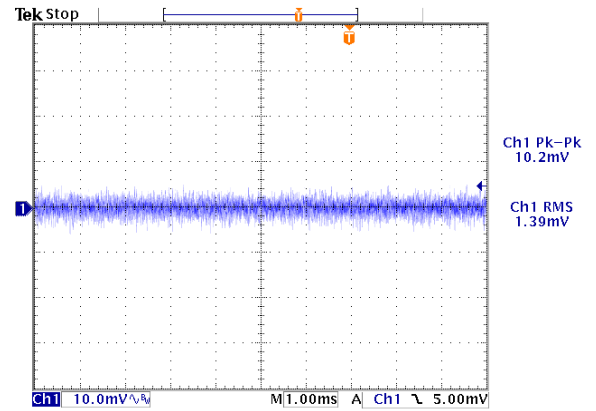

Figure 10: Output ripple & noise at 12Vin, 2.5V/80A out (10mv/div, 1mS/div)

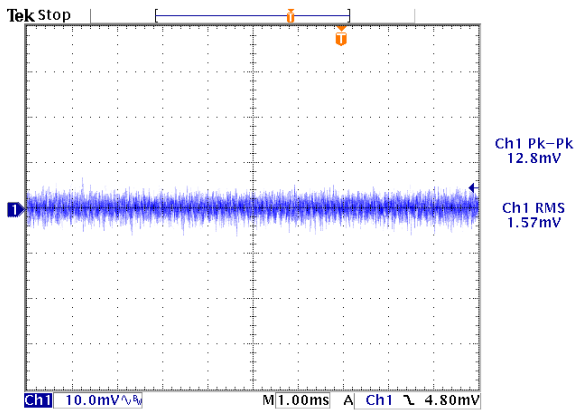

Figure 11: Output ripple & noise at 12Vin, 3.3V/80A out (10mv/div, 1mS/div)

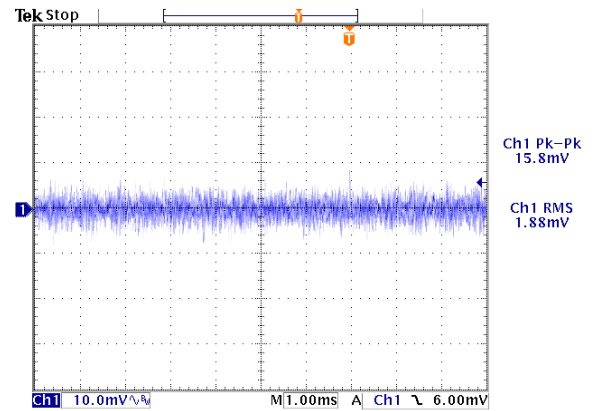

Figure 12: Output ripple & noise at 12Vin, 5.0V/80A out (10mv/div, 1mS/div)



ELECTRICAL CHARACTERISTICS CURVES (CONTINUED)

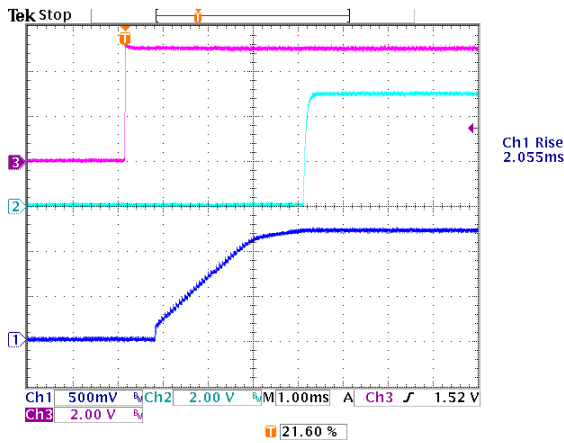

Figure 13: Control Turn on, 1.2V/80A out
Ch1: Vo, Ch2:PG, Ch3:Enable

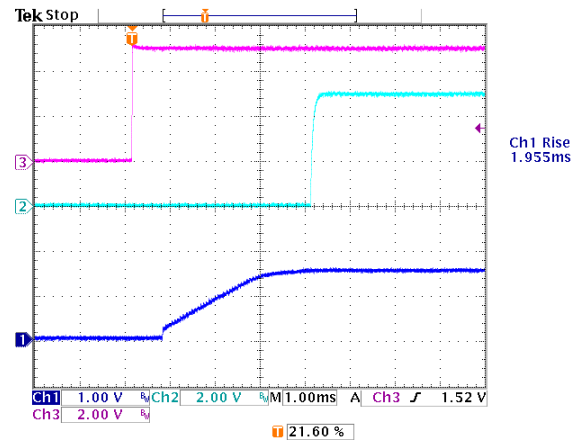

Figure 14: Control Turn on, 1.5V/80A out
Ch1: Vo, Ch2:PG, Ch3:Enable

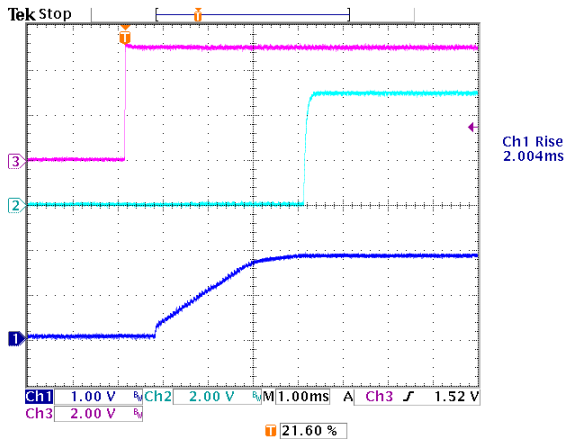

Figure 15: Control Turn on, 1.8V/80A out
Ch1: Vo, Ch2:PG, Ch3:Enable

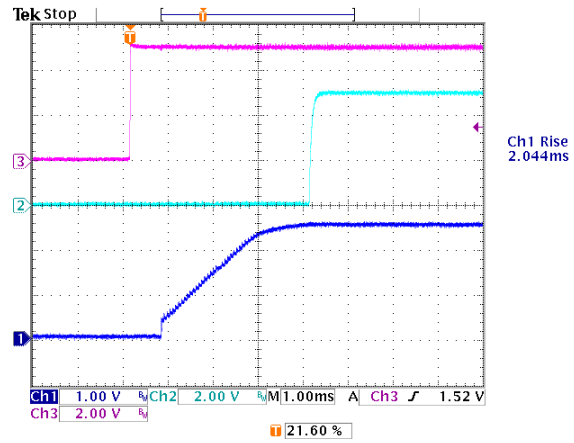

Figure 16: Control Turn on, 2.5V/80A out
Ch1: Vo, Ch2:PG, Ch3:Enable

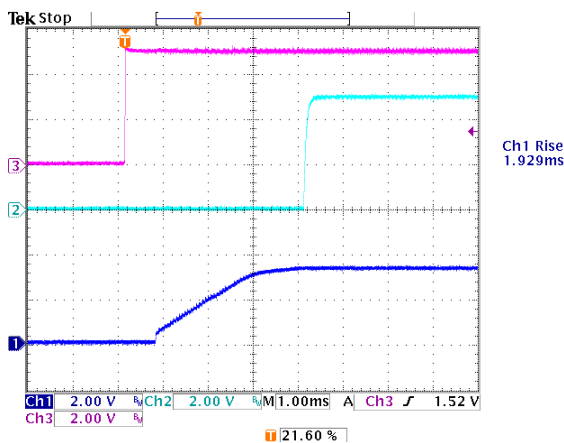

Figure 17: Control Turn on, 3.3V/80A out
Ch1: Vo, Ch2:PG, Ch3:Enable

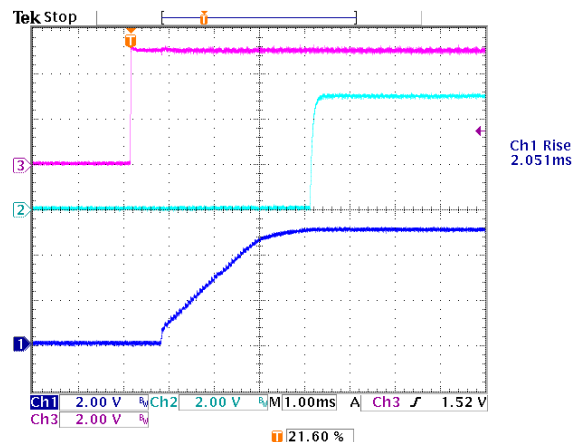

Figure 18: Control Turn on, 5V/80A out
Ch1: Vo, Ch2:PG, Ch3:Enable



ELECTRICAL CHARACTERISTICS CURVES (CONTINUED)

Test condition: Slew rate: 10A/us, Load Step: 25% of max. load, Output without Caps.

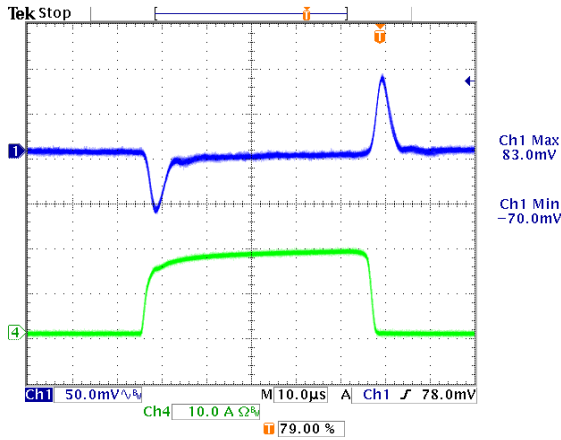

Figure 19: Typical transient response, 1.2V output
CH1:Vo, Ch4:I_o,10A/div

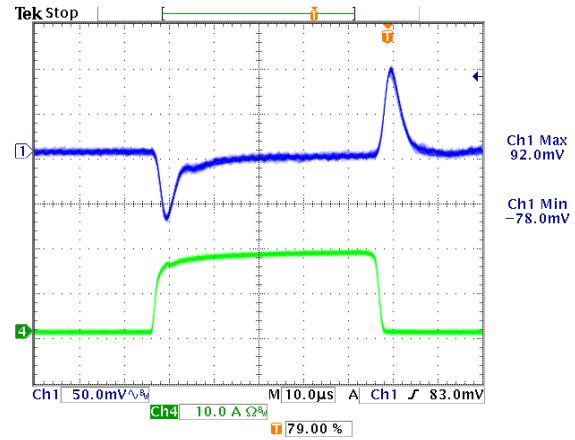

Figure 20: Typical transient response, 1.5V output
CH1:Vo, Ch4:I_o,10A/div

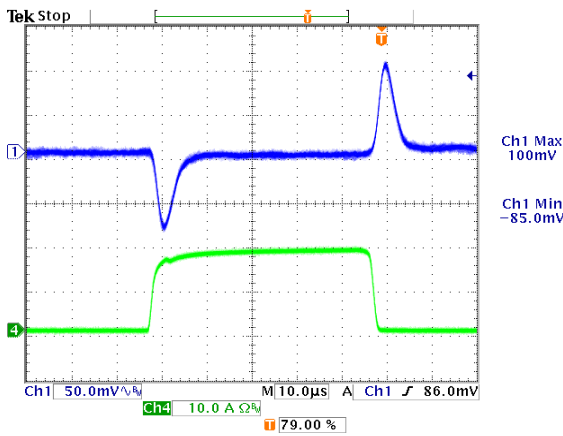

Figure 21: Typical transient response, 1.8V output
CH1:Vo, Ch4:I_o,10A/div

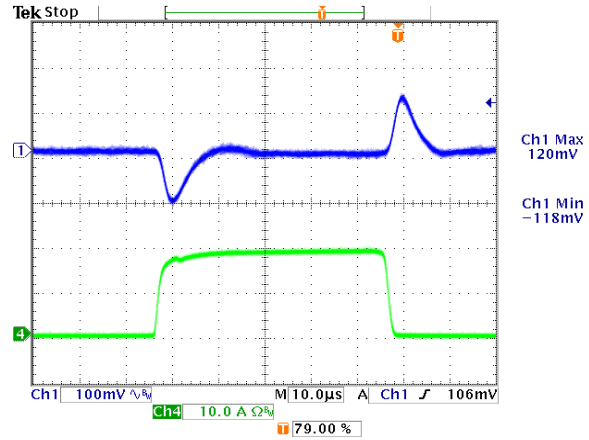

Figure 22: Typical transient response, 2.5V output
CH1:Vo, Ch4:I_o, 10A/div

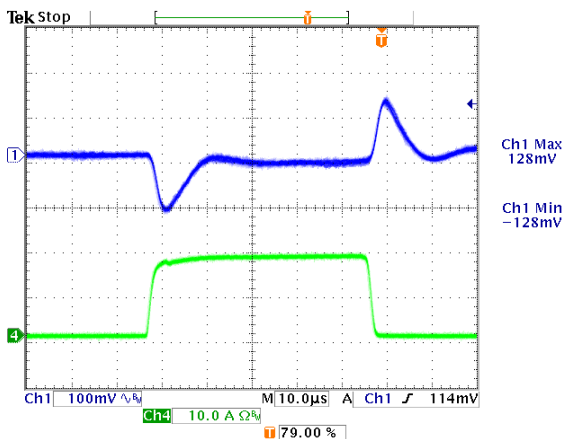

Figure 23: Typical transient response, 3.3V output
CH1:Vo, Ch4:I_o,10A/div

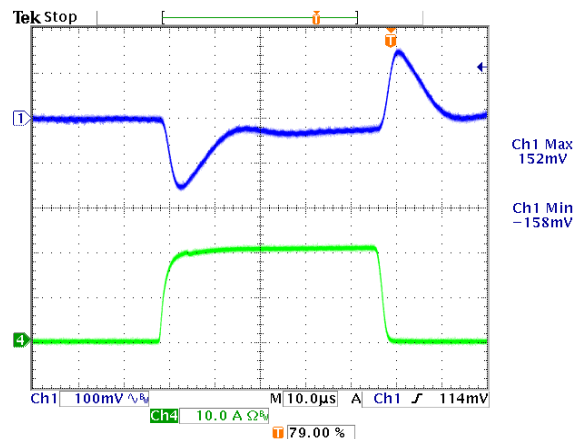

Figure 24: Typical transient response, 5.0V output
CH1:Vo, Ch4:I_o,10A/div

DESIGN CONSIDERATIONS

The D12S400 uses a voltage mode controlled buck topology. The output can be trimmed in the range of 0.8375Vdc to 5.0Vdc by an external resistor from Trim(+) pin to Trim(-).

The converter can be turned ON/OFF by remote control with positive on/off (ENABLE pin) logic. The converter DC output is disabled when the signal is driven low. When this pin is floating the module will turn on.

The converter can protect itself by entering hiccup mode against over current and short circuit condition. Also, the converter will shut down when an over voltage protection is detected.

Safety Considerations

It is recommended that the user to provide a very fast-acting type fuse in the input line for safety. The output voltage set point and the output current in the application could define the amperage rating of the fuse.

FEATURES DESCRIPTIONS

Enable (On/Off)

D12S400 has positive on/off logic, pulling the pin low will turn off the unit. With the active high function, the output is guaranteed to turn on if the ENABLE pin is driven above 4.5V. The output will turn off if the ENABLE pin voltage is pulled below 0.5V. The D12S400 is turned on if the ENABLE pin is floating.

The ENABLE input can be driven in a variety of way as shown in Figures 25.

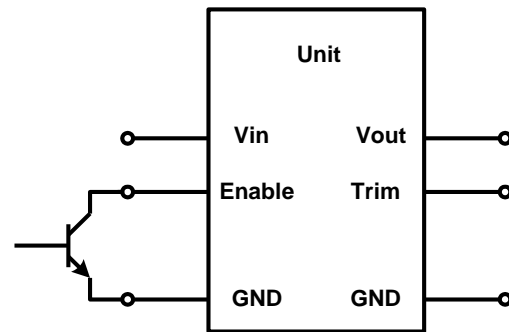

Figure 25: Enable Input drive circuit

Over-Current and Short-Circuit Protection

The D12S400 has non-latching over-current and short circuit protection circuitry. When over current condition occurs, the module goes into the non-latching hiccup mode. When the over-current condition is removed, the module will resume normal operation.

An over current condition is detected by measuring the voltage drop across the $R_{ds(on)}$ of low side MOSFET. $R_{ds(on)}$ is affected by temperature, therefore ambient temperature will affect the current limit inception point.

Output Over Voltage Protection (OVP)

The converter will shut down when an output over voltage protection is detected. Once the OVP condition is detected, controller will latch off and can only reset by input voltage or ON/OFF.

FEATURES DESCRIPTIONS (CONT.)

Output Voltage Programming

The output voltage of the D12S400 is trimmable by connecting an external resistor between the Trim(+) and Trim(-) pins as shown in Figure 26 and the typical trim resistor values are shown in Table 1.

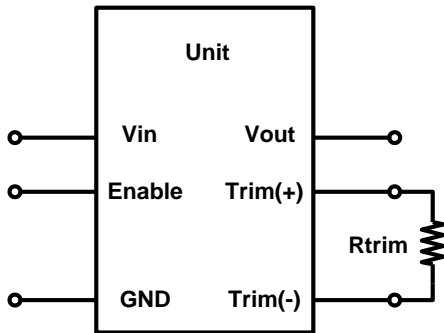

Figure 26: Trimming Output Voltage

The D12S400 module has a trim range of 0.8375V to 5.0V. The trim resistor equation for the D12S400 is:

$$R_{trim}(\Omega) = \frac{1.675}{V_{out} - 0.8375}$$

V_{out} is the output voltage set point
 R_{trim} is the resistance between Trim(+) and Trim(-)
 R_{trim} values should not be less than 360 Ω

Output Voltage	R_{trim} (Ω)
0.8375V	open
+1.0V	10.3K
+1.2V	4.631K
+1.5V	2.528K
+1.8V	1.74K
+2.5V	1.008K
+3.3V	680
+5.0V	402

Table 1: Typical trim resistor values

Power Good

The converter provides an open collector signal called Power Good. This output pin uses positive logic and is open-drain. This power good output is able to sink 4mA.

The power good signal is pulled low when an input under voltage, output over voltage, or output over current conditions is detected or when the converter is disabled by ENABLE pin.

Paralleling

D12S400 converters do not have built-in current sharing (paralleling) ability. Hence, paralleling of multiple D12S400 converters are not recommended.

Output Capacitance

There is output capacitor on the D12S400. Hence, no external output capacitor is required for stable operation.

Reflected Ripple Current and Output Ripple and Noise Measurement

The measurement set-up outlined in Figure 27 has been used for both input reflected/ terminal ripple current and output voltage ripple and noise measurements on D12S400 converters.

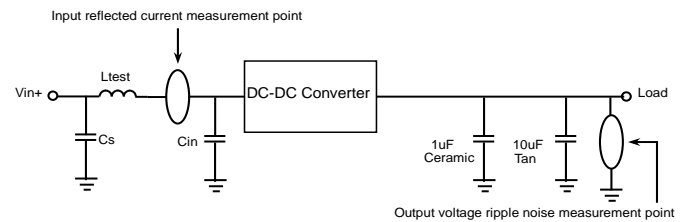

$C_s=330\mu\text{F}$ OS-CON cap x 1, $L_{test}=1\mu\text{H}$, $C_{in}=330\mu\text{F}$ OS-CON cap x 1,

Figure 27: Input reflected ripple/ capacitor ripple current and output voltage ripple and noise measurement setup for D12S400



THERMAL CONSIDERATIONS

Thermal management is an important part of the system design. To ensure proper, reliable operation, sufficient cooling of the power module is needed over the entire temperature range of the module. Convection cooling is usually the dominant mode of heat transfer.

Hence, the choice of equipment to characterize the thermal performance of the power module is a wind tunnel.

Thermal De-rating

Heat can be removed by increasing airflow over the module. The module's maximum hot spot temperature is defined at 125°C. To enhance system reliability, the power module should always be operated below the maximum operating temperature. If the temperature exceeds the maximum module temperature, reliability of the unit may be affected.

THERMAL CURVES (VERTICAL VERSION)

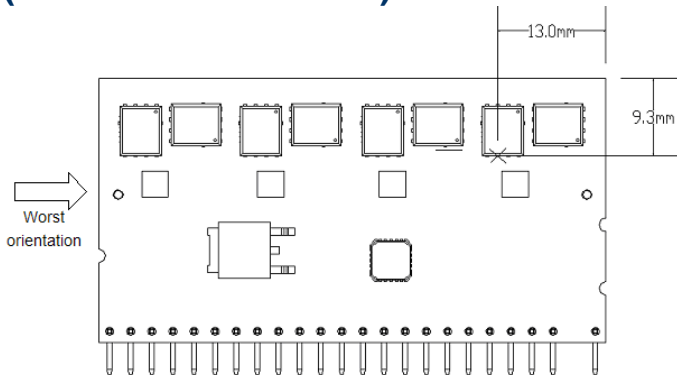

Figure 28: Hot spot temperature measured point

※ The allowed maximum hot spot temperature is defined at 125°C.

THERMAL CURVES (VERTICAL VERSION)

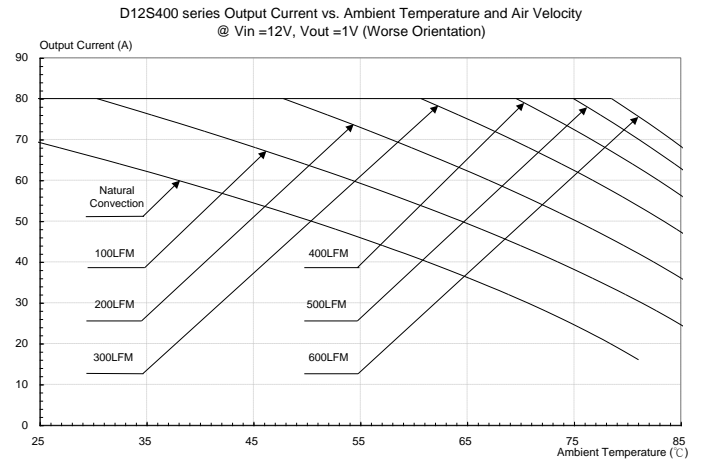

Figure 29: Output current vs. ambient temperature and air velocity @ Vin=12V, Vout=1.0V (Worst Orientation)

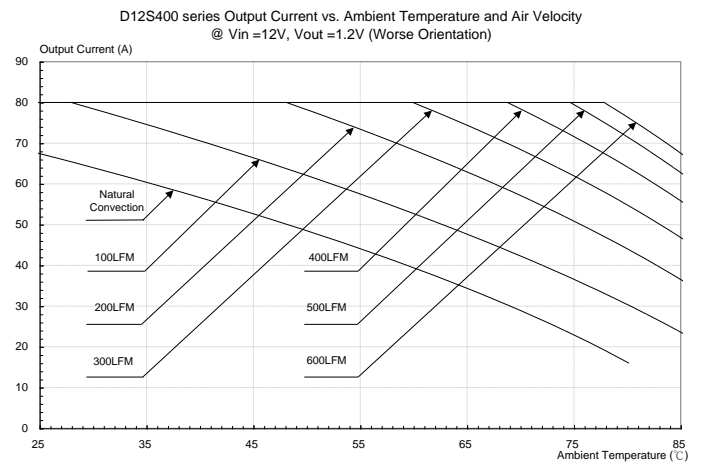

Figure 30: Output current vs. ambient temperature and air velocity @ Vin=12V, Vout=1.2V (Worst Orientation)

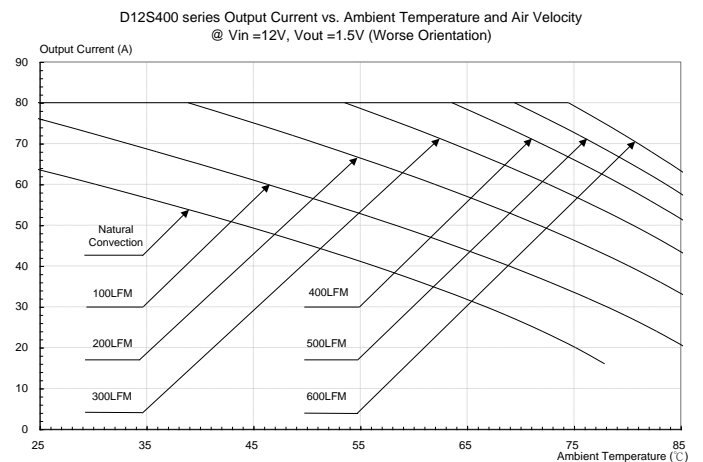

Figure 31: Output current vs. ambient temperature and air velocity @ Vin=12V, Vout=1.5V (Worst Orientation)

THERMAL CURVES (VERTICAL VERSION)

D12S400 series Output Current vs. Ambient Temperature and Air Velocity
@ Vin =12V, Vout =1.8V (Worse Orientation)

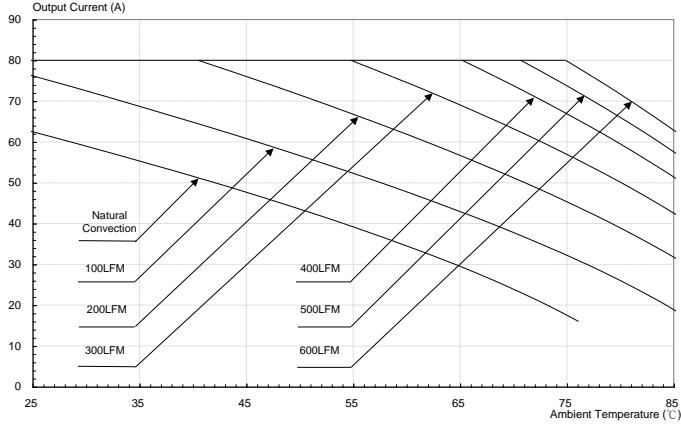

Figure 32: Output current vs. ambient temperature and air velocity @ Vin=12V, Vout=1.8V (Worst Orientation)

D12S400 series Output Current vs. Ambient Temperature and Air Velocity
@ Vin =12V, Vout =3.3V (Worse Orientation)

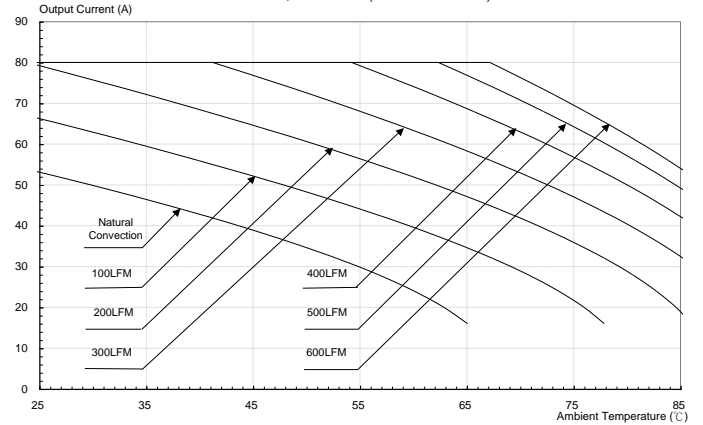

Figure 34: Output current vs. ambient temperature and air velocity @ Vin=12V, Vout=3.3V (Worst Orientation)

D12S400 series Output Current vs. Ambient Temperature and Air Velocity
@ Vin =12V, Vout =2.5V (Worse Orientation)

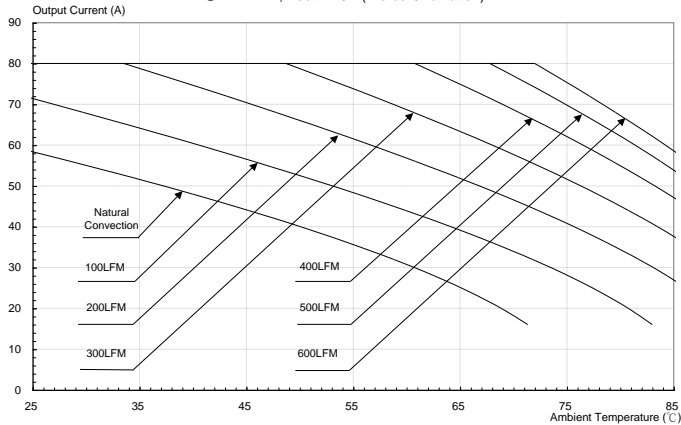

Figure 33: Output current vs. ambient temperature and air velocity @ Vin=12V, Vout=2.5V (Worst Orientation)

D12S400 series Output Current vs. Ambient Temperature and Air Velocity
@ Vin =12V, Vout =5V (Worse Orientation)

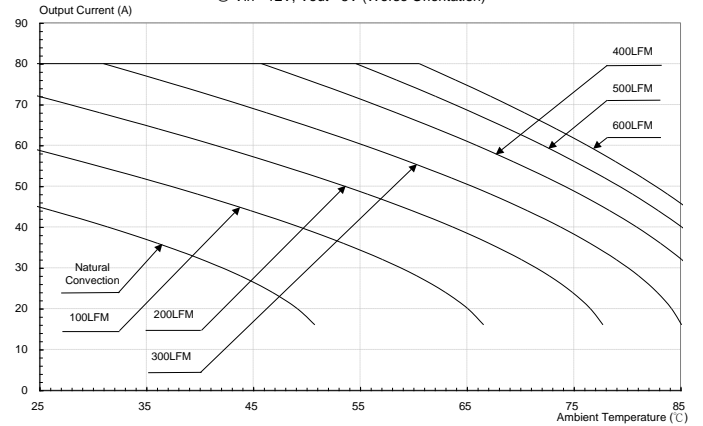
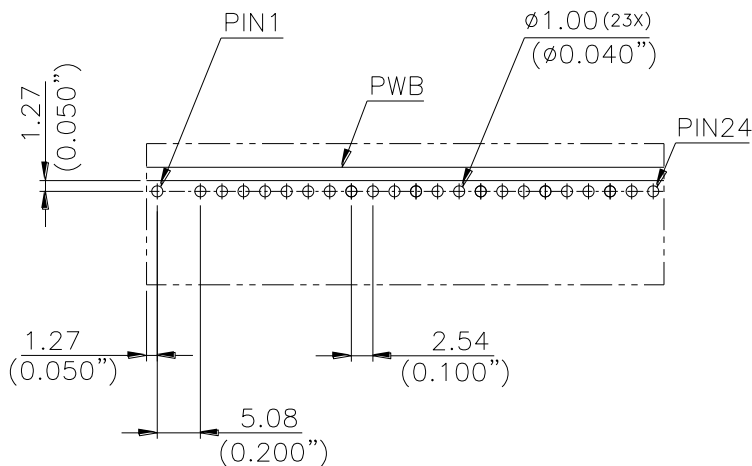
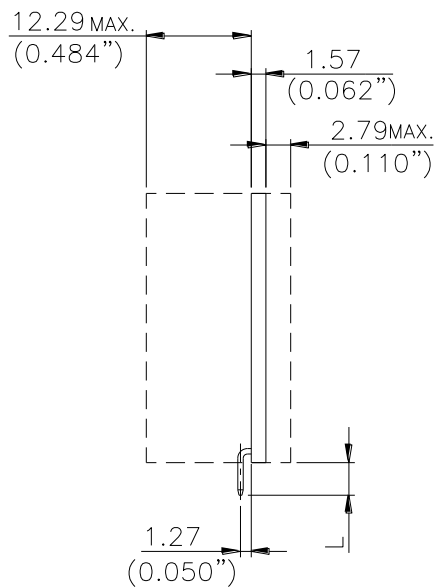
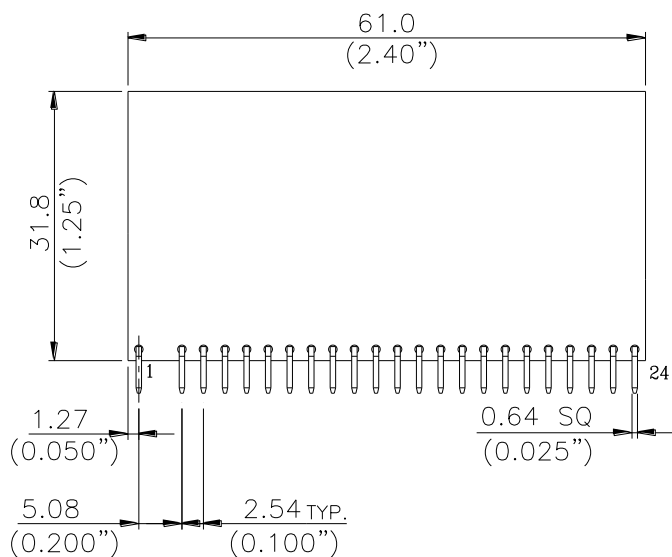

Figure 35: Output current vs. ambient temperature and air velocity @ Vin=12V, Vout=5.0V (Worst Orientation)

MECHANICAL DRAWING



RECOMMENDED P.W.B LAYOUT

Part Number	Pin Length L
D12S400 A	3.5(0.14")
D12S400 B	6.3(0.25")

PIN#	Function	PIN#	Function
1	TRIM +	13	Vin
2	OMIT (KEY)	14	Vin
3	GROUND	15	Vout
4	POWER GOOD	16	Vout
5	TRIM -	17	GROUND
6	NC	18	Vout
7	GROUND	19	GROUND
8	GROUND	20	Vout
9	ENABLE	21	GROUND
10	REM SENSE (-)	22	Vout
11	REM SENSE (+)	23	GROUND
12	Vin	24	Vout

NOTES:

DIMENSIONS ARE IN MILLIMETERS AND (INCHES)
 TOLERANCES: X.Xmm±0.50mm(X.XX in.±0.020 in.)
 X.XXmm±0.25mm(X.XXX in.±0.010 in.)

* All pins are copper with mate tin

PART NUMBERING SYSTEM

D	12	S	400	A
Type of Product	Input Voltage	Number of Outputs	Product Series	Option Code
D - DC/DC modules	12- 10.8 ~13.2V	S- Single	400 - 400W (80A, wide output trim)	A - RoHS 6/6 lead free, positive on/off logic, 3.56mm pin length, Vertical B - RoHS 6/6 lead free, positive on/off logic, 6.35mm pin length, Vertical

MODEL LIST

Model Name	Input Voltage	Output Voltage	Output Current	Pin Length	RoHS 6/6 complaint	Efficiency 12Vin, 5Vout @ 100% load
D12S400 A	10.8 ~ 13.2Vdc	0.8375V ~ 5.0V	80A	3.5mm (0.14")	Yes	94.0%
D12S400 B	10.8 ~ 13.2Vdc	0.8375V ~ 5.0V	80A	6.3mm (0.25")	Yes	94.0%

CONTACT: www.deltaww.com/dcdc

USA:

Telephone:
East Coast: 978-656-3993
West Coast: 510-668-5100
Fax: (978) 656 3964
Email: DCDC@delta-corp.com

Europe:

Telephone: +31-20-655-0967
Fax: +31-20-655-0999
Email: DCDC@delta-es.com

Asia & the rest of world:

Telephone: +886 3 4526107 ext. 6220~6224
Fax: +886 3 4513485
Email: DCDC@delta.com.tw

WARRANTY

Delta offers a two (2) year limited warranty. Complete warranty information is listed on our web site or is available upon request from Delta.

Information furnished by Delta is believed to be accurate and reliable. However, no responsibility is assumed by Delta for its use, nor for any infringements of patents or other rights of third parties, which may result from its use. No license is granted by implication or otherwise under any patent or patent rights of Delta. Delta reserves the right to revise these specifications at any time, without notice.