

Slotted Optical Switch

OPB820, OPB821Z, OPB821S__Z



Features:

- Non-contact switching
- Four standard aperture sizes for high resolution
- Low profile
- 0.080" (2.03 mm) wide, 0.250" (8.89 mm) deep slot
- Choice of PCBoard or wire mountings

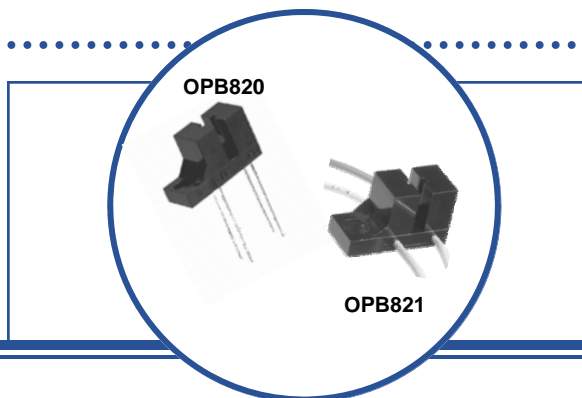

Description:

Each **OPB820** and **OPB821** device consists of an infrared emitting diode (LED, 890 nm center wavelength) and a NPN silicon phototransistor mounted in a low-cost black plastic housing on opposite sides of an 0.080" (2.03 mm) wide slot. Each device in this series has a 0.040" (1.02 mm) wide aperture located in front of the infrared diode. Phototransistor switching occurs when an opaque object passes through the slot.

Devices are offered with 0.275" (6.96 mm) lead spacing for PCBoard mounting (**OPB820**) or 24" (610 mm) 26 AWG wire leads (**OPB821**).

Custom electrical, wire and cabling and connectors are available. Contact your local representative or OPTEK for more information.

Applications:

- Non-contact object sensing
- Assembly line automation
- Machine automation
- Equipment safety
- Machine safety

Ordering Information							
Part Number	LED Peak Wavelength	Sensor	Slot Width / Depth	Aperture Emitter/Sensor	Lead Length / Spacing		
OPB820	890 nm	Transistor	0.080" / 0.255"	0.04"/ 0.04"	0.425" / 0.275"		
OPB820S10				0.04"/ 0.01"			
OPB820S5				0.04"/ 0.005"			
OPB820S3				0.04"/ 0.003"			
OPB821Z						0.040"/ 0.040"	24"/26 AWG Wire
OPB821S10Z						0.040"/ 0.010"	
OPB821S5Z						0.040"/ 0.005"	
OPB821S3Z						0.040"/ 0.003"	



RoHS

OPTEK reserves the right to make changes at any time in order to improve design and to supply the best product possible.

Package Drawing
OPB820

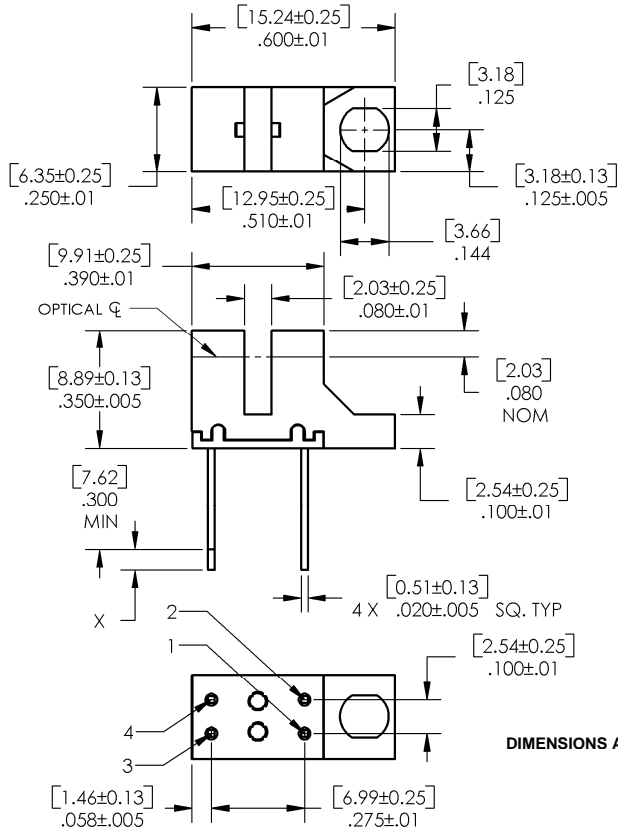

Package Drawing
OPB821

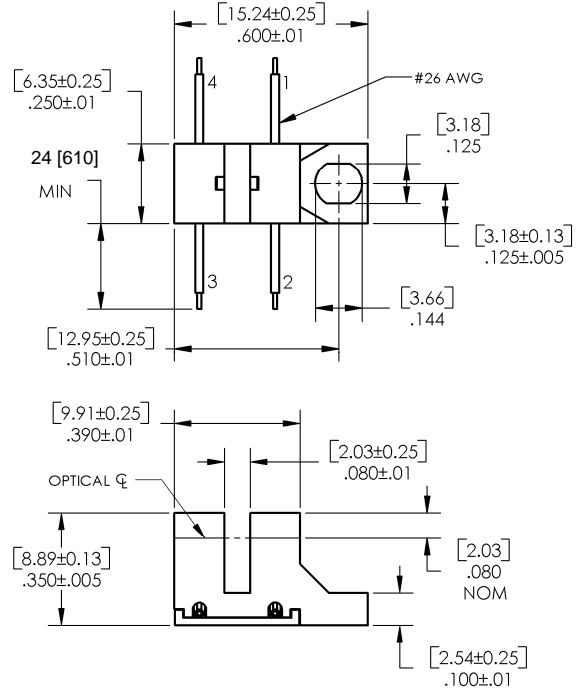

DIMENSIONS ARE IN: [MILLIMETERS]
 INCHES

Pin #	Description	Pin #	Description
4	Cathode	2	Collector
3	Anode	1	Emitter

Color/Pin #	Description	Color/Pin #	Description
Green-3	Cathode	White-2	Collector
Orange-4	Anode	Blue-1	Emitter

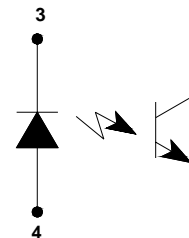
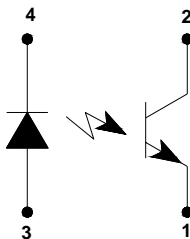

CONTAINS POLYSULFONE
 To avoid stress cracking, we suggest using ND Industries' **Vibra-Tite** for thread-locking. **Vibra-Tite** evaporates fast without causing structural failure in OPTEK's molded plastics.

OPTEK reserves the right to make changes at any time in order to improve design and to supply the best product possible.

Absolute Maximum Ratings ($T_A=25^{\circ}\text{C}$ unless otherwise noted)

Storage and Operating Temperature	-40°C to +85°C
Lead Soldering Temperature (1/16 inch [1.6 mm] from case for 5 seconds with soldering iron) ⁽¹⁾	260°C

Input Diode

Continuous Forward Current	50 mA
Peak Forward Current (1µs pulse width, 300 pps)	3 A
Reverse Voltage	2 V
Power Dissipation ⁽²⁾	100 mW

Output Phototransistor

Collector-Emitter Voltage	30 V
Emitter-Collector Voltage	5 V
Power Dissipation ⁽²⁾	100 mW

Notes:

- (1) RMA flux is recommended. Duration can be extended to 10 seconds maximum when flow soldering.
- (2) For OPB820, derate linearly 1.67 mW/° C above 25° C. For OPB821, derate linearly 1.82 mW/° C above 25° C.
- (3) Methanol or isopropanol are recommended as cleaning agents. Plastic housing is soluble in chlorinated hydrocarbons and ketones.
- (4) All parameters were tested using pulse technique.

Electrical Characteristics ($T_A = 25^{\circ}\text{C}$ unless otherwise noted)

SYMBOL	PARAMETER	MIN	TYP	MAX	UNITS	TEST CONDITIONS
--------	-----------	-----	-----	-----	-------	-----------------

Input Diode (See OP245 for additional information)

V_F	Forward Voltage	-	-	1.7	V	$I_F = 20 \text{ mA}$
I_R	Reverse Current	-	-	100	µA	$V_R = 2 \text{ V}$

Output Phototransistor (See OP555 for additional information)

$V_{(BR)CEO}$	Collector-Emitter Breakdown Voltage	30	-	-	V	$I_C = 1 \text{ mA}$
$V_{(BR)ECO}$	Emitter-Collector Breakdown Voltage	5	-	-	V	$I_E = 100 \text{ µA}$
I_{CEO}	Collector-Emitter Dark Current	-	-	100	nA	$V_{CE} = 10 \text{ V}, I_F = 0, I_E = 0$

Coupled

$V_{CE(SAT)}$	Collector-Emitter Saturation Voltage					
	OPB820, OPB821	-	-	0.4	V	$I_C = 250 \text{ µA}, I_F = 20 \text{ mA}$
	OPB820S3, OPB821S3	-	-	0.4	V	$I_C = 40 \text{ µA}, I_F = 20 \text{ mA}$
	OPB820S5, OPB821S5	-	-	0.4	V	$I_C = 125 \text{ µA}, I_F = 20 \text{ mA}$
	OPB820S10, OPB821S10	-	-	0.4	V	$I_C = 250 \text{ µA}, I_F = 20 \text{ mA}$
$I_{C(ON)}$	On-State Collector Current					
	OPB820, OPB821	500	-	-	µA	$V_{CE} = 5 \text{ V}, I_F = 10 \text{ mA}$
	OPB820S3, OPB821S3	60	-	-	µA	$V_{CE} = 5 \text{ V}, I_F = 10 \text{ mA}$
	OPB820S5, OPB821S5	300	-	-	µA	$V_{CE} = 5 \text{ V}, I_F = 10 \text{ mA}$
	OPB820S10, OPB821S10	400	-	-	µA	$V_{CE} = 5 \text{ V}, I_F = 10 \text{ mA}$

OPTEK reserves the right to make changes at any time in order to improve design and to supply the best product possible.

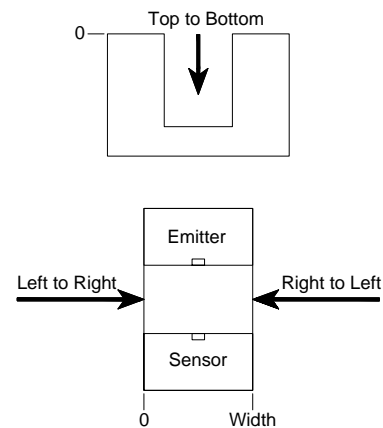
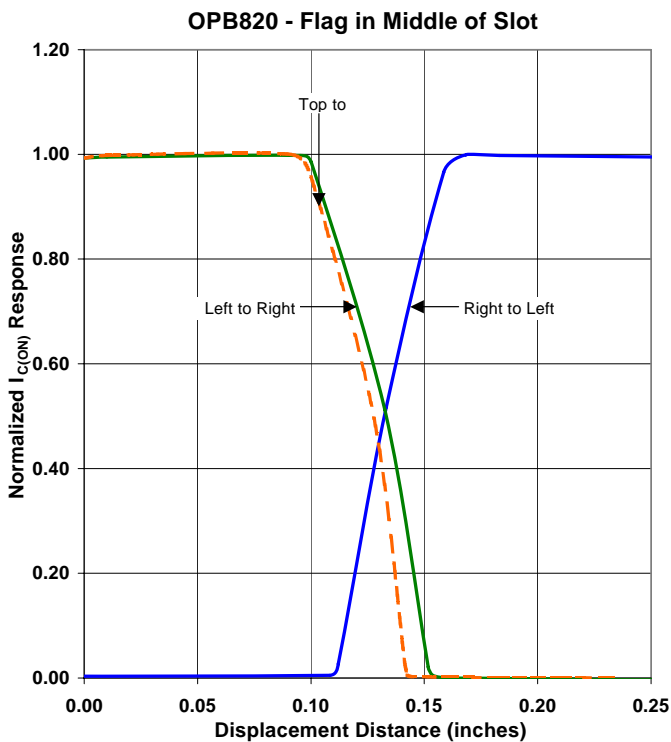
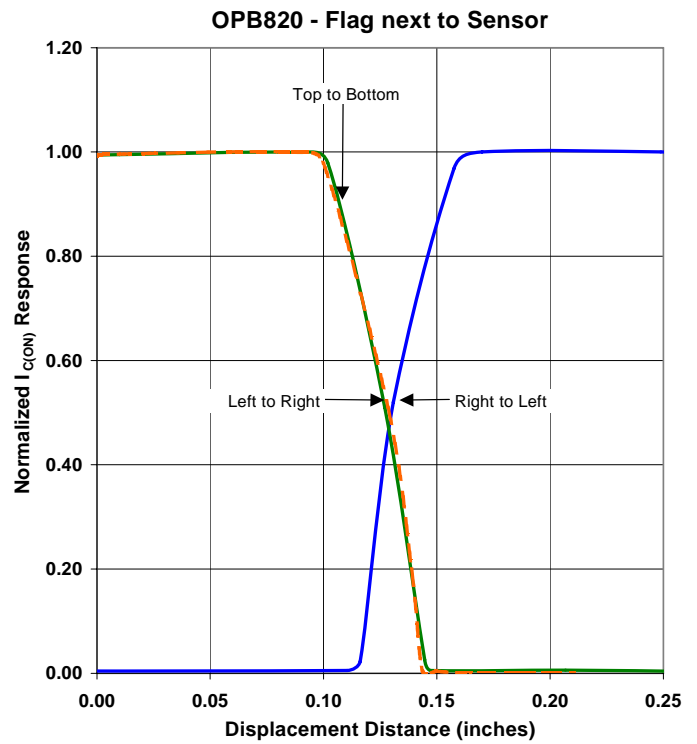
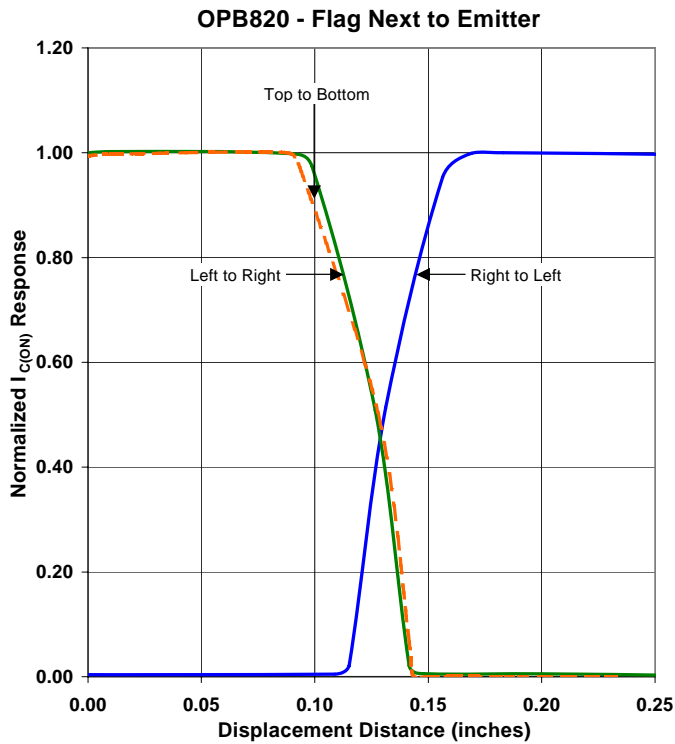

OPTEK reserves the right to make changes at any time in order to improve design and to supply the best product possible.

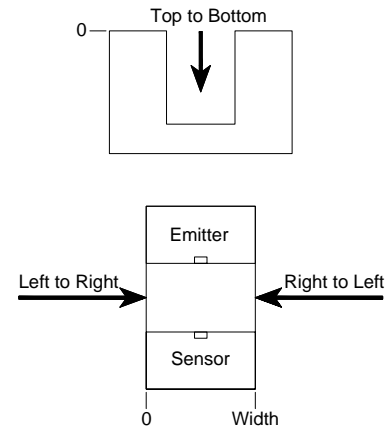
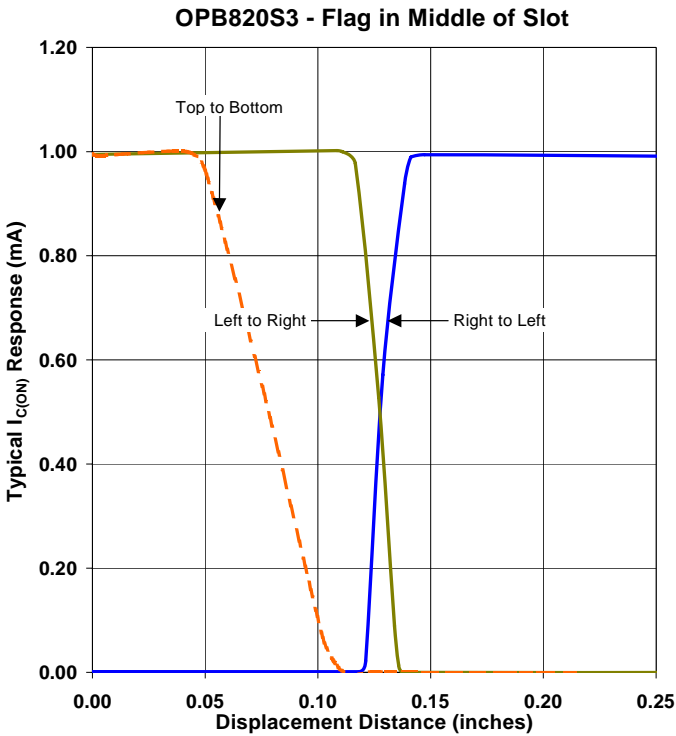
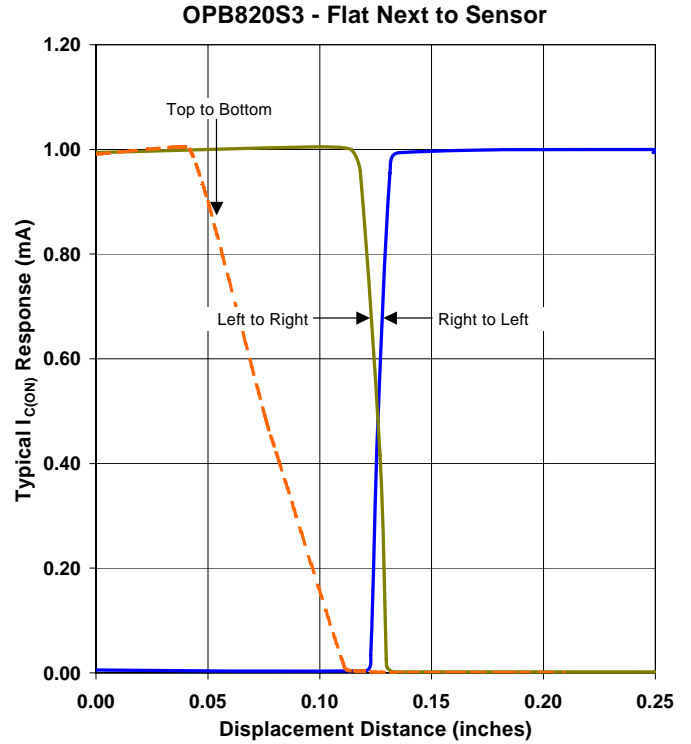
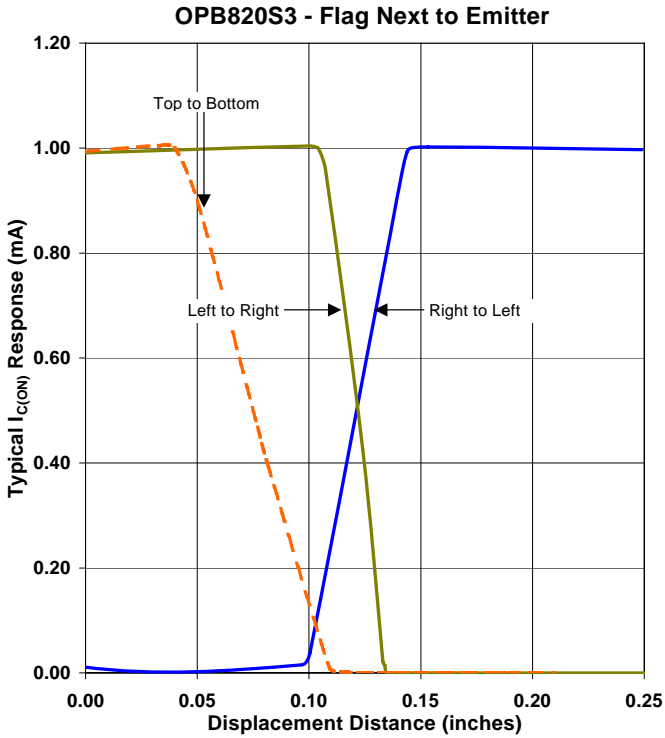

OPTEK reserves the right to make changes at any time in order to improve design and to supply the best product possible.

OPB820S5 - Flag Next to Emitter

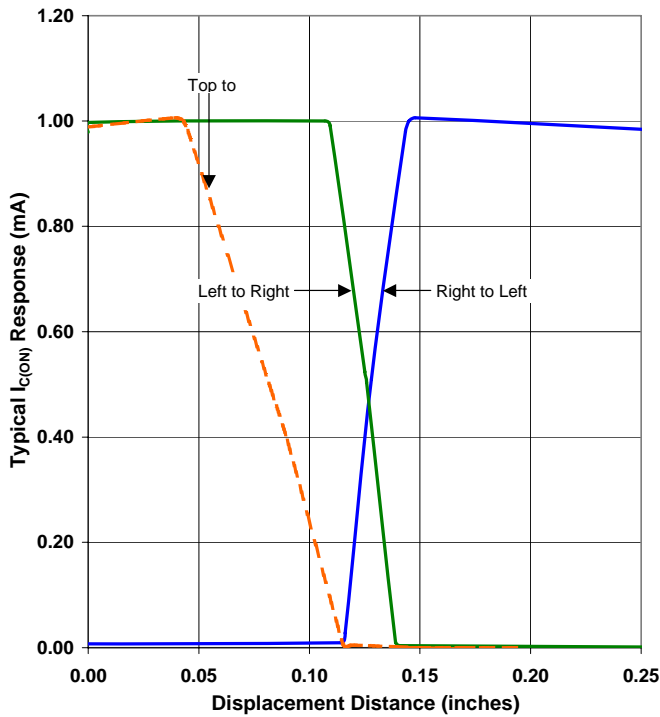

OPB820S5 - Flag Next to Sensor

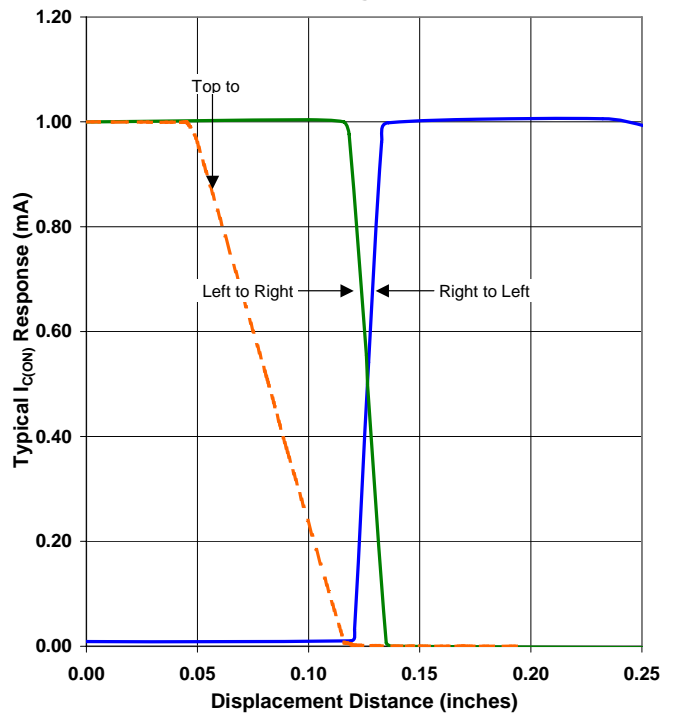

OPB820S5 - Flag in Middle Slot

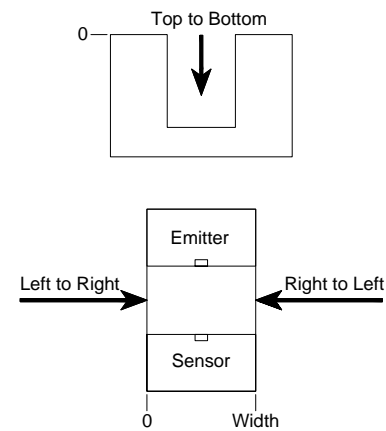
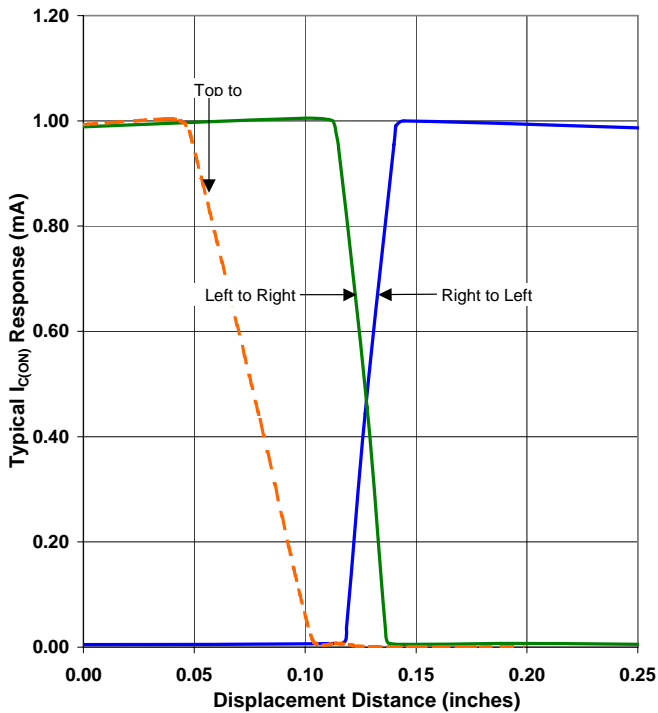

OPTEK reserves the right to make changes at any time in order to improve design and to supply the best product possible.

OPB820S10 - Flag Next to Emitter

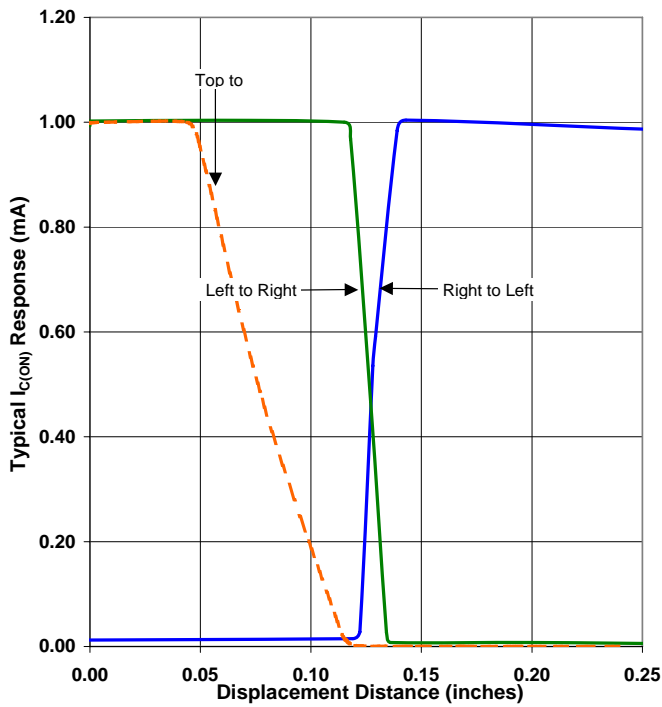

OPB820S10 - Flag Next to Sensor

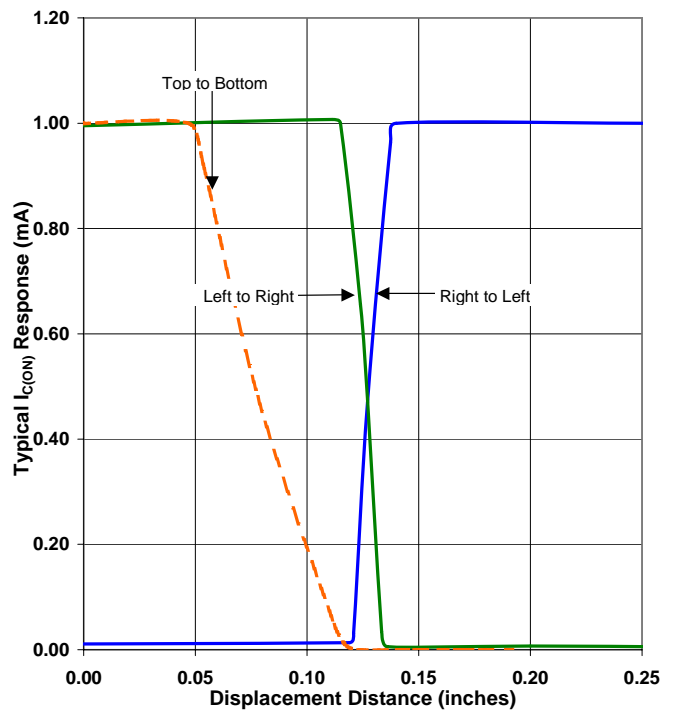

OPB820S10 - Flag in Middle of Slot

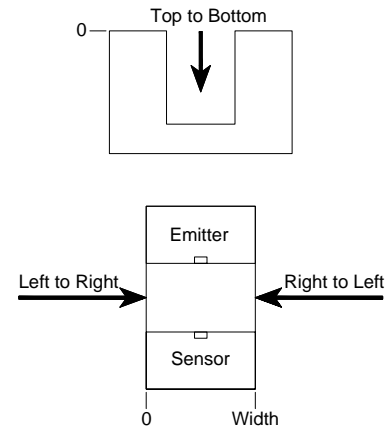
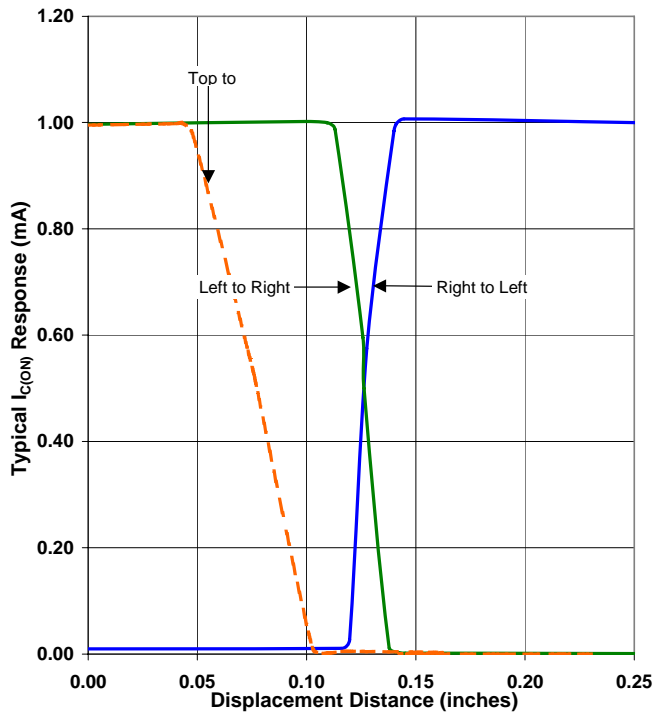

OPTEK reserves the right to make changes at any time in order to improve design and to supply the best product possible.