

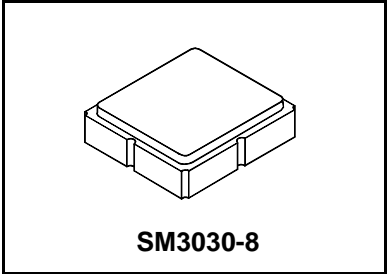

SF2032E

1220 MHz SAW Filter



- SAW Filter for Digital Television
- Complies with Directive 2002/95/EC (RoHS)

Characteristics :

Balance to Balanced operation
 Terminating source impedance : $Z_S = 200 \Omega$
 Terminating load impedance : $Z_L = 200 \Omega$

Maximum Rating

Rating	Value	Units
Input Power Level	0	dB _m
DC Voltage	3	V
Operating Temperature	-30 ~ +85	°C
Storage Temperature	-40 ~ +85	°C

Electrical Characteristics

Characteristic	Sym	Notes	Min	Typ	Max	Units
Center Frequency	f _C			1220		MHz
Insertion Loss (1206~1234 MHz)	IL			4.0	5.7	dB
Amplitude Ripple (1206~1234 MHz)				1.9	3.5	dB
Attenuation: (Reference level from 0 dB)						
1) 300 ~ 1118 MHz			40	59		dB
2) 1118 ~ 1146 MHz			45	60		
3) 1300 ~ 2000 MHz			45	59		
Group delay Ripple (p-p)				15		ns

Case Style	SM3030-8 3.0 x 3.0 mm Nominal Footprint	
Lid Symbolization (Y=year, WW=week, S=shift) dot=pin 1 indicator	504, YWWS	
Standard Reel Quantity	Reel Size 7 Inch	1000 Pieces/Reel
	Reel Size 13 Inch	3000 Pieces/Reel

Notes:

1. US and international patents may apply.
2. RFM, stylized RFM logo, and RF Monolithics, Inc. are registered trademarks of RF Monolithics, Inc.
3. ©Copyright 1999, RF Monolithics Inc.
4. Electrostatic Sensitive Device. Observe precautions for handling.



D. Transfer Function :

Narrowband

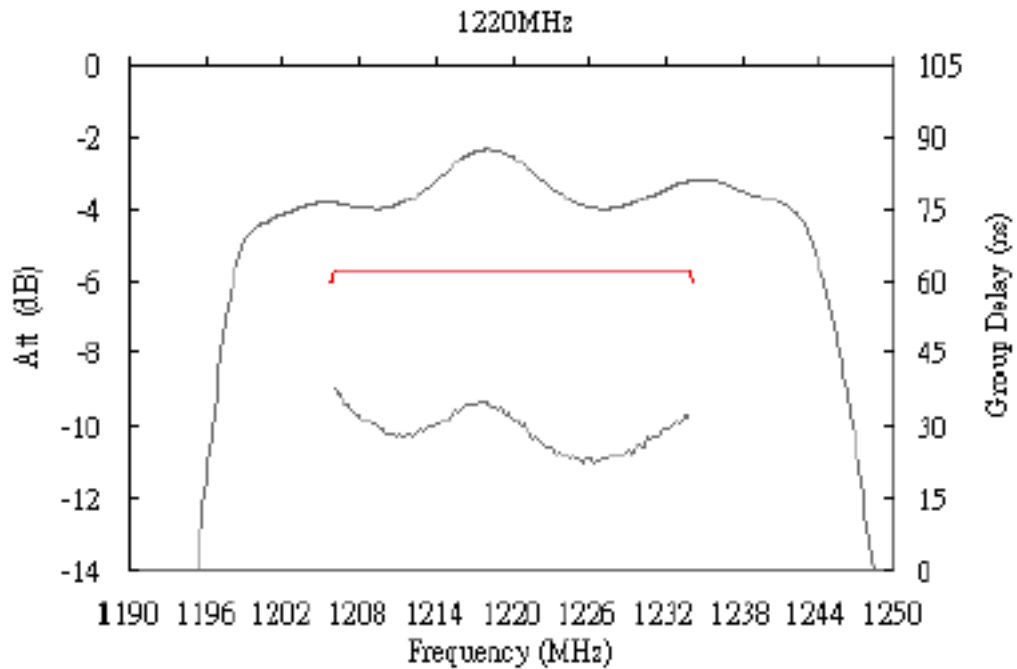
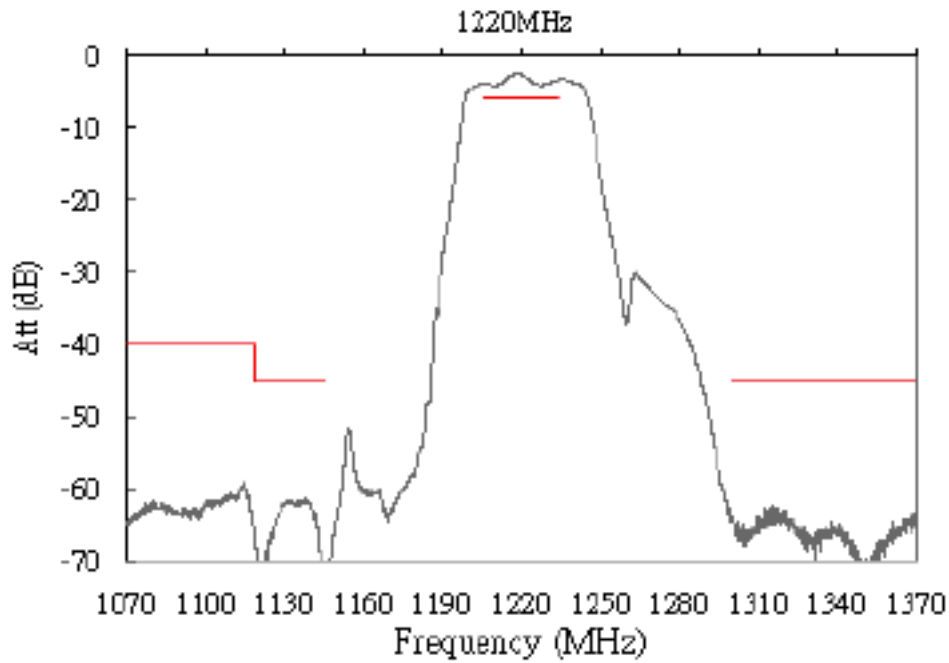

Wideband

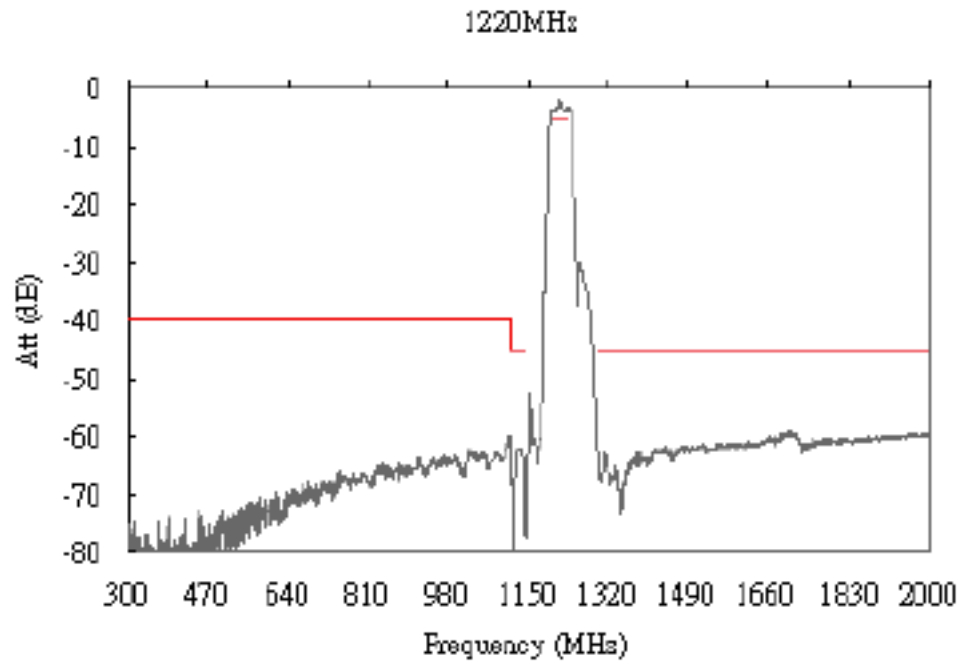

MEASUREMENT CIRCUIT:

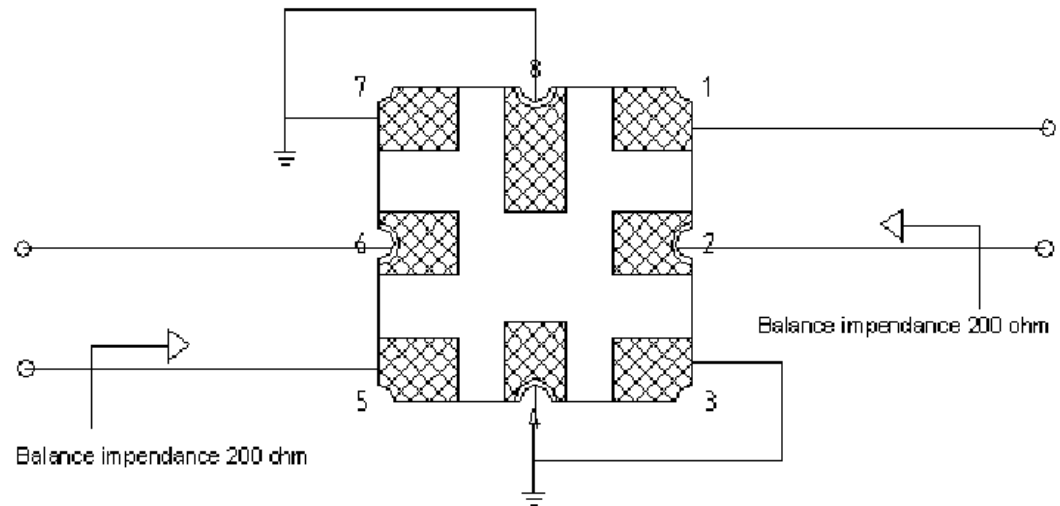

Tape and Reel Specifications

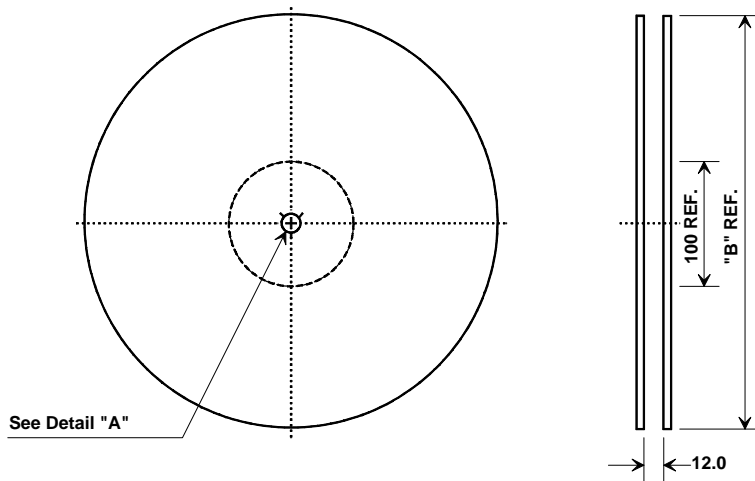

"B"		Quantity Per Reel
Inches	millimeters	
7	178	1000
13	330	3000

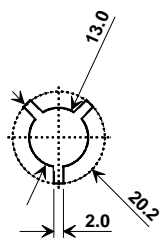

COMPONENT ORIENTATION and DIMENSIONS

Carrier Tape Dimensions	
Ao	3.35 mm
Bo	3.35 mm
Ko	1.4 mm
Pitch	8.0 mm
W	12.0 mm

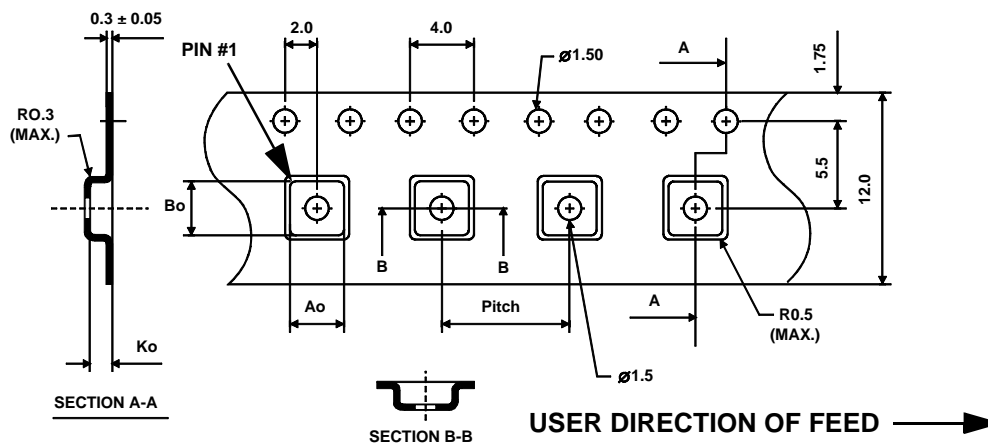

**8-Terminal Ceramic Surface-Mount Case
3.0 X 3.0 mm Nominal Footprint**

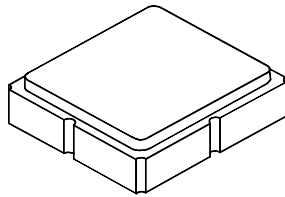

Case Dimensions

Dimension	mm			Inches		
	Min	Nom	Max	Min	Nom	Max
A		3.0				
B		3.0				
C			1.40			
D						
E		0.75				
F		0.60				
G		0.60				
H		1.20				

Electrical Connections

	Connection	Terminals
	Balanced Input	1, 2
	Balanced Output	5, 6
	Ground	All Others

Dot Indicates Pin 1

TOP VIEW

BOTTOM VIEW

