

97 mm

San Ace B97

33mm thick



General Specifications

- Material Frame: Plastics (Flammability: UL94V-0),
Impeller: Plastics (Flammability: UL94V-0)
- Expected Life Refer to specifications (L10:Survival rate: 90% at 60°C ,
rated voltage, and continuously run in a free air state)
- Lead Wire ⊕red ⊖black (Sensor) yellow
- Storage Temperature -30°C to +70°C (Non-condensing)

97 mm × 33 mm (Mass : 175g)

Specifications

 The following nos. **have pulse sensors.**

Model No.	Rated Voltage [V]	Operating Voltage Range [V]	Rated Current [A]	Rated Input [W]	Rated Speed [min ⁻¹]	Max. Air Flow [m ³ /min] [CFM]	Max. Static Pressure [Pa] [inchH ₂ O]	SPL [dB(A)]	Operating Temperature [°C]	Expected Life ^{Typ} [h]
109BM12GC2-1	12	7 to 13.8	0.60	7.20	3,800	0.82 28.9	281 1.129	51.5	-20 to +70	40,000/60°C (70,000/40°C)
109BM12HC2-1			0.40	4.80	3,300	0.71 25.1	204 0.819	48.5		
109BM12MC2-1			0.26	3.12	2,700	0.58 20.5	119 0.478	43.5		
109BM24GC2-1	24	12 to 27.6	0.31	7.44	3,800	0.82 28.9	281 1.129	51.5		
109BM24HC2-1			0.26	6.24	3,300	0.71 25.1	204 0.819	48.5		
109BM24MC2-1			0.15	3.60	2,700	0.58 20.5	119 0.478	43.5		

Note: Expected life at 40°C ambient is just reference value.

- Available options: ⇒ **Without Sensor** **Lock Sensor**

Dimensions (Unit : mm)

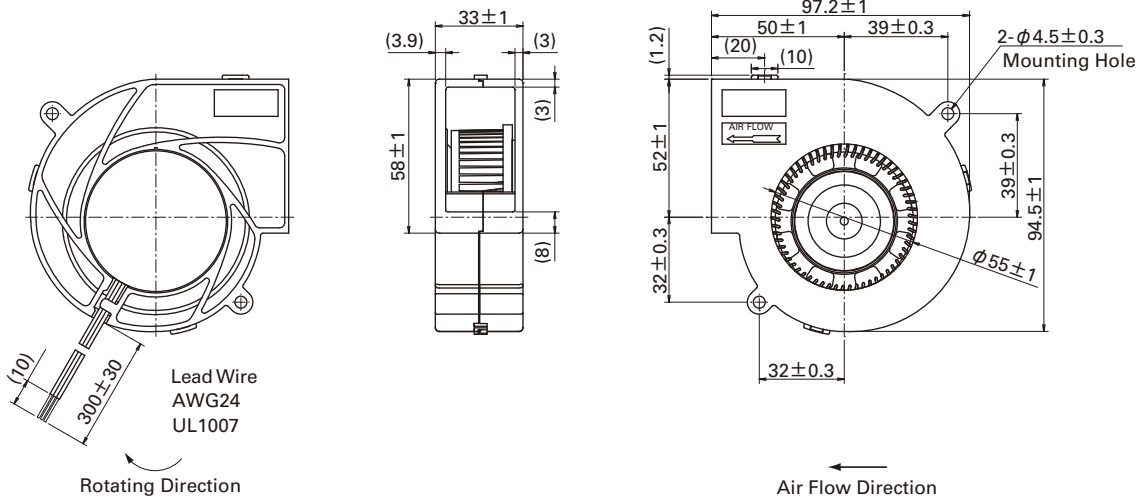

Air Flow - Static Pressure Characteristics

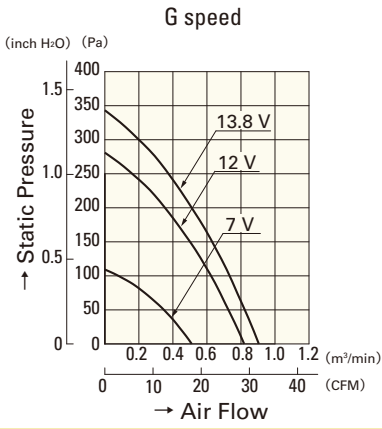

109BM12GC2-1

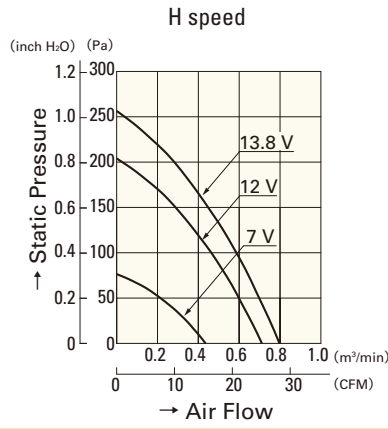

109BM12HC2-1

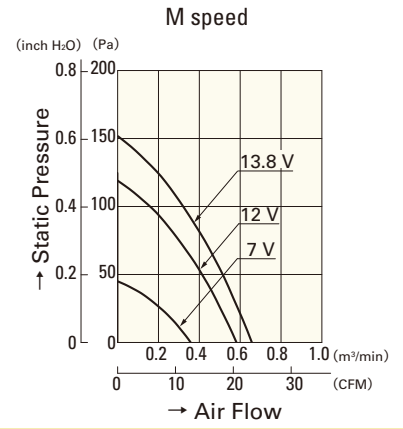

109BM12MC2-1

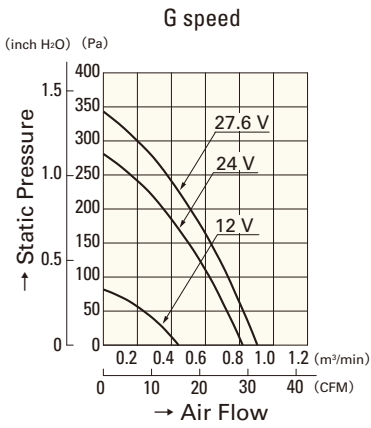

109BM24GC2-1

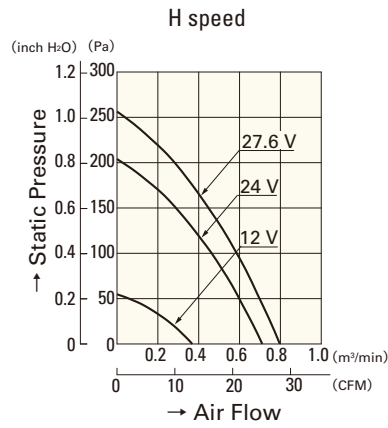

109BM24HC2-1

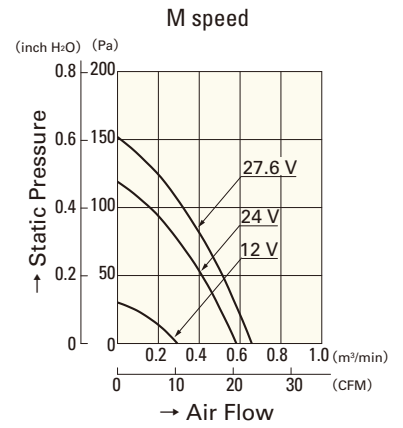

109BM24MC2-1

Blower 97mm