



■ General Description

The AME8804 family of positive, linear regulators feature low quiescent current (30µA typ.) with low dropout voltage, making them ideal for battery applications. The space-saving SOT-26 and SOT-25 packages are attractive for "Pocket" and "Hand Held" applications.

These rugged devices have both Thermal Shutdown, and Current Fold-back to prevent device failure under the "Worst" of operating conditions.

The SOT-26 version also features a "Power Good" detector, which pulls low when the output is out of regulation.

The AME8804 is stable with an output capacitance of 2.2µF or greater.

■ Features

- Very Low Dropout Voltage
- Guaranteed 300mA Output
- Accurate to within 1.5%
- 30µA Quiescent Current
- Over-Temperature Shutdown
- Current Limiting
- Short Circuit Current Fold-back
- Power Good Detector (6 pin version only)
- Power-Saving Shutdown Mode
- Space-Saving SOT-26 and SOT-25
- Adjustable Output Voltages
- Low Temperature Coefficient

■ Functional Block Diagram

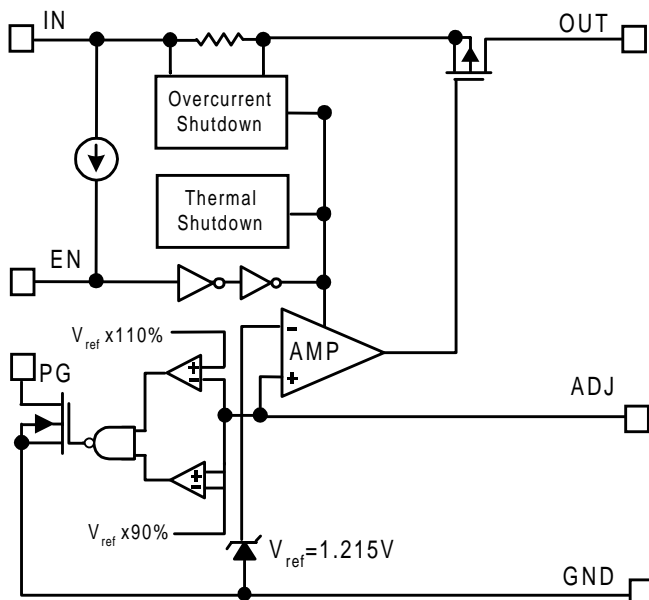

■ Applications

- Instrumentation
- Portable Electronics
- Wireless Devices
- Cordless Phones
- PC Peripherals
- Battery Powered Widgets
- Electronic Scales

■ Typical Application

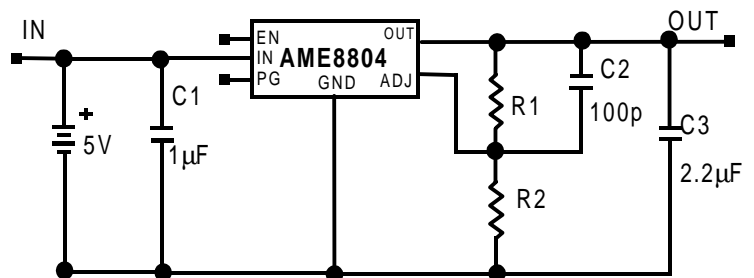

$V_{OUT} = 1.215 (R1 + R2) / R2$
 C2 is unnecessary when R1 or R2 < 20K
 PG pin is only available in the SOT-26 package option



■ Pin Configuration

SOT-26 Top View

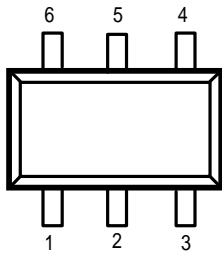

- 1. V_{IN}
- 2. GND
- 3. EN
- 4. PG
- 5. ADJ
- 6. V_{OUT}

SOT-25 Top View

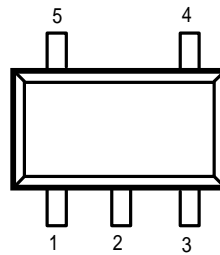

- 1. V_{IN}
- 2. GND
- 3. EN
- 4. ADJ
- 5. V_{OUT}

■ Ordering Information

Part Number	Marking	Output Voltage	Package	Operating Temp. Range
AME8804AEEY	AAUww	Adjustable	SOT-26	-40°C to +85°C
AME8804AEEV	AJCww	Adjustable	SOT-25	-40°C to +85°C

Please consult AME sales office or authorized Rep./Distributor for other package type availability.



■ Absolute Maximum Ratings

Parameter	Maximum	Unit
Input Voltage	8	V
Output Current	$P_D / (V_{IN} - V_O)$	mA
Input, Output Voltage	GND - 0.3 to $V_{IN} + 0.3$	V
ESD Classification	B	

■ Recommended Operating Conditions

Parameter	Rating	Unit
Ambient Temperature Range	- 40 to +85	°C
Junction Temperature	- 40 to +125	°C

■ Thermal Information

Parameter		Maximum	Unit
Thermal Resistance (θ_{ja})	SOT-25	260	°C / W
Internal Power Dissipation (P_D) ($\Delta T = 100^\circ\text{C}$)	SOT-25	380	mW
Thermal Resistance (θ_{ja})	SOT-26	260	°C / W
Internal Power Dissipation (P_D) ($\Delta T = 100^\circ\text{C}$)	SOT-26	380	mW
Maximum Junction Temperature		150	°C
Maximum Lead Temperature (10 Sec)		300	°C

Caution: Stress above the listed absolute rating may cause permanent damage to the device



■ Electrical Specifications

$T_A = 25^\circ\text{C}$ $V_{IN} = 5\text{V}$ unless otherwise noted

Parameter	Symbol	Test Condition	Min	Typ	Max	Units
Input Voltage	V_{IN}		Note 1		7	V
Output Voltage Accuracy	V_O	$I_O = 1\text{mA}$	-1.5		1.5	%
Dropout Voltage	$V_{DROPOUT}$	$I_O = 300\text{mA}$ $V_O = V_{ONOM} - 2.0\%$	$1.5\text{V} < V_{O(NOM)} \leq 2.0\text{V}$	See chart	1300	mV
			$2.0\text{V} < V_{O(NOM)} \leq 2.8\text{V}$		400	
			$2.8\text{V} < V_{O(NOM)} < 3.8\text{V}$		300	
Output Current	I_O	$V_O > 1.2\text{V}$	300			mA
Current Limit	I_{LIM}	$V_O > 1.2\text{V}$	300	450		mA
Short Circuit Current	I_{SC}	$V_O < 0.8\text{V}$		150	300	mA
Quiescent Current	I_Q	$I_O = 0\text{mA}$		30	50	μA
Ground Pin Current	I_{GND}	$I_O = 1\text{mA}$ to 300mA		35		μA
Line Regulation	REG_{LINE}	$I_O = 5\text{mA}$ $V_{IN} = V_O + 1$ to $V_O + 2$	$V_O < 2.0\text{V}$		0.15	%
			$V_O \geq 2.0\text{V}$		0.02	0.1
Load Regulation	REG_{LOAD}	$I_O = 1\text{mA}$ to 300mA		0.2	1	%
Over Temperature Shutdown	OTS			150		$^\circ\text{C}$
Over Temperature Hysteresis	OTH			30		$^\circ\text{C}$
V_O Temperature Coefficient	TC			30		ppm/ $^\circ\text{C}$
Power Supply Rejection	PSRR	$I_O = 100\text{mA}$ $C_O = 2.2\mu\text{F}$	$f = 1\text{kHz}$		50	dB
			$f = 10\text{kHz}$		20	
			$f = 100\text{kHz}$		15	
Output Voltage Noise	eN	$f = 10\text{Hz}$ to 100kHz $I_O = 10\text{mA}$, $C_{BYP} = 0\mu\text{F}$			30	μV_{rms}
ADJ Input Bias Current	I_{ADJ}			1		μA
ADJ Reference Voltage	V_{REF}		1.203	1.215	1.227	V
EN Input Threshold	V_{EH}	$V_{IN} = 2.7\text{V}$ to 7V	2.0		V_{in}	V
	V_{EL}	$V_{IN} = 2.7\text{V}$ to 7V	0		0.4	V
EN Input Bias Current	I_{EH}	$V_{EN} = V_{IN}$, $V_{IN} = 2.7\text{V}$ to 7V			0.1	μA
	I_{EL}	$V_{EN} = 0\text{V}$, $V_{IN} = 2.7\text{V}$ to 7V			0.5	μA
Shutdown Supply Current	I_{SD}	$V_{IN} = 5\text{V}$, $V_O = 0\text{V}$, $V_{EN} < V_{EL}$		0.5	1	μA
Shutdown Output Voltage	$V_{O,SD}$	$I_O = 35\mu\text{A}$, $V_{EN} < V_{EL}$	0		0.1	V
Output Under Voltage	V_{UV}				85	% $V_{O(NOM)}$
Output Over Voltage	V_{OV}		115			% $V_{O(NOM)}$
PG Leakage Current	I_{LC}	$V_{PG} = 7\text{V}$			1	μA
PG Voltage Rating	V_{PG}	V_O in regulation			7	V
PG Voltage Low	V_{OL}	$I_{SINK} = 0.4\text{mA}$			0.4	V

Note1: $V_{IN(min)} = V_{OUT} + V_{DROPOUT}$



■ Detailed Description

The AME8804 family of CMOS regulators contain a PMOS pass transistor, voltage reference, error amplifier, over-current protection, thermal shutdown, and Power Good detection circuitry.

The P-channel pass transistor receives data from the error amplifier, over-current shutdown, and thermal protection circuits. During normal operation, the error amplifier compares the output voltage to a precision reference. Over-current and Thermal shutdown circuits become active when the junction temperature exceeds 150°C, or the current exceeds 300mA. During thermal shutdown, the output voltage remains low. Normal operation is restored when the junction temperature drops below 120°C.

The AME8804 switches from voltage mode to current mode when the load exceeds the rated output current. This prevents over-stress. The AME8804 also incorporates current foldback to reduce power dissipation when the output is short circuited. This feature becomes active when the output drops below 0.8volts, and reduces the current flow by 65%. Full current is restored when the voltage exceeds 0.8 volts.

■ External Capacitors

The AME8804 is stable with an output capacitor to ground of 2.2 μ F or greater. Ceramic capacitors have the lowest ESR, and will offer the best AC performance. Conversely, Aluminum Electrolytic capacitors exhibit the highest ESR, resulting in the poorest AC response. Unfortunately, large value ceramic capacitors are comparatively expensive. One option is to parallel a 0.1 μ F ceramic capacitor with a 10 μ F Aluminum Electrolytic. The benefit is low ESR, high capacitance, and low overall cost.

A second capacitor is recommended between the input and ground to stabilize V_{in} . The input capacitor should be at least 0.1 μ F to have a beneficial effect.

All capacitors should be placed in close proximity to the pins. A "Quiet" ground termination is desirable. This can be achieved with a "Star" connection.

■ Enable

The Enable pin normally floats high. When actively, pulled low, the PMOS pass transistor shuts off, and all internal circuits are powered down. In this state, the quiescent current is less than 1 μ A. This pin behaves much like an electronic switch.

■ Power Good

The AME8804 (SOT-26 package only) includes the Power Good feature. Normally, Pin 4 is "Floating", however, when the output is not within $\pm 10\%$ of the specified voltage, it pulls low. This can occur under the following conditions:

- 1) Input Voltage too low.
- 2) During Over-Temperature.
- 3) During Over-Current.
- 4) If output is pulled up.

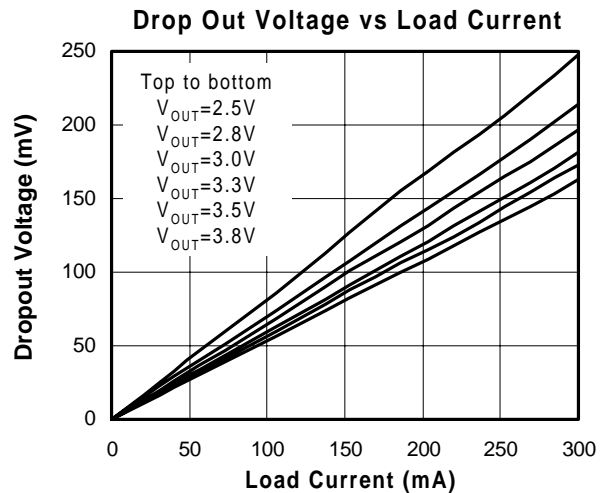
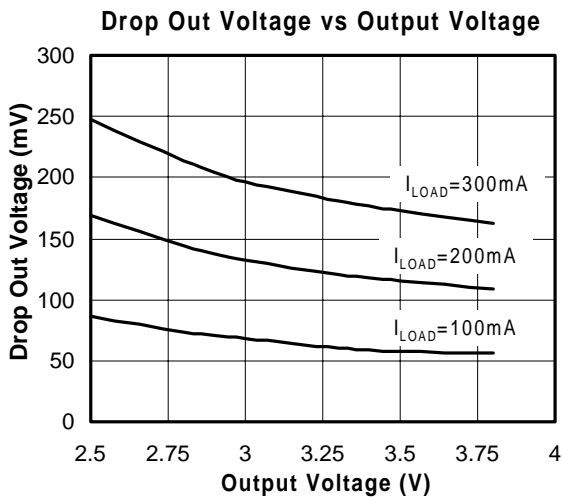
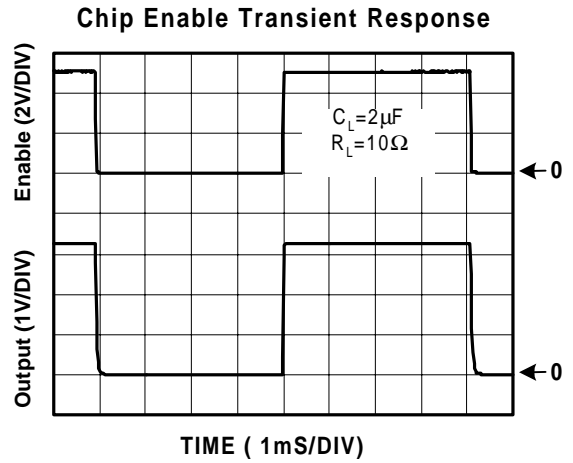
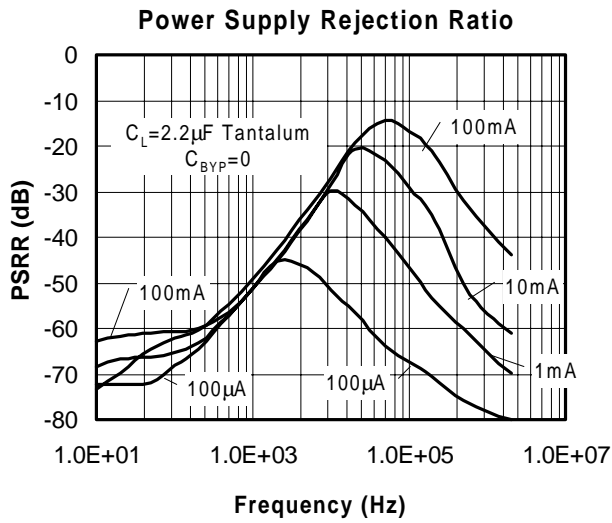
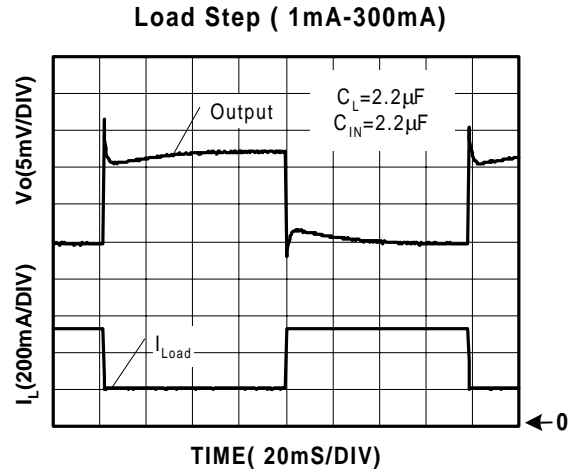
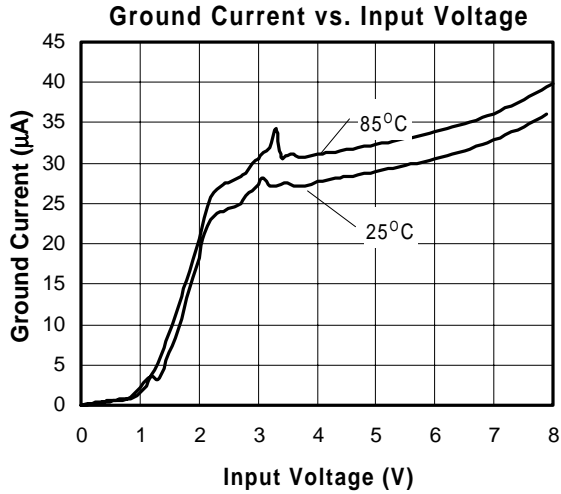



Noise Measurement

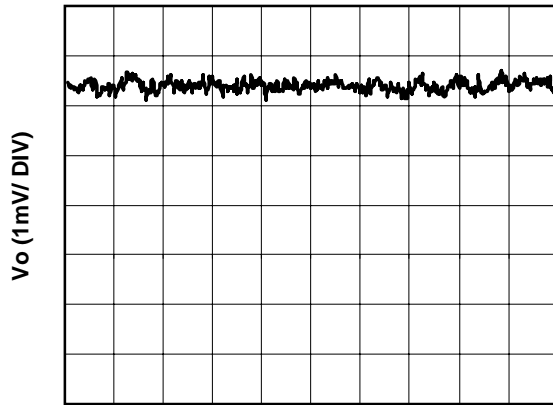

TIME (20mS/DIV)

Safe Operating Area

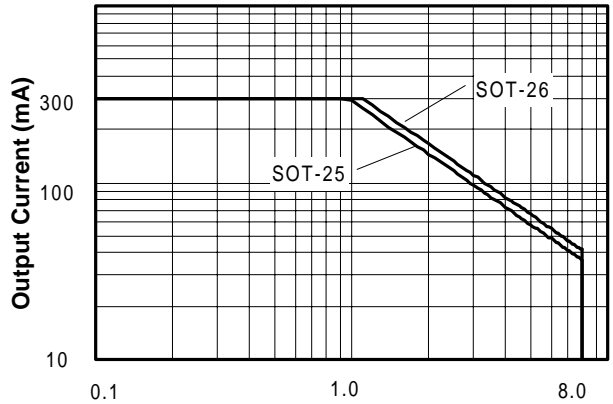

Input-Output Voltage Differential (V)

Short Circuit Response

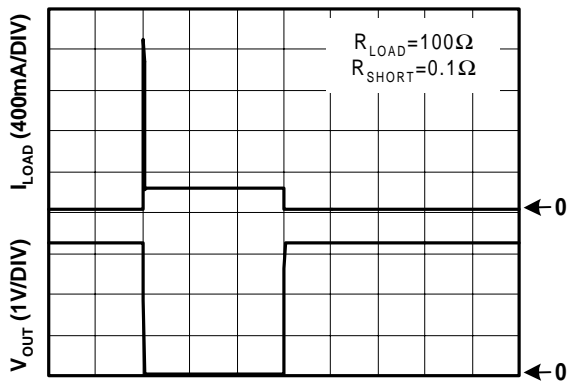

TIME (2mS/DIV)

Overtemperature Shutdown

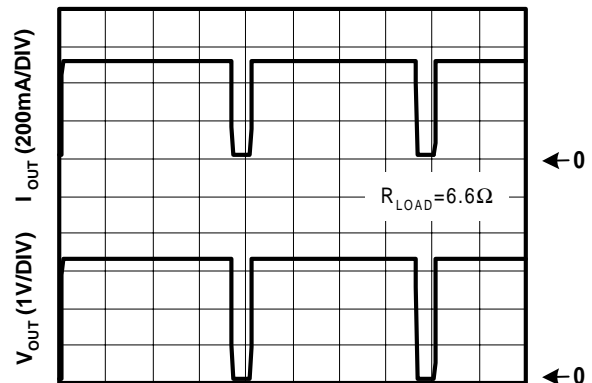

TIME (0.5Sec/DIV)

Current Limit Response

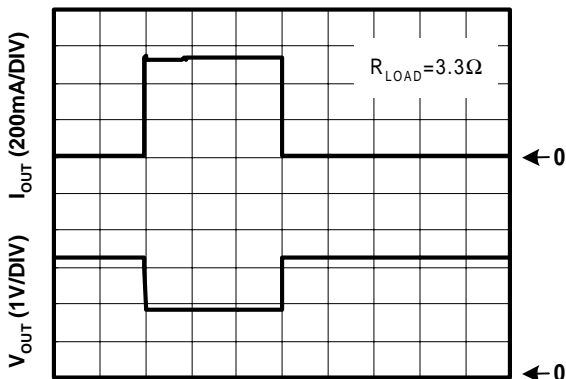

TIME (2mS/DIV)

Line Transient Response

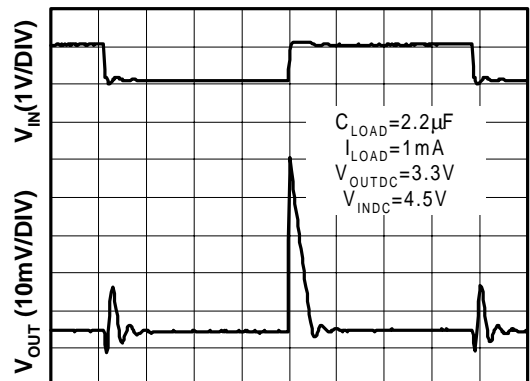

TIME (200mS/DIV)

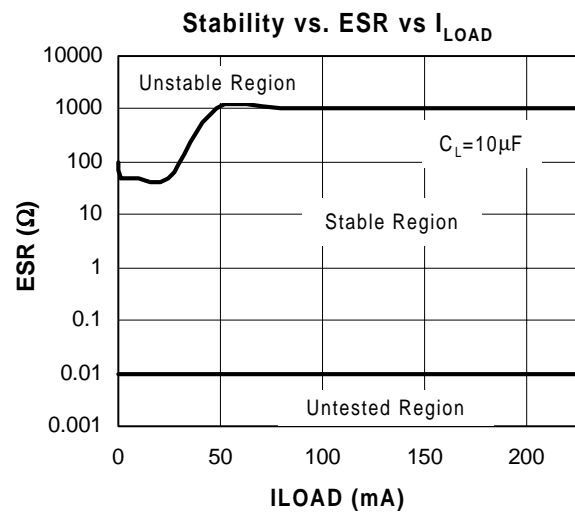
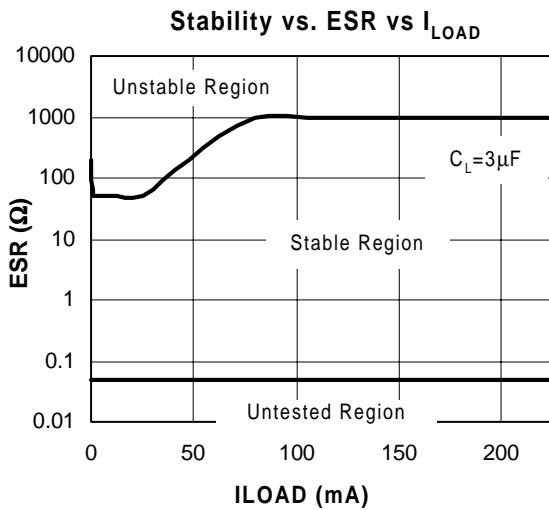
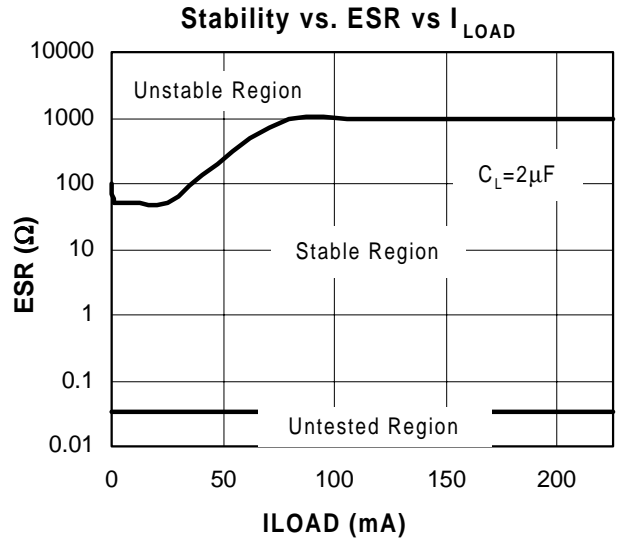
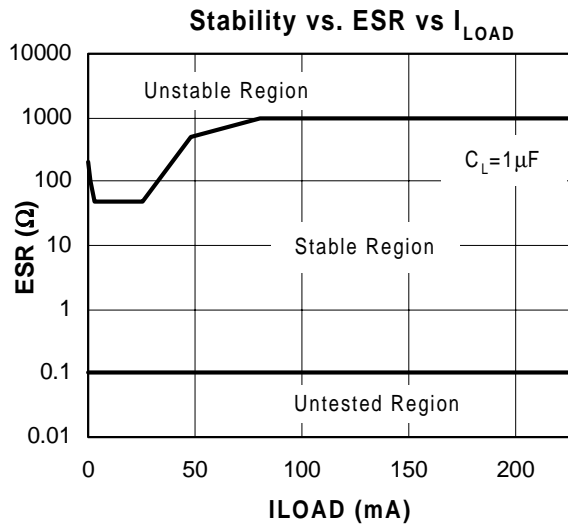



■ External Resistor Divider Table

R1(kohm)	1.00	2.00	5.00	10.00	20.00	50.00	100.00	200.00	500.00	1000.00
Vout	$R2(kohm)=(1.215*R1(kohm))/(Vout-1.215)$									
1.30	14.29	28.59	71.47	142.94	285.88	714.71				
1.35	9.00	18.00	45.00	90.00	180.00	450.00				
1.40	6.57	13.14	32.84	65.68	131.35	328.38				
1.45	5.17	10.34	25.85	51.70	103.40	258.51	517.02			
1.50	4.26	8.53	21.32	42.63	85.26	213.16	426.32	852.63		
1.55	3.63	7.25	18.13	36.27	72.54	181.34	362.69	725.37		
1.60	3.16	6.31	15.78	31.56	63.12	157.79	315.58	631.17		
1.65	2.79	5.59	13.97	27.93	55.86	139.66	279.31	558.62		
1.70	2.51	5.01	12.53	25.05	50.10	125.26	250.52	501.03		
1.75	2.27	4.54	11.36	22.71	45.42	113.55	227.10	454.21		
1.80	2.08	4.15	10.38	20.77	41.54	103.85	207.69	415.38		
1.85	1.91	3.83	9.57	19.13	38.27	95.67	191.34	382.68		
1.90	1.77	3.55	8.87	17.74	35.47	88.69	177.37	354.74		
1.95	1.65	3.31	8.27	16.53	33.06	82.65	165.31	330.61	826.53	
2.00	1.55	3.10	7.74	15.48	30.96	77.39	154.78	309.55	773.89	
2.05	1.46	2.91	7.28	14.55	29.10	72.75	145.51	291.02	727.54	
2.10	1.37	2.75	6.86	13.73	27.46	68.64	137.29	274.58	686.44	
2.15	1.30	2.60	6.50	12.99	25.99	64.97	129.95	259.89	649.73	
2.20	1.23	2.47	6.17	12.34	24.67	61.68	123.35	246.70	616.75	
2.25	1.17	2.35	5.87	11.74	23.48	58.70	117.39	234.78	586.96	
2.30	1.12	2.24	5.60	11.20	22.40	55.99	111.98	223.96	559.91	
2.35	1.07	2.14	5.35	10.70	21.41	53.52	107.05	214.10	535.24	
2.40	1.03	2.05	5.13	10.25	20.51	51.27	102.53	205.06	512.66	
2.45	0.98	1.97	4.92	9.84	19.68	49.19	98.38	196.76	491.90	
2.50	0.95	1.89	4.73	9.46	18.91	47.28	94.55	189.11	472.76	
2.55	0.91	1.82	4.55	9.10	18.20	45.51	91.01	182.02	455.06	
2.60	0.88	1.75	4.39	8.77	17.55	43.86	87.73	175.45	438.63	877.26
2.65	0.85	1.69	4.23	8.47	16.93	42.33	84.67	169.34	423.34	846.69
2.70	0.82	1.64	4.09	8.18	16.36	40.91	81.82	163.64	409.09	818.18
2.75	0.79	1.58	3.96	7.92	15.83	39.58	79.15	158.31	395.77	791.53
2.80	0.77	1.53	3.83	7.67	15.33	38.33	76.66	153.31	383.28	766.56
2.85	0.74	1.49	3.72	7.43	14.86	37.16	74.31	148.62	371.56	743.12
2.90	0.72	1.44	3.61	7.21	14.42	36.05	72.11	144.21	360.53	721.07
2.95	0.70	1.40	3.50	7.00	14.01	35.01	70.03	140.06	350.14	700.29
3.00	0.68	1.36	3.40	6.81	13.61	34.03	68.07	136.13	340.34	680.67
3.05	0.66	1.32	3.31	6.62	13.24	33.11	66.21	132.43	331.06	662.13
3.10	0.64	1.29	3.22	6.45	12.89	32.23	64.46	128.91	322.28	644.56



■ External Resistor Divider Table (contd.)

R1(kohm)	1.00	2.00	5.00	10.00	20.00	50.00	100.00	200.00	500.00	1000.00
Vout	$R2(kohm)=(1.215*R1(kohm))/(Vout-1.215)$									
3.15	0.63	1.26	3.14	6.28	12.56	31.40	62.79	125.58	313.95	627.91
3.20	0.61	1.22	3.06	6.12	12.24	30.60	61.21	122.42	306.05	612.09
3.25	0.60	1.19	2.99	5.97	11.94	29.85	59.71	119.41	298.53	597.05
3.30	0.58	1.17	2.91	5.83	11.65	29.14	58.27	116.55	291.37	582.73
3.35	0.57	1.14	2.85	5.69	11.38	28.45	56.91	113.82	284.54	569.09
3.40	0.56	1.11	2.78	5.56	11.12	27.80	55.61	111.21	278.03	556.06
3.45	0.54	1.09	2.72	5.44	10.87	27.18	54.36	108.72	271.81	543.62
3.50	0.53	1.06	2.66	5.32	10.63	26.59	53.17	106.35	265.86	531.73
3.55	0.52	1.04	2.60	5.20	10.41	26.02	52.03	104.07	260.17	520.34
3.60	0.51	1.02	2.55	5.09	10.19	25.47	50.94	101.89	254.72	509.43
3.65	0.50	1.00	2.49	4.99	9.98	24.95	49.90	99.79	249.49	498.97
3.70	0.49	0.98	2.44	4.89	9.78	24.45	48.89	97.79	244.47	488.93
3.75	0.48	0.96	2.40	4.79	9.59	23.96	47.93	95.86	239.64	479.29
3.80	0.47	0.94	2.35	4.70	9.40	23.50	47.00	94.00	235.01	470.02
3.85	0.46	0.92	2.31	4.61	9.22	23.06	46.11	92.22	230.55	461.10
3.90	0.45	0.91	2.26	4.53	9.05	22.63	45.25	90.50	226.26	452.51
3.95	0.44	0.89	2.22	4.44	8.88	22.21	44.42	88.85	222.12	444.24
4.00	0.44	0.87	2.18	4.36	8.73	21.81	43.63	87.25	218.13	436.27
4.05	0.43	0.86	2.14	4.29	8.57	21.43	42.86	85.71	214.29	428.57
4.10	0.42	0.84	2.11	4.21	8.42	21.06	42.11	84.23	210.57	421.14
4.15	0.41	0.83	2.07	4.14	8.28	20.70	41.40	82.79	206.98	413.97
4.20	0.41	0.81	2.04	4.07	8.14	20.35	40.70	81.41	203.52	407.04
4.25	0.40	0.80	2.00	4.00	8.01	20.02	40.03	80.07	200.16	400.33
4.30	0.39	0.79	1.97	3.94	7.88	19.69	39.38	78.77	196.92	393.84
4.35	0.39	0.78	1.94	3.88	7.75	19.38	38.76	77.51	193.78	387.56
4.40	0.38	0.76	1.91	3.81	7.63	19.07	38.15	76.30	190.74	381.48
4.45	0.38	0.75	1.88	3.76	7.51	18.78	37.56	75.12	187.79	375.58
4.50	0.37	0.74	1.85	3.70	7.40	18.49	36.99	73.97	184.93	369.86
4.55	0.36	0.73	1.82	3.64	7.29	18.22	36.43	72.86	182.16	364.32
4.60	0.36	0.72	1.79	3.59	7.18	17.95	35.89	71.79	179.47	358.94
4.65	0.35	0.71	1.77	3.54	7.07	17.69	35.37	70.74	176.86	353.71
4.70	0.35	0.70	1.74	3.49	6.97	17.43	34.86	69.73	174.32	348.64
4.75	0.34	0.69	1.72	3.44	6.87	17.19	34.37	68.74	171.85	343.71
4.80	0.34	0.68	1.69	3.39	6.78	16.95	33.89	67.78	169.46	338.91
4.85	0.33	0.67	1.67	3.34	6.69	16.71	33.43	66.85	167.13	334.25
4.90	0.33	0.66	1.65	3.30	6.59	16.49	32.97	65.94	164.86	329.72
4.95	0.33	0.65	1.63	3.25	6.51	16.27	32.53	65.06	162.65	325.30
5.00	0.32	0.64	1.61	3.21	6.42	16.05	32.10	64.20	160.50	321.00

Note: Small load (greater than 2 mA) is necessary as R1 or R2 is larger than 50 Kohm. Otherwise, output voltage probably cannot be pulled down to 0 V on disable mode.



■ Package Dimension

SOT-26

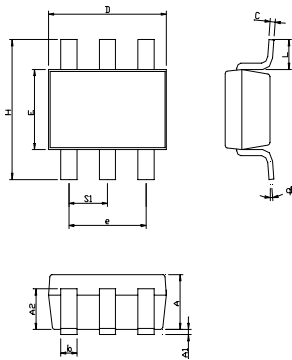

SYMBOLS	MILLIMETERS		INCHES	
	MIN	MAX	MIN	MAX
A	1.00	1.40	0.0394	0.0551
A ₁	0.00	0.15	0.0000	0.0591
A ₂	0.70	1.25	0.0276	0.0492
b	0.35	0.50	0.0138	0.0197
C	0.08	0.25	0.0031	0.0098
D	2.70	3.10	0.1063	0.1220
E	1.40	1.80	0.0551	0.0709
e	1.90 BSC		0.0748 BSC	
H	2.60	3.00	0.1024	0.1181
L	0.35	-	0.0138	-
θ ₁	0°	9°	0°	9°
S ₁	0.85	1.05	0.0335	0.0413

SOT-25

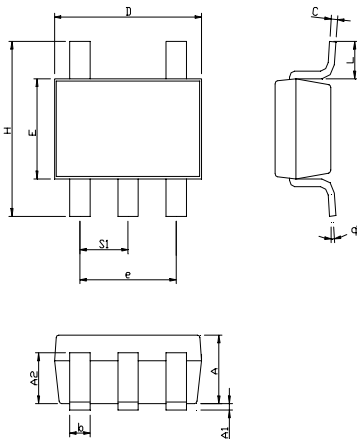

SYMBOLS	MILLIMETERS		INCHES	
	MIN	MAX	MIN	MAX
A	1.00	1.45	0.0394	0.0571
A ₁	0.00	0.15	0.0000	0.0591
A ₂	0.70	1.25	0.0276	0.0492
b	0.35	0.55	0.0138	0.0217
C	0.08	0.25	0.0031	0.0098
D	2.70	3.10	0.1063	0.1220
E	1.40	1.80	0.0551	0.0709
e	1.90 BSC		0.07480 BSC	
H	2.60	3.00	0.1024	0.1181
L	0.30	-	0.0118	-
θ ₁	0°	10°	0°	10°
S ₁	0.85	1.05	0.0335	0.0413



www.analogmicro.com
E-Mail: info@analogmicro.com

Life Support Policy:

These products of Analog Microelectronics, Inc. are not authorized for use as critical components in life-support devices or systems, without the express written approval of the president of Analog Microelectronics, Inc.

Analog Microelectronics, Inc. reserves the right to make changes in the circuitry and specifications of its devices and advises its customers to obtain the latest version of relevant information.

© Analog Microelectronics, Inc., August 2001

Document: 2006-DS8804-E

Corporate Headquarters
Analog Microelectronics, Inc.

3100 De La Cruz Blvd. Suite 201
Santa Clara, CA. 95054-2046
Tel : (408) 988-2388
Fax: (408) 988-2489

Asia Pacific Headquarters
AME, Inc.

2F, 187 Kang-Chien Road, Nei-Hu District
Taipei 114, Taiwan, R.O.C.
Tel : 886 2 2627-8687
Fax: 886 2 2659-2989