



4.5Ω/20Ω, 300MHz Bandwidth, Dual SPDT Analog Switches in UCSP

General Description

The MAX4717/MAX4718 low-voltage, low on-resistance (R_{ON}), dual single-pole/double throw (SPDT) analog switches operate from a single +1.8V to +5.5V supply. These devices are designed for USB 1.1 and audio switching applications.

The MAX4717 features two 4.5Ω R_{ON} (max) SPDT switches with 1.2Ω flatness and 0.3Ω matching between channels. The MAX4718 features one 4.5Ω R_{ON} (max) SPDT switch and one 20Ω R_{ON} (max) SPDT switch. The 20Ω switch has a guaranteed matching and flatness of 0.4Ω and 1.2Ω, respectively. These switches offer break-before-make switching (1ns) with t_{ON} <80ns and t_{OFF} <40ns at +2.7V. The digital logic inputs are +1.8V logic compatible with a +2.7V to +3.6V supply.

These switches are packaged in a chip-scale package (UCSP™), significantly reducing the required PC board area. The chip occupies only a 2.0mm × 1.50mm area and has a 4 × 3 bump array with a bump pitch of 0.5mm. These switches are also available in 10-pin μMAX® and 10-pin TDFN packages.

Applications

USB 1.1 Signal Switching Circuits
 Battery-Operated Equipment
 Audio/Video-Signal Routing
 Headphone Switching
 Low-Voltage Data-Acquisition Systems
 Sample-and-Hold Circuits
 Cell Phones
 PDAs

UCSP is a trademark of Maxim Integrated Products, Inc.
 μMAX is a registered trademark of Maxim Integrated Products, Inc.

Features

- ◆ USB 1.1 Signal Switching Compliant
- ◆ 2ns (max) Differential Skew
- ◆ -3dB Bandwidth: >300MHz
- ◆ Low 15pF On-Channel Capacitance
- ◆ Single-Supply Operation from +1.8V to +5.5V
- ◆ 4.5Ω R_{ON} (max) Switches (MAX4717/MAX4718)
 0.3Ω (max) R_{ON} Match (+3.0V Supply)
 1.2Ω (max) Flatness (+3.0V Supply)
- ◆ 20Ω R_{ON} (max) Switch (MAX4718)
 0.4Ω (max) R_{ON} Match (+3.0V Supply)
 1.2Ω (max) Flatness (+3.0V Supply)
- ◆ Rail-to-Rail Signal Handling
- ◆ High Off-Isolation: -55dB (10MHz)
- ◆ Low Crosstalk: -80dB (10MHz)
- ◆ Low Distortion: 0.03%
- ◆ +1.8V CMOS-Logic Compatible
- ◆ <0.5nA Leakage Current at +25°C

Ordering Information

| PART | TEMP RANGE | PIN/BUMP-PACKAGE | TOP MARK |
|---------------|----------------|------------------|----------|
| MAX4717EUB | -40°C to +85°C | 10 μMAX | — |
| MAX4717ETB | -40°C to +85°C | 10 TDFN-EP** | ACV |
| MAX4717EBC-T* | -40°C to +85°C | 12 UCSP-12 | ABH |
| MAX4718EUB | -40°C to +85°C | 10 μMAX | — |
| MAX4718ETB | -40°C to +85°C | 10 TDFN-EP** | ACW |
| MAX4718EBC-T* | -40°C to +85°C | 12 UCSP-12 | ABI |

*UCSP reliability is integrally linked to the user's assembly methods, circuit board material, and environment. See the UCSP reliability notice in the UCSP Reliability section of this data sheet for more information.

**EP = Exposed paddle.

Pin Configurations/Functional Diagrams/Truth Tables

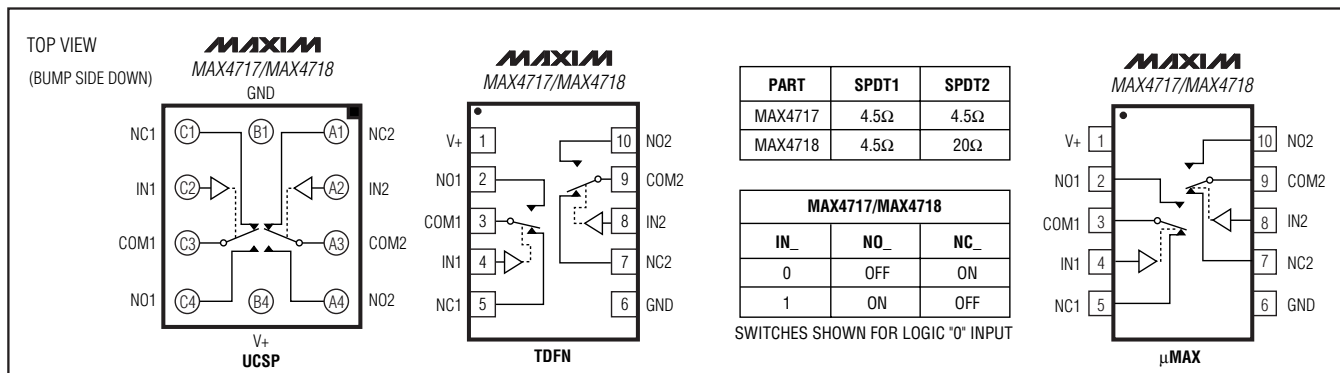

4.5Ω/20Ω, 300MHz Bandwidth, Dual SPDT Analog Switches in UCSP

ABSOLUTE MAXIMUM RATINGS

(All Voltages Referenced to GND)

| | |
|---|----------------------|
| V+, IN_ | -0.3V to +6.0V |
| COM_, NO_, NC_ (Note 1) | -0.3V to (V+ + 0.3V) |
| Continuous Current COM_, NO_, NC_ | ±100mA |
| Peak Current COM_, NO_, NC_ (pulsed at 1ms, 10% duty cycle) | ±200mA |
| Continuous Power Dissipation (T _A = +70°C) | |
| 10-Pin μMAX (derate 5.6mW/°C above +70°C) | 444mW |
| 10-Pin TDFN (derate 24.4mW/°C above +70°C) | 1951mW |
| 12-Bump UCSP (derate 11.4mW/°C above +70°C) | 909mW |

| | |
|---------------------------------------|-----------------|
| ESD Method 3015.7 | >2kV |
| Operating Temperature Range | -40°C to +85°C |
| Junction Temperature | +150°C |
| Storage Temperature Range | -65°C to +150°C |
| Lead Temperature (soldering, 10s) | +300°C |
| Bump Temperature (soldering) (Note 2) | |
| Infrared (15s) | +220°C |
| Vapor Phase (60s) | +215°C |

Note 1: Signals on COM_, NO_, or NC_ exceeding V+ or GND are clamped by internal diodes. Limit forward-diode current to maximum current rating.

Note 2: This device is constructed using a unique set of packaging techniques that impose a limit on the thermal profile the device can be exposed to during board level solder attach and rework. This limit permits only the use of the solder profiles recommended in the industry standard specification, JEDEC 020A, paragraph 7.6, table 3 for IR/VPR and convection reflow. Preheating is required. Hand or wave soldering is not allowed.

Stresses beyond those listed under "Absolute Maximum Ratings" may cause permanent damage to the device. These are stress ratings only, and functional operation of the device at these or any other conditions beyond those indicated in the operational sections of the specifications is not implied. Exposure to absolute maximum rating conditions for extended periods may affect device reliability.

ELECTRICAL CHARACTERISTICS—Single +3V Supply

(V+ = +2.7V to +3.6V, V_{IH} = +1.4V, V_{IL} = +0.5V, T_A = T_{MIN} to T_{MAX}, unless otherwise noted. Typical values are at V+ = +3.0V, T_A = +25°C, unless otherwise noted.) (Notes 3, 4)

| PARAMETER | SYMBOL | CONDITIONS | T _A | MIN | TYP | MAX | UNITS |
|--|--|---|---|------|-------|------|-------|
| Analog Signal Range | V _{COM_} , V _{NO_} , V _{NC_} | | T _{MIN} to T _{MAX} | 0 | | V+ | V |
| ANALOG SWITCH (Low R_{ON}—MAX4717/MAX4718 SPDT 1) | | | | | | | |
| On-Resistance (Note 5) | R _{ON} | V+ = 2.7V, I _{COM_} = 10mA; V _{NO_} or V _{NC_} = 1.5V | +25°C | | 3.0 | 4.5 | Ω |
| | | | T _{MIN} to T _{MAX} | | | 5 | |
| On-Resistance Match Between Channels (Notes 5, 6) | ΔR _{ON} | V+ = 2.7V, I _{COM_} = 10mA; V _{NO_} or V _{NC_} = 1.5V | +25°C | | 0.1 | 0.3 | Ω |
| | | | T _{MIN} to T _{MAX} | | | 0.4 | |
| On-Resistance Flatness (Note 7) | R _{FLAT(ON)} | V+ = 2.7V, I _{COM_} = 10mA; V _{NO_} or V _{NC_} = 1.0V, 1.5V, 2.0V | +25°C | | 0.6 | 1.2 | Ω |
| | | | T _{MIN} to T _{MAX} | | | 1.5 | |
| NO_, NC_ Off-Leakage Current (Note 8) | I _{NO_(OFF)} , I _{NC_(OFF)} | V+ = 3.6V, V _{COM_} = 0.3V, 3.3V; V _{NO_} or V _{NC_} = 3.3V, 0.3V | +25°C | -0.5 | +0.01 | +0.5 | nA |
| | | | T _{MIN} to T _{MAX} | -1 | | +1 | |
| COM_ On-Leakage Current (Note 8) | I _{COM_(ON)} | V+ = 3.6V, V _{COM_} = 0.3V, 3.3V; V _{NO_} or V _{NC_} = 0.3V, 3.3V, or floating | +25°C | -1 | +0.01 | +1 | nA |
| | | | T _{MIN} to T _{MAX} | -2 | | +2 | |
| ANALOG SWITCH (High R_{ON}—MAX4718 SPDT 2) | | | | | | | |
| On-Resistance (Note 5) | R _{ON} | V+ = 2.7V, I _{COM_} = 10mA; V _{NO_} or V _{NC_} = 1.5V | +25°C | | 15 | 20 | Ω |
| | | | T _{MIN} to T _{MAX} | | | 25 | |

4.5Ω/20Ω, 300MHz Bandwidth, Dual SPDT Analog Switches in UCSP

MAX4717/MAX4718

ELECTRICAL CHARACTERISTICS—Single +3V Supply (continued)

(V+ = +2.7V to +3.6V, V_{IH} = +1.4V, V_{IL} = +0.5V, T_A = T_{MIN} to T_{MAX}, unless otherwise noted. Typical values are at V+ = +3.0V, T_A = +25°C, unless otherwise noted.) (Notes 3, 4)

| PARAMETER | SYMBOL | CONDITIONS | T _A | MIN | TYP | MAX | UNITS |
|---|---|--|--|------|-------|------|-------|
| On-Resistance Match Between Channels (Notes 5, 6) | ΔR _{ON} | V+ = 2.7V, I _{COM_} = 10mA; V _{NO_} or V _{NC_} = 1.5V | +25°C | | 0.15 | 0.4 | Ω |
| | | | T _{MIN} to T _{MAX} | | | 0.5 | |
| On-Resistance Flatness (Note 7) | R _{FLAT(ON)} | V+ = 2.7V, I _{COM_} = 10mA; V _{NO_} or V _{NC_} = 1.0V, 1.5V, 2.0V | +25°C | | 0.6 | 1.2 | Ω |
| | | | T _{MIN} to T _{MAX} | | | 1.5 | |
| NO_, NC_ Off-Leakage Current (Note 8) | I _{NO_(OFF)} , I _{NC_(OFF)} | V+ = 3.6V, V _{COM_} = 0.3V, 3.3V; V _{NO_} or V _{NC_} = 3.3V, 0.3V | +25°C | -0.5 | +0.01 | +0.5 | nA |
| | | | T _{MIN} to T _{MAX} | -1 | | +1 | |
| COM_ On-Leakage Current (Note 8) | I _{COM_(ON)} | V+ = 3.6V, V _{COM_} = 0.3V, 3.3V; V _{NO_} or V _{NC_} = 0.3V, 3.3V, or floating | +25°C | -1 | +0.01 | +1 | nA |
| | | | T _{MIN} to T _{MAX} | -2 | | +2 | |
| DYNAMIC CHARACTERISTICS | | | | | | | |
| Turn-On Time | t _{ON} | V _{NO_} , V _{NC_} = 1.5V; R _L = 300Ω, C _L = 35pF, Figure 1; V _{IH} = 1.5V, V _{IL} = 0V | +25°C | | 40 | 80 | ns |
| | | | T _{MIN} to T _{MAX} | | | 100 | |
| Turn-Off Time | t _{OFF} | V _{NO_} , V _{NC_} = 1.5V; R _L = 300Ω, C _L = 35pF, Figure 1; V _{IH} = 1.5V, V _{IL} = 0V | +25°C | | 20 | 40 | ns |
| | | | T _{MIN} to T _{MAX} | | | 50 | |
| Break-Before-Make Time Delay (Note 8) | t _{BBM} | V _{NO_} , V _{NC_} = 1.5V; R _L = 300Ω, C _L = 35pF, Figure 2 | +25°C | | 8 | | ns |
| | | | T _{MIN} to T _{MAX} | 1 | | | |
| Skew (Note 8) | t _{SKEW} | R _S = 39Ω, C _L = 50pF, Figure 3 | T _{MIN} to T _{MAX} | | 0.15 | 2 | ns |
| Charge Injection | Q | V _{GEN} = 1.5V, R _{GEN} = 0Ω, C _L = 1.0nF, Figure 4 | +25°C | | 5 | | pC |
| Off-Isolation | V _{ISO} | f = 10MHz; V _{NO_} , V _{NC_} = 1V _{P-P} ; R _L = 50Ω, C _L = 5pF, Figure 5 | +25°C | | -55 | | dB |
| | | | f = 1MHz; V _{NO_} , V _{NC_} = 1V _{P-P} ; R _L = 50Ω, C _L = 5pF, Figure 5 | | | -80 | |
| Crosstalk (Note 9) | V _{CT} | f = 10MHz; V _{NO_} , V _{NC_} = 1V _{P-P} ; R _L = 50Ω, C _L = 5pF, Figure 5 | +25°C | | -80 | | dB |
| | | | f = 1MHz; V _{NO_} , V _{NC_} = 1V _{P-P} ; R _L = 50Ω, C _L = 5pF, Figure 5 | | | -110 | |
| On-Channel -3dB Bandwidth | BW | Signal = 0dBm, R _L = 50Ω, C _L = 5pF, Figure 5 | +25°C | | >300 | | MHz |
| Total Harmonic Distortion | THD | V _{COM} = 2V _{P-P} , R _L = 600Ω | +25°C | | 0.03 | | % |
| NO_, NC_ Off-Capacitance | C _{NO_(OFF)} , C _{NC_(OFF)} | f = 1MHz, Figure 6 | +25°C | | 9 | | pF |

4.5Ω/20Ω, 300MHz Bandwidth, Dual SPDT Analog Switches in UCSP

ELECTRICAL CHARACTERISTICS—Single +3V Supply (continued)

(V+ = +2.7V to +3.6V, V_{IH} = +1.4V, V_{IL} = +0.5V, T_A = T_{MIN} to T_{MAX}, unless otherwise noted. Typical values are at V+ = +3.0V, T_A = +25°C, unless otherwise noted.) (Notes 3, 4)

| PARAMETER | SYMBOL | CONDITIONS | T _A | MIN | TYP | MAX | UNITS |
|--------------------------|-------------------|--|--------------------------------------|------|-----|------|-------|
| Switch On-Capacitance | C _(ON) | f = 1MHz, Figure 6 | +25°C | | 15 | | pF |
| DIGITAL I/O | | | | | | | |
| Input Logic High Voltage | V _{IH} | | T _{MIN} to T _{MAX} | 1.4 | | | V |
| Input Logic Low Voltage | V _{IL} | | T _{MIN} to T _{MAX} | | | 0.5 | V |
| Input Leakage Current | I _{IIN} | V+ = +3.6V, V _{IN_} = 0 or 5.5V | T _{MIN} to T _{MAX} | -100 | | +100 | nA |
| POWER SUPPLY | | | | | | | |
| Power-Supply Range | V+ | | T _{MIN} to T _{MAX} | 1.8 | | 5.5 | V |
| Supply Current | I+ | V+ = +5.5V, V _{IN_} = 0V or V+ | T _{MIN} to T _{MAX} | | | 1 | μA |

ELECTRICAL CHARACTERISTICS—Single +5V Supply

(V+ = +4.2V to +5.5V, V_{IH} = +2.0V, V_{IL} = +0.8V, T_A = T_{MIN} to T_{MAX}, unless otherwise noted. Typical values are at V+ = +5.0V, T_A = +25°C, unless otherwise noted.) (Notes 3, 4)

| PARAMETER | SYMBOL | CONDITIONS | T _A | MIN | TYP | MAX | UNITS |
|---|--|--|--------------------------------------|------|-------|------|-------|
| Analog Signal Range | V _{COM_} , V _{NO_} , V _{NC_} | | T _{MIN} to T _{MAX} | 0 | | V+ | V |
| ANALOG SWITCH (Low Ron—MAX4717/MAX4718 SPDT 1) | | | | | | | |
| On-Resistance (Note 5) | R _{ON} | V+ = 4.2V, I _{COM_} = 10mA; V _{NO_} or V _{NC_} = 3.5V | +25°C | | 1.7 | 3 | Ω |
| | | | T _{MIN} to T _{MAX} | | | 3.5 | |
| On-Resistance Match Between Channels (Notes 5, 6) | ΔR _{ON} | V+ = 4.2V, I _{COM_} = 10mA; V _{NO_} or V _{NC_} = 3.5V | +25°C | | 0.1 | 0.3 | Ω |
| | | | T _{MIN} to T _{MAX} | | | 0.4 | |
| On-Resistance Flatness (Note 7) | R _{FLAT(ON)} | V+ = 4.2V, I _{COM_} = 10mA; V _{NO_} or V _{NC_} = 1.0V, 2.0V, 3.5V | +25°C | | 0.4 | 1.2 | Ω |
| | | | T _{MIN} to T _{MAX} | | | 1.5 | |
| NO_, NC_ Off-Leakage Current (Note 8) | I _{NO_(OFF)} , I _{NC_(OFF)} | V+ = 5.5V; V _{COM_} = 1.0V, 4.5V; V _{NO_} or V _{NC_} = 1.0V, 4.5V | +25°C | -0.5 | +0.01 | +0.5 | nA |
| | | | T _{MIN} to T _{MAX} | -1 | | +1 | |
| COM_ On-Leakage Current (Note 8) | I _{COM_(ON)} | V+ = 5.5V; V _{COM_} = 1.0V, 4.5V; V _{NO_} or V _{NC_} = 1.0V, 4.5V, or floating | +25°C | -1 | +0.01 | +1 | nA |
| | | | T _{MIN} to T _{MAX} | -2 | | +2 | |

4.5Ω/20Ω, 300MHz Bandwidth, Dual SPDT Analog Switches in UCSP

MAX4717/MAX4718

ELECTRICAL CHARACTERISTICS—Single +5V Supply (continued)

(V+ = +4.2V to +5.5V, VIH = +2.0V, VIL = +0.8V, TA = TMIN to TMAX, unless otherwise noted. Typical values are at V+ = +5.0V, TA = +25°C, unless otherwise noted.) (Notes 3, 4)

| PARAMETER | SYMBOL | CONDITIONS | TA | MIN | TYP | MAX | UNITS |
|---|-------------------------|--|--------------|------|-------|------|-------|
| ANALOG SWITCH (High RON—MAX4718 SPDT 2) | | | | | | | |
| On-Resistance (Note 5) | RON | V+ = 4.2V, ICOM_ = 10mA; VNO_ or VNC_ = 3.5V | +25°C | | 12 | 20 | Ω |
| | | | TMIN to TMAX | | | 25 | |
| On-Resistance Match Between Channels (Notes 5, 6) | ΔRON | V+ = 4.2V, ICOM_ = 10mA; VNO_ or VNC_ = 3.5V | +25°C | | 0.15 | 0.4 | Ω |
| | | | TMIN to TMAX | | | 0.5 | |
| On-Resistance Flatness (Note 7) | RFLAT(ON) | V+ = 4.2V, ICOM_ = 10mA; VNO_ or VNC_ = 1.0V, 2.0V, 4.5V | +25°C | | 0.4 | 1.2 | Ω |
| | | | TMIN to TMAX | | | 1.5 | |
| NO_, NC_ Off-Leakage Current (Note 8) | INO_(OFF), INC_(OFF) | V+ = 5.5V; VCOM_ = 1.0V, 4.5V; VNO_ or VNC_ = 1.0V, 4.5V | +25°C | -0.5 | +0.01 | +0.5 | nA |
| | | | TMIN to TMAX | -1 | | +1 | |
| COM_ On-Leakage Current (Note 8) | ICOM_(ON) | V+ = 5.5V, VCOM_ = 1.0V, 4.5V; VNO_ or VNC_ = 1.0V, 4.5V, or floating | +25°C | -1 | +0.01 | +1 | nA |
| | | | TMIN to TMAX | -2 | | +2 | |
| DYNAMIC CHARACTERISTICS | | | | | | | |
| Turn-On Time | tON | VNO_, VNC_ = 3.0V; RL = 300Ω, CL = 35pF, Figure 1 | +25°C | | 30 | 80 | ns |
| | | | TMIN to TMAX | | | 100 | |
| Turn-Off Time | tOFF | VNO_, VNC_ = 3.0V; RL = 300Ω, CL = 35pF, Figure 1 | +25°C | | 20 | 40 | ns |
| | | | TMIN to TMAX | | | 50 | |
| Break-Before-Make Time Delay (Note 8) | tBBM | VNO_, VNC_ = 3.0V; RL = 300Ω, CL = 35pF, Figure 2 | +25°C | | 8 | | ns |
| | | | TMIN to TMAX | 1 | | | |
| Skew (Note 8) | tsKEW | RS = 39Ω, CL = 50pF, Figure 3 | TMIN to TMAX | | 0.15 | 2 | ns |
| DIGITAL I/O | | | | | | | |
| Input Logic High Voltage | VIH | | TMIN to TMAX | 2.0 | | | V |
| Input Logic Low Voltage | VIL | | TMIN to TMAX | | | 0.8 | V |
| Input Leakage Current | IIN | V+ = 5.5V, VIN_ = 0V or V+ | TMIN to TMAX | -100 | | +100 | nA |

4.5Ω/20Ω, 300MHz Bandwidth, Dual SPDT Analog Switches in UCSP

ELECTRICAL CHARACTERISTICS—Single +5V Supply (continued)

(V+ = +4.2V to +5.5V, V_{IH} = +2.0V, V_{IL} = +0.8V, T_A = T_{MIN} to T_{MAX}, unless otherwise noted. Typical values are at V+ = +5.0V, T_A = +25°C, unless otherwise noted.) (Notes 3, 4)

| PARAMETER | SYMBOL | CONDITIONS | T _A | MIN | TYP | MAX | UNITS |
|---------------------|--------|--|--------------------------------------|-----|-----|-----|-------|
| POWER SUPPLY | | | | | | | |
| Power-Supply Range | V+ | | T _{MIN} to T _{MAX} | 1.8 | | 5.5 | V |
| Supply Current | I+ | V+ = 5.5V, V _{IN-} = 0V or V+ | T _{MIN} to T _{MAX} | | | 1 | μA |

Note 3: UCSP and TDFN parts are 100% tested at +25°C only, and guaranteed by design over the specified temperature range. μMAX parts are 100% tested at T_{MAX} and guaranteed by design over the specified temperature range.

Note 4: The algebraic convention used in this data sheet is where the most negative value is a minimum and the most positive value is a maximum.

Note 5: Guaranteed by design for UCSP and TDFN parts.

Note 6: ΔRON = RON(MAX) - RON(MIN).

Note 7: Flatness is defined as the difference between the maximum and minimum value of on-resistance as measured over the specified analog signal ranges.

Note 8: Guaranteed by design.

Note 9: Between any two switches.

Typical Operating Characteristics

(T_A = +25°C, unless otherwise noted.)

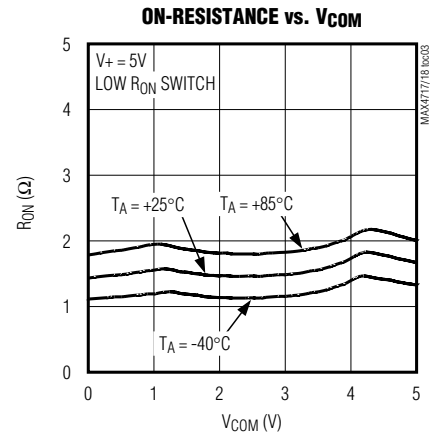
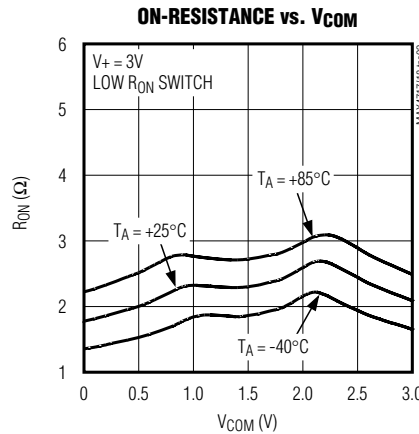
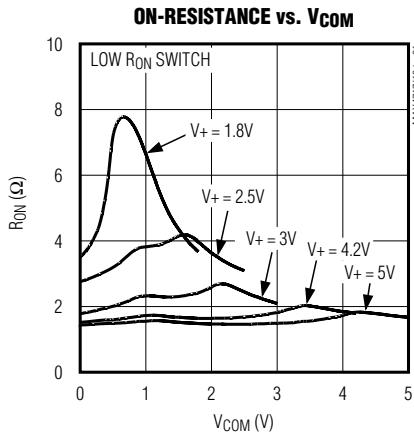

4.5Ω/20Ω, 300MHz Bandwidth, Dual SPDT Analog Switches in UCSP

Typical Operating Characteristics (continued)

($T_A = +25^\circ\text{C}$, unless otherwise noted.)

MAX4717/MAX4718

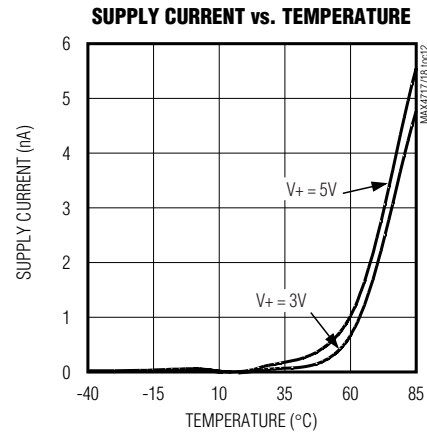
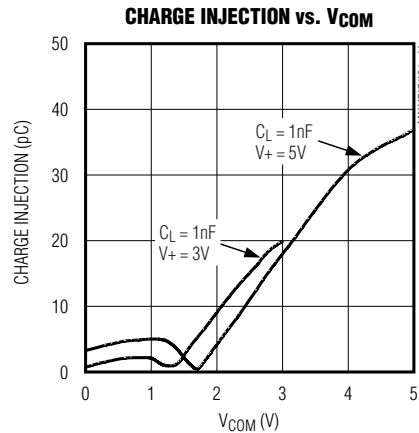
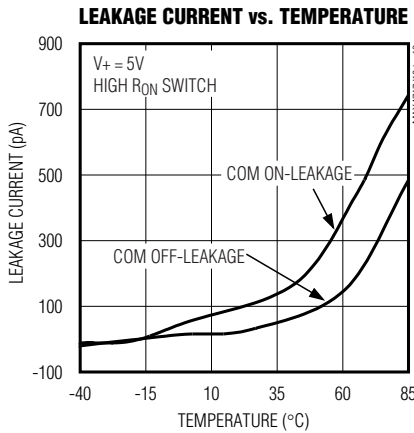
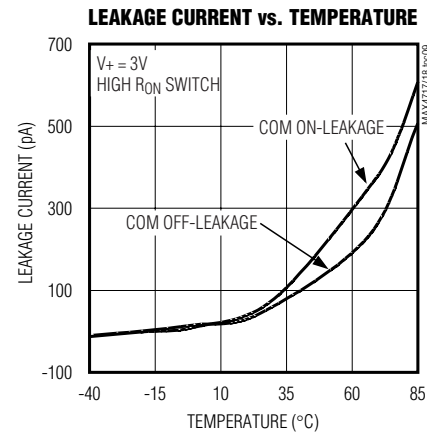
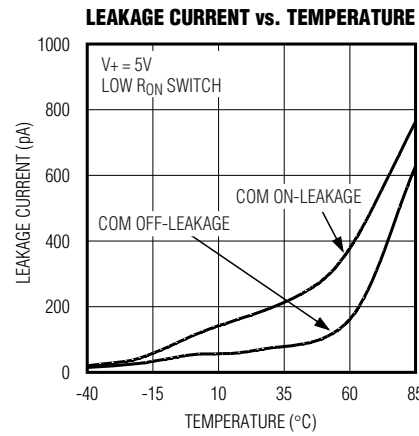
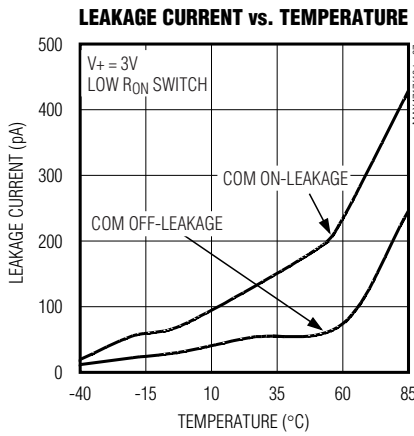
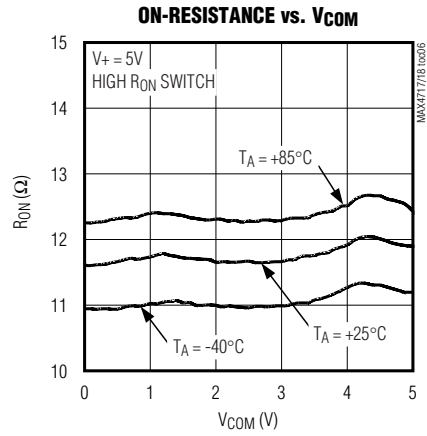
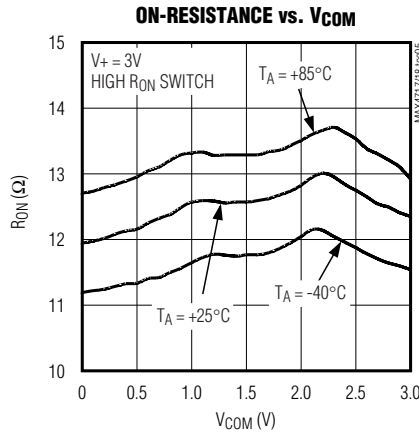
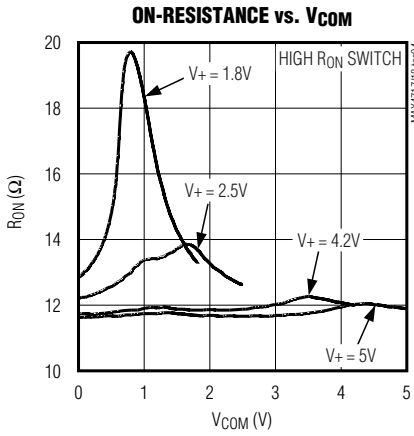

4.5Ω/20Ω, 300MHz Bandwidth, Dual SPDT Analog Switches in UCSP

Typical Operating Characteristics (continued)

(T_A = +25°C, unless otherwise noted.)

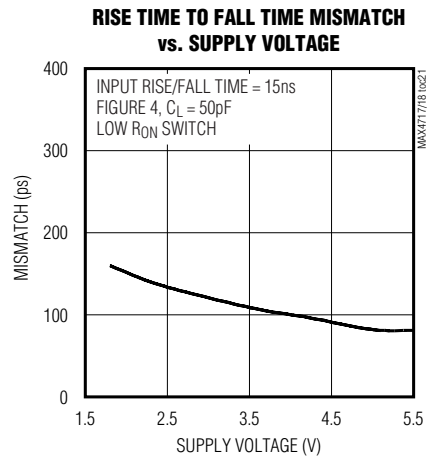
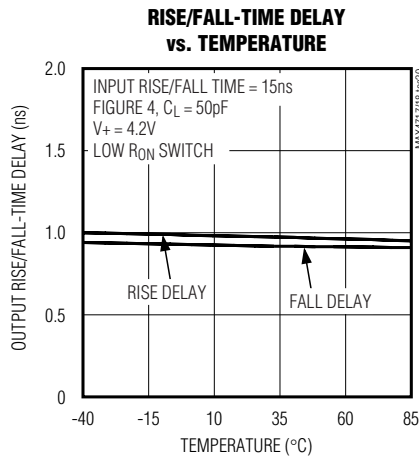
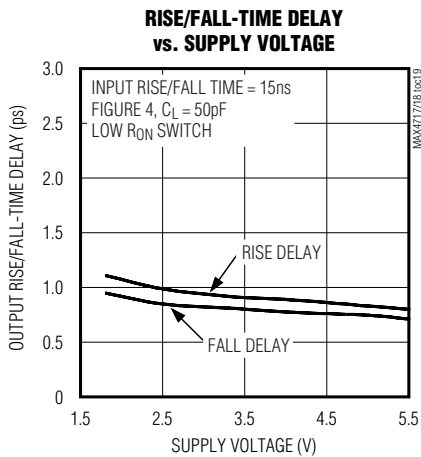
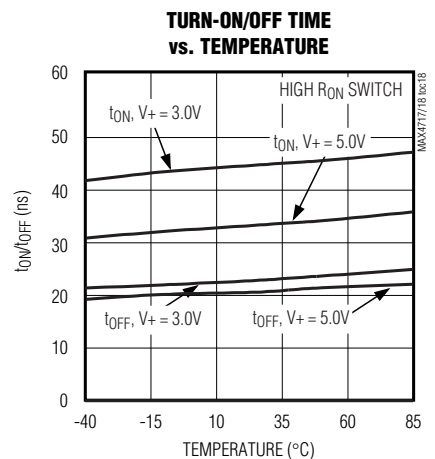
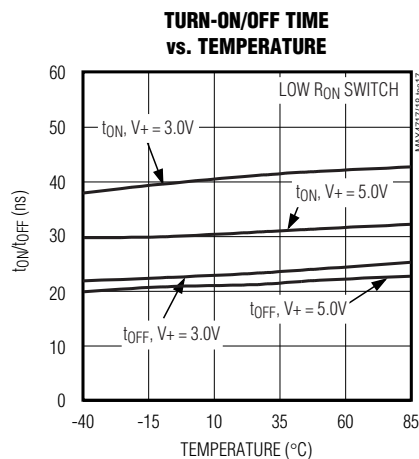
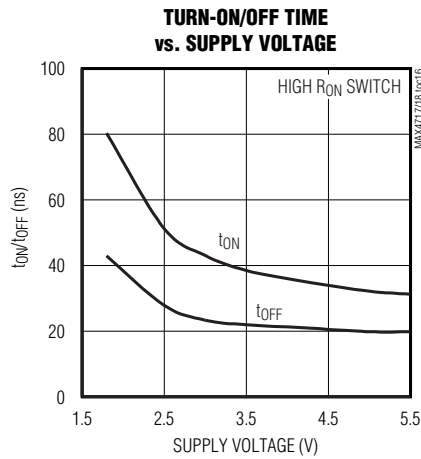
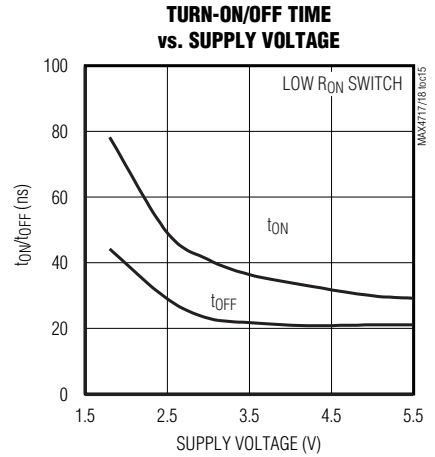
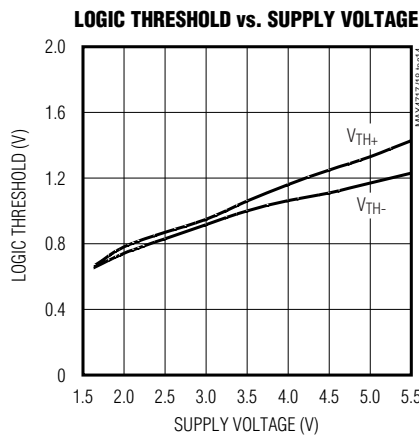
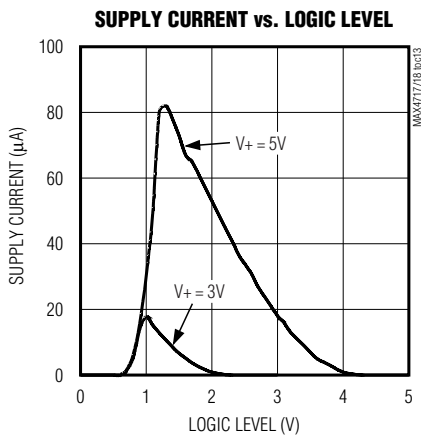

4.5Ω/20Ω, 300MHz Bandwidth, Dual SPDT Analog Switches in UCSP

Typical Operating Characteristics (continued)

(T_A = +25°C, unless otherwise noted.)

MAX4717/MAX4718

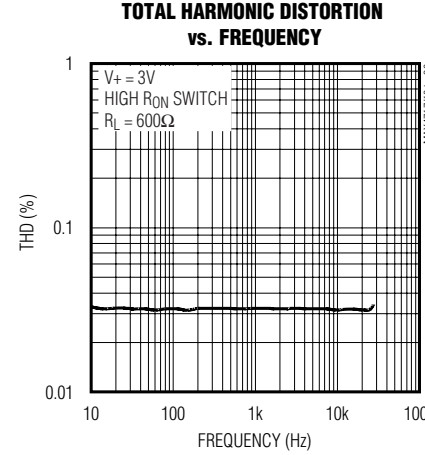
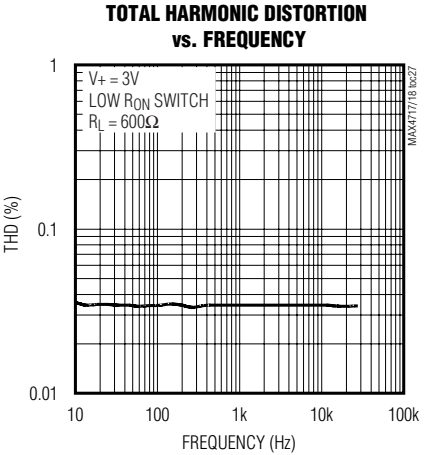
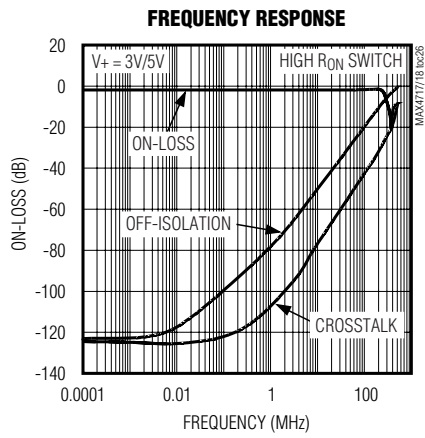
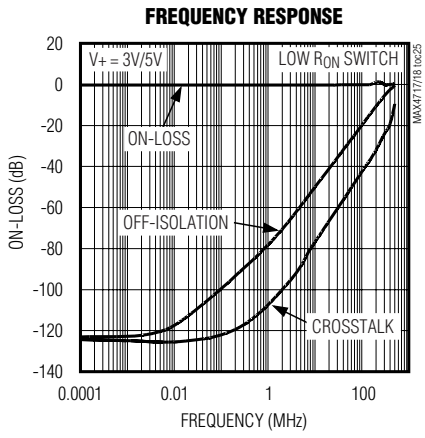
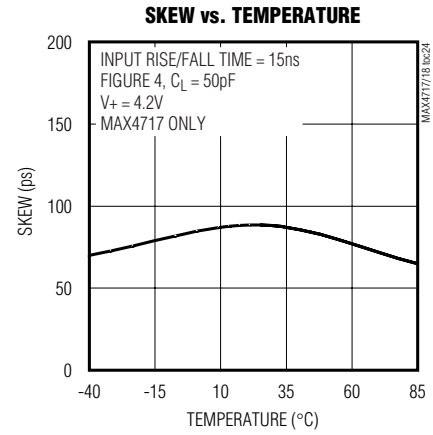
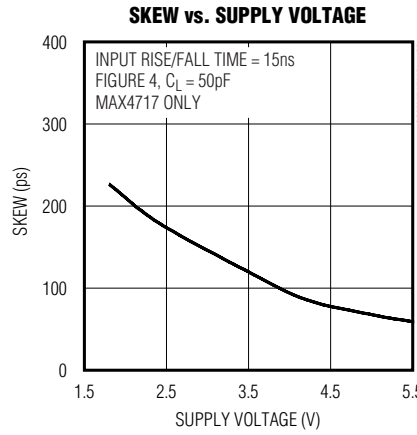
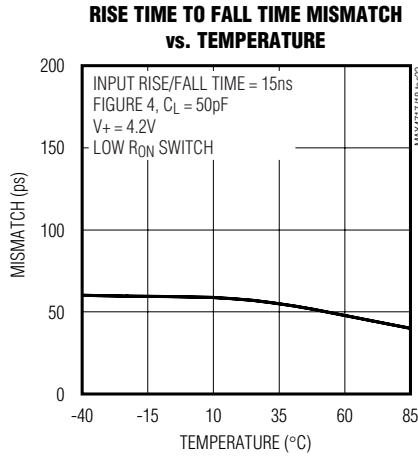

4.5Ω/20Ω, 300MHz Bandwidth, Dual SPDT Analog Switches in UCSP

Pin Description

| PIN | | NAME | FUNCTION |
|------|-----------|------|---|
| UCSP | μMAX/TDFN | | |
| A1 | 7 | NC2 | Analog Switch 2—Normally Closed Terminal |
| A2 | 8 | IN2 | Analog Switch 2—Digital Control Input |
| A3 | 9 | COM2 | Analog Switch 2—Common Terminal |
| A4 | 10 | NO2 | Analog Switch 2—Normally Open Terminal |
| B1 | 6 | GND | Ground. Connection. |
| B4 | 1 | V+ | Positive-Supply Voltage |
| C1 | 5 | NC1 | Analog Switch 1—Normally Closed Terminal |
| C2 | 4 | IN1 | Analog Switch 1—Digital Control Input |
| C3 | 3 | COM1 | Analog Switch 1—Common Terminal |
| C4 | 2 | NO1 | Analog Switch 1—Normally Open Terminal |
| — | — | EP | Exposed Pad (for TDFN package only). Connect to ground. |

Detailed Description

The MAX4717/MAX4718 high-speed, low-voltage, low on-resistance (R_{ON}), dual SPDT analog switches operate from a single +1.8V to +5.5V supply. The switches feature break-before-make switching operation and fast switching speeds ($t_{ON} = 80\text{ns}$ (max), $t_{OFF} = 40\text{ns}$ (max)).

These switches have low 15pF on-channel capacitance, which allows for 12Mbps switching of the data signals for USB 1.0/1.1 applications. The MAX4717 is designed to switch D+ and D- USB signals with a guaranteed skew of less than 2ns (see Figure 4) as measured from 50% of the input signal to 50% of the output signal.

Applications Information

Digital Control Inputs

The MAX4717/MAX4718 logic inputs accept up to +5.5V regardless of supply voltage. For example, with a +3.3V supply, IN_ can be driven low to GND and high to +5.5V allowing for mixing of logic levels in a system. Driving the control logic inputs rail-to-rail minimizes power consumption. For a +3V supply voltage, the logic thresholds are 0.5V (low) and 1.4V (high); for a +5V supply voltage, the logic thresholds are 0.8V (low) and 2.0V (high).

Analog Signal Levels

The on-resistance of the MAX4717/MAX4718 changes very little for analog input signals across the entire supply voltage range (see the *Typical Operating Characteristics*). The switches are bidirectional, so the NO_, NC_, and COM_ pins can be either inputs or outputs.

Power-Supply Sequencing and Overvoltage Protection

Caution: Do not exceed the absolute maximum ratings because stresses beyond the listed ratings may cause permanent damage to the device.

Proper power-supply sequencing is recommended for all CMOS devices. Always apply V+ before applying analog signals, especially if the analog signal is not current-limited.

UCSP Application Information

For the latest application details on UCSP construction, dimensions, tape carrier information, printed circuit board techniques, bump-pad layout, and recommended reflow temperature profile as well as the latest information on reliability testing results, go to the Maxim web site at www.maxim-ic.com/ucsp to find the Application Note: *USCP—A Wafer-Level Chip-Scale Package*.

Chip Information

TRANSISTOR COUNT: 235

PROCESS: BiCMOS

4.5Ω/20Ω, 300MHz Bandwidth, Dual SPDT Analog Switches in UCSP

Test Circuits/Timing Diagrams

MAX4717/MAX4718

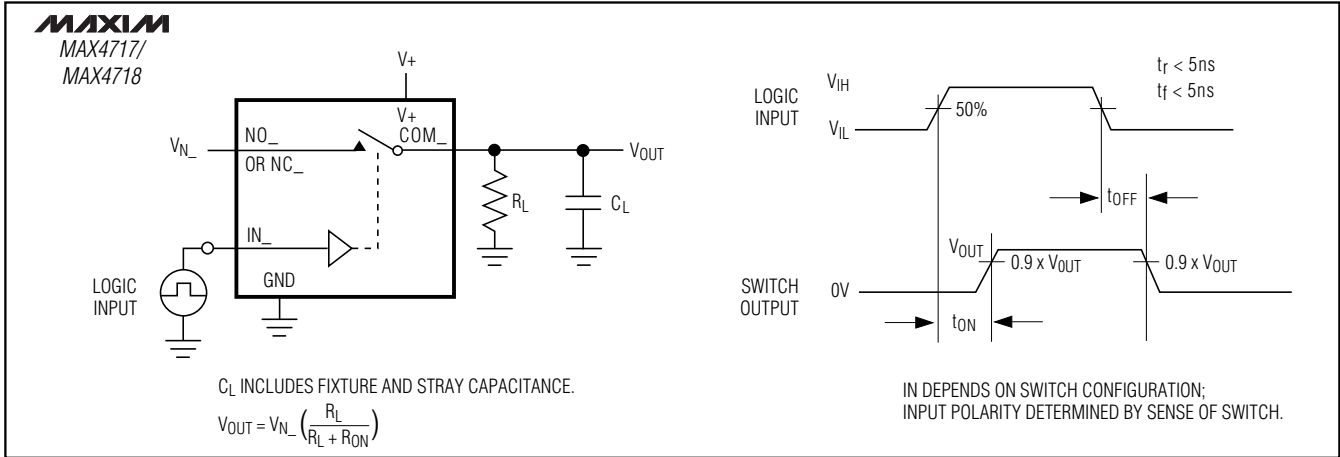

Figure 1. Switching Time

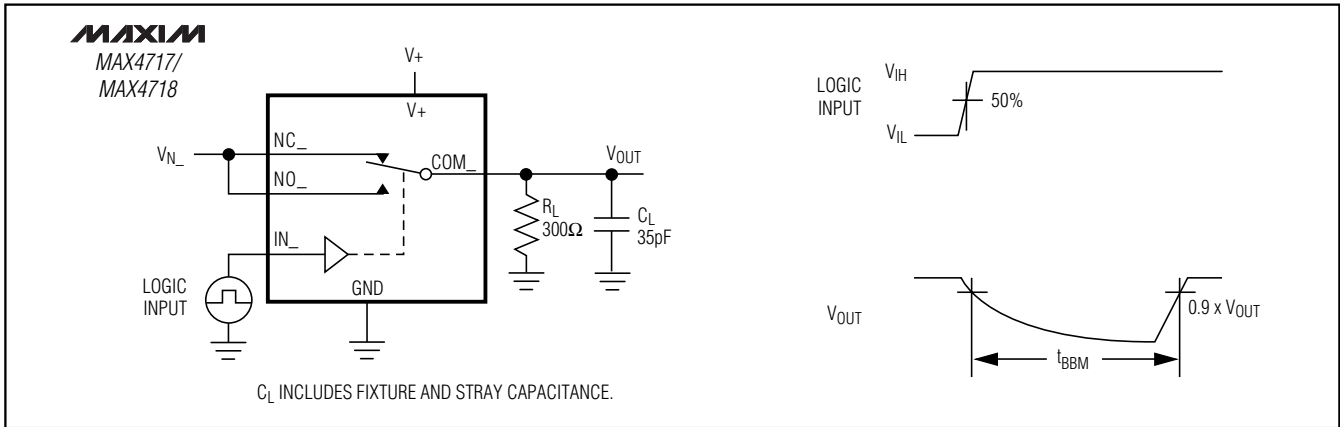

Figure 2. Break-Before-Make Interval

4.5Ω/20Ω, 300MHz Bandwidth, Dual SPDT Analog Switches in UCSP

Test Circuits/Timing Diagrams (continued)

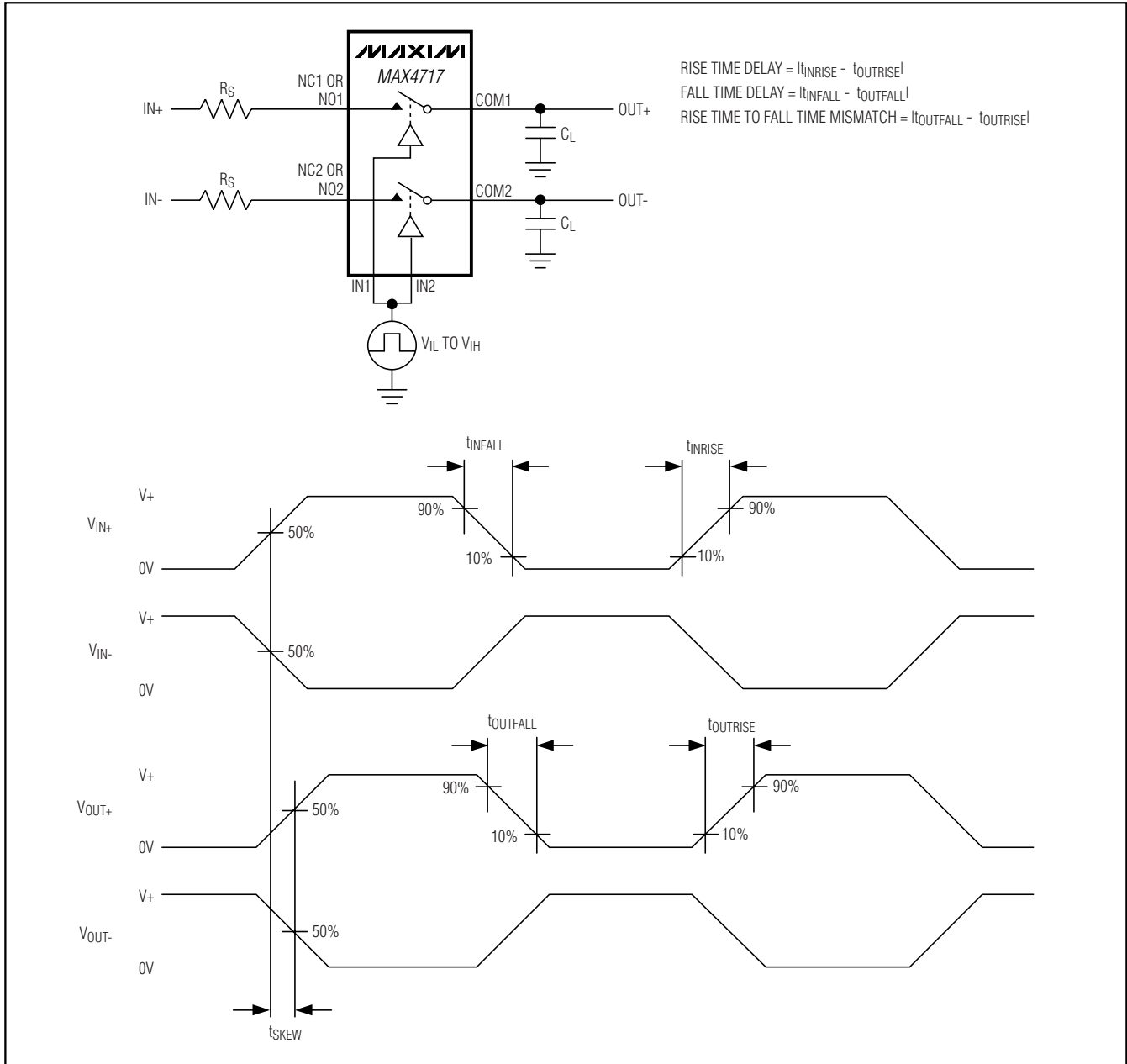

Figure 3. Output Signal Skew

4.5Ω/20Ω, 300MHz Bandwidth, Dual SPDT Analog Switches in UCSP

Package Information

(The package drawing(s) in this data sheet may not reflect the most current specifications. For the latest package outline information go to www.maxim-ic.com/packages.)

TOP VIEW

| COMMON DIMENSIONS | |
|-------------------|----------------|
| A | 0.62±0.05-0.08 |
| A1 | 0.29±0.02 |
| A2 | 0.33 REF. |
| b | ∅0.35±0.03 |
| D1 | 1.00 BASIC |
| E1 | 1.50 BASIC |
| e | 0.50 BASIC |
| SD | 0.00 BASIC |
| SE | 0.25 BASIC |

| PKG. CODE | VARIABLE DIMENSIONS | | DEPOPULATED SOLDER BALLS |
|-----------|---------------------|-----------|--------------------------|
| | D | E | |
| B12-1 | 1.54±0.05 | 2.02±0.05 | NONE |
| B12-2 | 1.54±0.05 | 2.02±0.05 | B3 |
| B12-3 | 1.54±0.05 | 2.12±0.05 | NONE |
| B12-4 | 1.54±0.05 | 2.02±0.05 | B2, B3 |
| B12-5 | 1.64±0.05 | 2.12±0.05 | B2 |
| B12-6 | 1.64±0.05 | 2.12±0.05 | B3 |
| B12-7 | 1.54±0.05 | 2.02±0.05 | B1, B3 |
| B12-8 | 1.54±0.05 | 2.02±0.05 | B2 |
| B12-9 | 1.54±0.05 | 2.12±0.05 | B2, B3 |
| B12-10 | 1.54±0.05 | 2.02±0.05 | B1, B2, B3, B4 |
| B12-11 | 1.54±0.05 | 2.02±0.05 | A2, C3 |

NOTES:

- ALL DIMENSIONS ARE IN MILLIMETERS.
- PRODUCT MARKING: NUMBER OF CHARACTERS AND LINES VARY PER PRODUCT.

SIDE VIEW

BOTTOM VIEW

| | |
|-------------------------------------|---------------------------------|
| | |
| PROPRIETARY INFORMATION | |
| TITLE: PACKAGE OUTLINE, 4x3 UCSP | |
| APPROVAL | DOCUMENT CONTROL NO. 21-0104 |
| REV. F | 1/1 |

12L, UCSP 4x3 EPS

4.5Ω/20Ω, 300MHz Bandwidth, Dual SPDT Analog Switches in UCSP

Package Information (continued)

(The package drawing(s) in this data sheet may not reflect the most current specifications. For the latest package outline information go to www.maxim-ic.com/packages.)

MAX4717/MAX4718

10LUMAXEPS

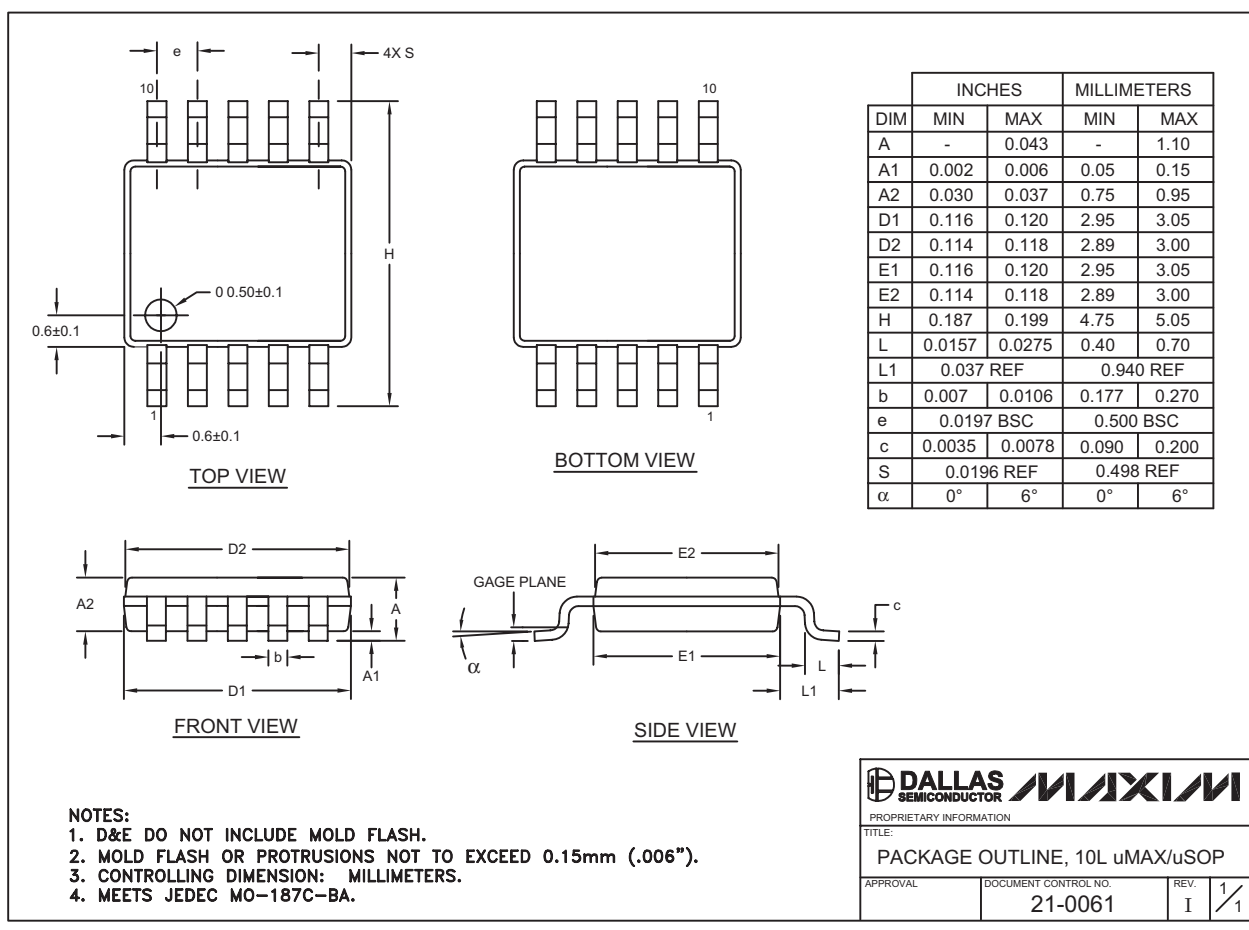

4.5Ω/20Ω, 300MHz Bandwidth, Dual SPDT Analog Switches in UCSP

Package Information (continued)

(The package drawing(s) in this data sheet may not reflect the most current specifications. For the latest package outline information go to www.maxim-ic.com/packages.)

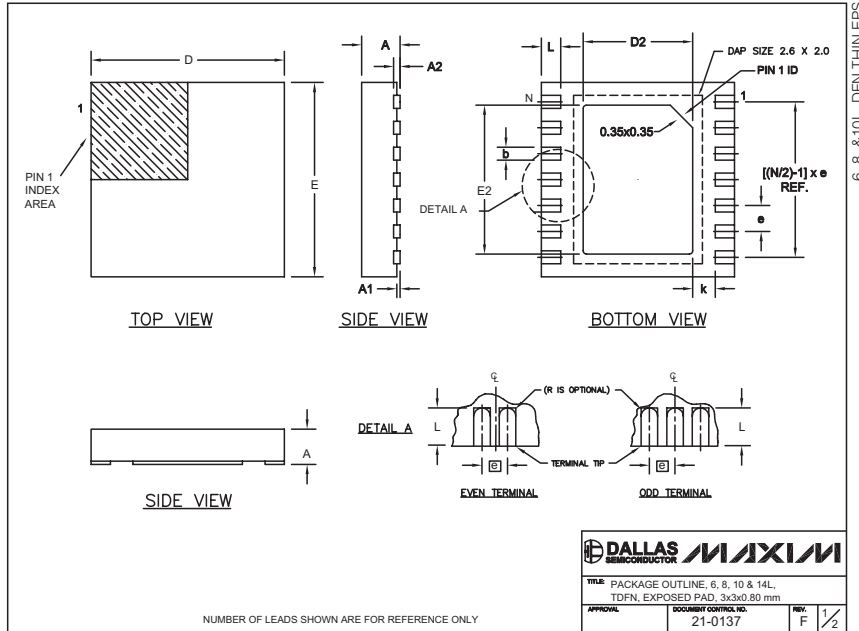

| COMMON DIMENSIONS | | |
|-------------------|-----------|------|
| SYMBOL | MIN. | MAX. |
| A | 0.70 | 0.80 |
| D | 2.90 | 3.10 |
| E | 2.90 | 3.10 |
| A1 | 0.00 | 0.05 |
| L | 0.20 | 0.40 |
| k | 0.25 MIN. | |
| A2 | 0.20 REF. | |

| PACKAGE VARIATIONS | | | | | | | |
|--------------------|----|-----------|-----------|----------|----------------|-----------|---------------|
| PKG. CODE | N | D2 | E2 | e | JEDEC SPEC | b | [(N/2)-1] x e |
| T633-1 | 6 | 1.50±0.10 | 2.30±0.10 | 0.95 BSC | MO229 / WEEA | 0.40±0.05 | 1.90 REF |
| T833-1 | 8 | 1.50±0.10 | 2.30±0.10 | 0.65 BSC | MO229 / WEEC | 0.30±0.05 | 1.95 REF |
| T1033-1 | 10 | 1.50±0.10 | 2.30±0.10 | 0.50 BSC | MO229 / WEED-3 | 0.25±0.05 | 2.00 REF |
| T1433-1 | 14 | 1.70±0.10 | 2.30±0.10 | 0.40 BSC | ---- | 0.20±0.03 | 2.40 REF |
| T1433-2 | 14 | 1.70±0.10 | 2.30±0.10 | 0.40 BSC | ---- | 0.20±0.03 | 2.40 REF |

NOTES:
 1. ALL DIMENSIONS ARE IN mm. ANGLES IN DEGREES.
 2. COPLANARITY SHALL NOT EXCEED 0.08 mm.
 3. WARPAGE SHALL NOT EXCEED 0.10 mm.
 4. PACKAGE LENGTH/PACKAGE WIDTH ARE CONSIDERED AS SPECIAL CHARACTERISTIC(S).
 5. DRAWING CONFORMS TO JEDEC MO229, EXCEPT DIMENSIONS "D2" AND "E2", AND T1433-1 & T1433-2.
 6. "N" IS THE TOTAL NUMBER OF LEADS.

Maxim cannot assume responsibility for use of any circuitry other than circuitry entirely embodied in a Maxim product. No circuit patent licenses are implied. Maxim reserves the right to change the circuitry and specifications without notice at any time.