

P-Channel Enhancement Mode Power MOSFET

MTP425I3

BV_{DSS}	-30V
I_D	-50A
R_{DS(ON)}@ V_{GS}=-10V, I_D=-10A	10mΩ (typ)
R_{DS(ON)}@ V_{GS}=-5V, I_D=-7A	14mΩ (typ)

Features

- Single Drive Requirement
- Low On-resistance
- Fast switching Characteristic
- Pb-free lead plating package

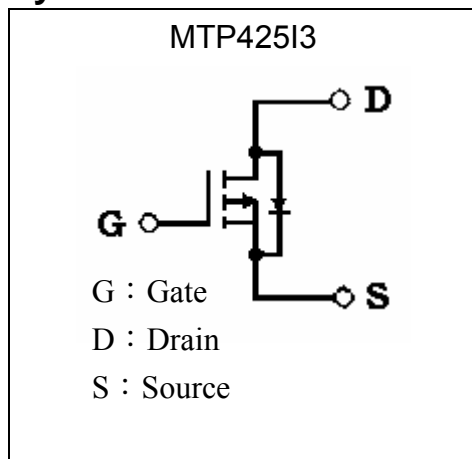
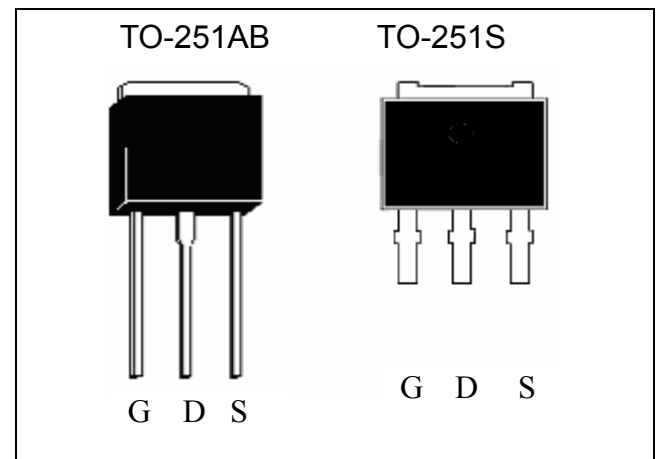
Symbol

Outline

Absolute Maximum Ratings (T_a=25°C)

Parameter		Symbol	Limits	Unit
Drain-Source Voltage		V _{DS}	-30	V
Gate-Source Voltage		V _{GS}	±25	
Continuous Drain Current @V _{GS} =-10V, T _C =25°C		I _D	-50	A
Continuous Drain Current @V _{GS} =-10V, T _C =100°C			-32	
Continuous Drain Current @V _{GS} =-10V, T _A =25°C			-11	
Continuous Drain Current @V _{GS} =-10V, T _A =100°C			-7	
Pulsed Drain Current		I _{DM}	-100 *1	
Power Dissipation	T _C =25°C	P _D	50 *4	W
	T _C =100°C		20 *4	
	T _A =25°C		2.5	
	T _A =100°C		1.0	
Single Pulse Avalanche Energy		E _{AS}	30 *2	mJ
Single Pulse Avalanche Current		I _{AS}	-11	A
Operating Junction and Storage Temperature		T _j , T _{stg}	-55~+150	°C



Thermal Data

Parameter	Symbol	Value	Unit
Thermal Resistance, Junction-to-case, max	R _{th,j-c}	2.5	°C/W
Thermal Resistance, Junction-to-ambient, max	R _{th,j-a}	50 *3	°C/W

- Note : *1. Pulse width limited by safe operating area.
 *2. T_j=25°C, V_{DD}=-15V, L=0.5mH, R_G=25Ω.
 *3. The value of R_{th,j-a} is measured with the device mounted on 1 in²FR-4 board with 2 oz. copper, in a still air environment with T_A=25°C. The value in any given application depends on the user's specific board design.
 *4. The power dissipation P_D is more useful in setting the upper dissipation limit for cases where additional heatsinking is used. It is used to determined the current rating, when this rating falls below the package limit.

Characteristics (T_j=25°C, unless otherwise specified)

Symbol	Min.	Typ.	Max.	Unit	Test Conditions
Static					
BV _{DSS}	-30	-	-	V	V _{GS} =0, I _D =-250μA
V _{GS(th)}	-1.0	-1.5	-2.5	V	V _{DS} = V _{GS} , I _D =-250μA
G _{FS}	-	20	-	S	V _{DS} =-5V, I _D =-10A
I _{GSS}	-	-	±100	nA	V _{GS} =±25
I _{DSS}	-	-	-1	μA	V _{DS} =-30V, V _{GS} =0
I _{DSS}	-	-	-5		V _{DS} =-24V, V _{GS} =0, T _j =55°C
*R _{DS(ON)}	-	9.7	13	mΩ	V _{GS} =-10V, I _D =-10A
*R _{DS(ON)}	-	14	18		V _{GS} =-5V, I _D =-7A
Dynamic					
*Q _g	-	32	-	nC	I _D =-25A, V _{DS} =-15V, V _{GS} =-10V
*Q _{gs}	-	11.3	-		
*Q _{gd}	-	8.4	-		
*t _{d(ON)}	-	17	-	ns	V _{DS} =-15V, V _{GS} =-10V, R _G =6Ω, I _D =-1A
*t _r	-	10	-		
*t _{d(OFF)}	-	85	-		
*t _f	-	23	-		
C _{iss}	-	2825	-	pF	V _{GS} =0V, V _{DS} =-15V, f=1MHz
C _{oss}	-	248	-		
C _{rss}	-	191	-		
Source-Drain Diode					
*V _{SD}	-	-0.75	-1.2	V	I _S =-3A, V _{GS} =0V
*I _S	-	-	-50	A	I _S =-25A, V _{GS} =0, dI/dt=100A/μs
*t _{rr}	-	26	-	ns	
*Q _{rr}	-	18	-	nC	

*Pulse Test : Pulse Width ≤300μs, Duty Cycle≤2%

Ordering Information

Device	Package	Shipping
MTP425I3B-0-UB-G	TO-251AB (Pb-free lead plating and halogen-free package)	80 pcs / tube, 50 tubes / box
MTP425I3S-0-UB-G	TO-251S (Pb-free lead plating and halogen-free package)	80 pcs / tube, 50 tubes / box



Typical Characteristics

Typical Output Characteristics

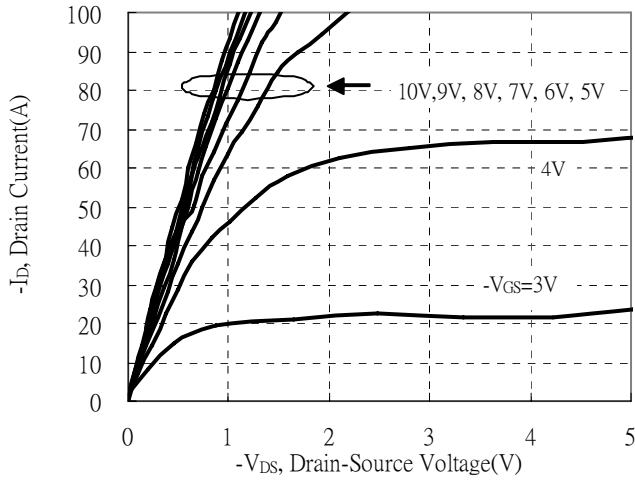

Breakdown Voltage vs Ambient Temperature

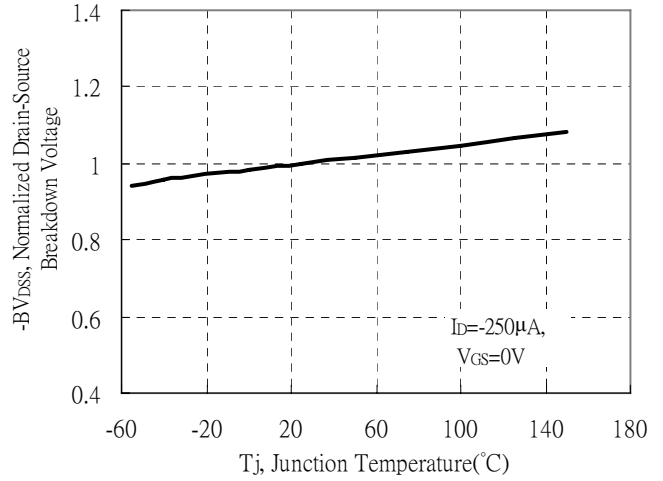

Static Drain-Source On-State resistance vs Drain Current

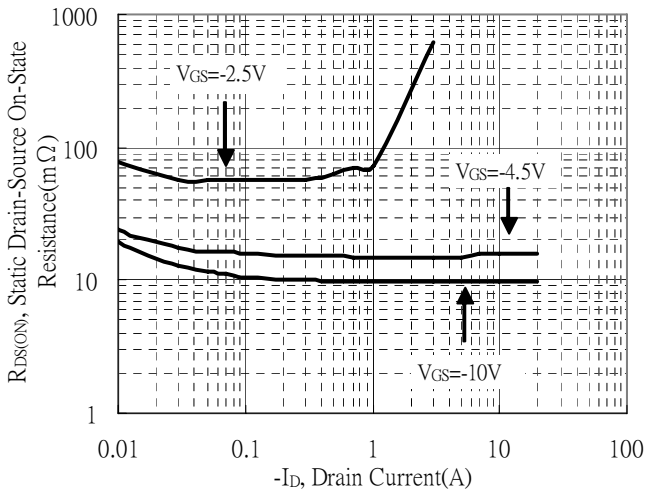

Reverse Drain Current vs Source-Drain Voltage

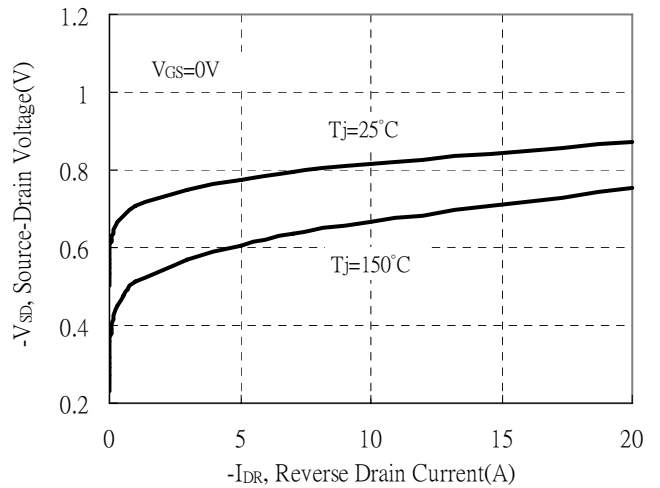

Static Drain-Source On-State Resistance vs Gate-Source Voltage

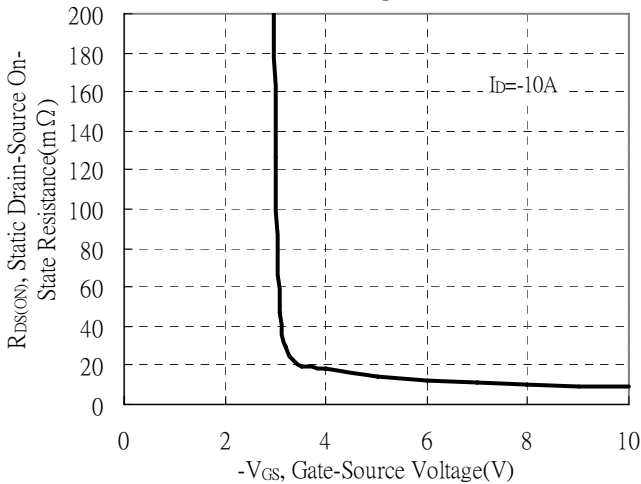

Drain-Source On-State Resistance vs Junction Temperature

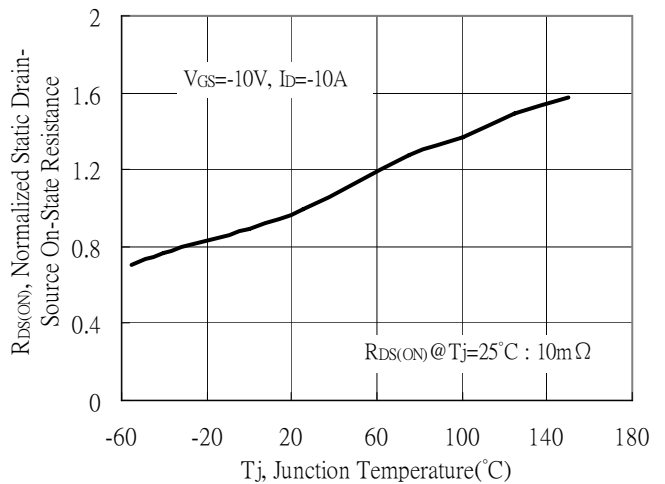

Typical Characteristics(Cont.)

Capacitance vs Drain-to-Source Voltage

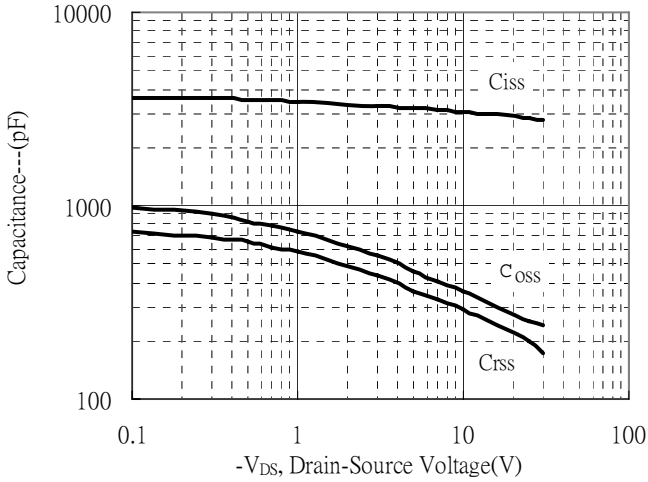

Threshold Voltage vs Junction Temperature

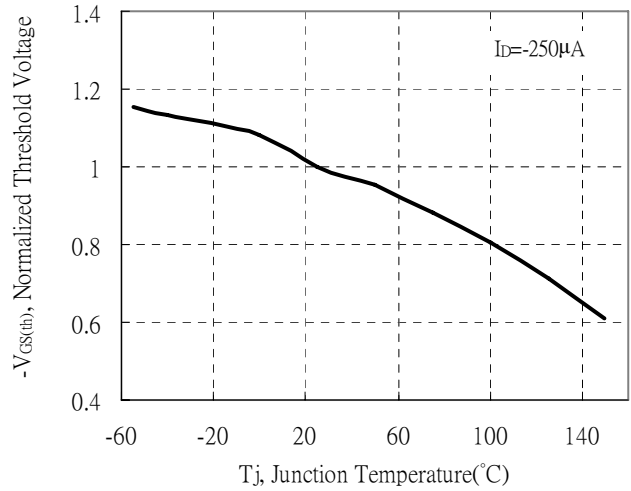

Forward Transfer Admittance vs Drain Current

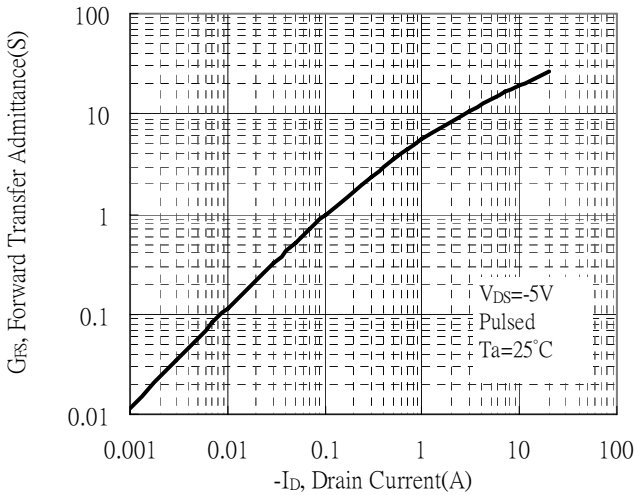

Gate Charge Characteristics

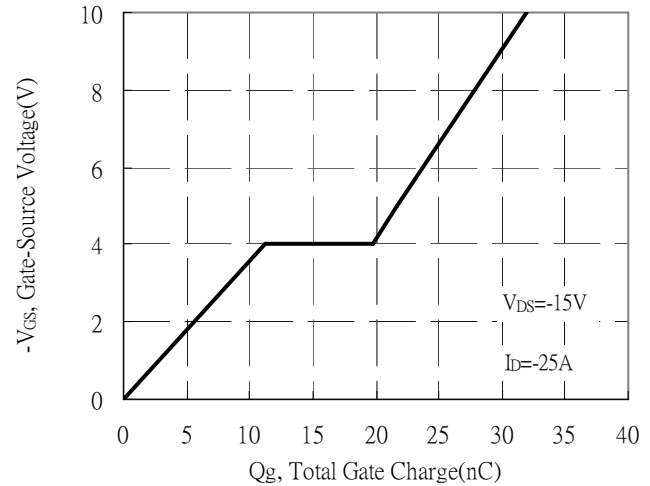

Maximum Safe Operating Area

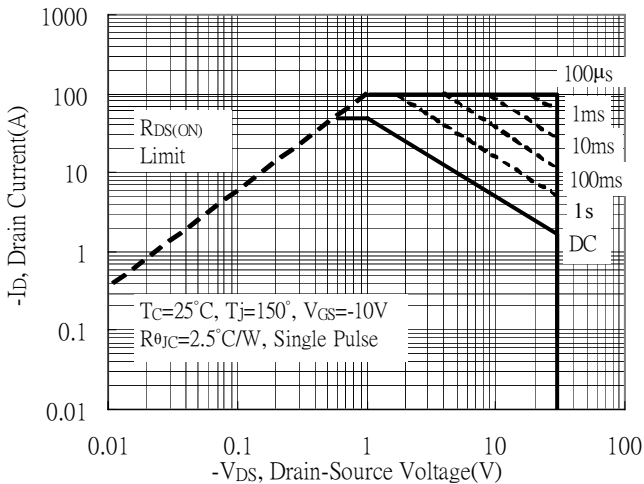

Maximum Drain Current vs Case Temperature

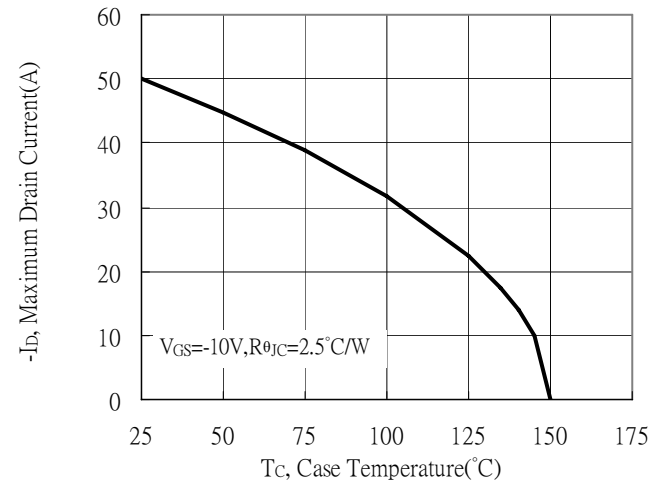



Typical Characteristics(Cont.)

Single Pulse Power Rating, Junction to Ambient
 (Note on page 2)

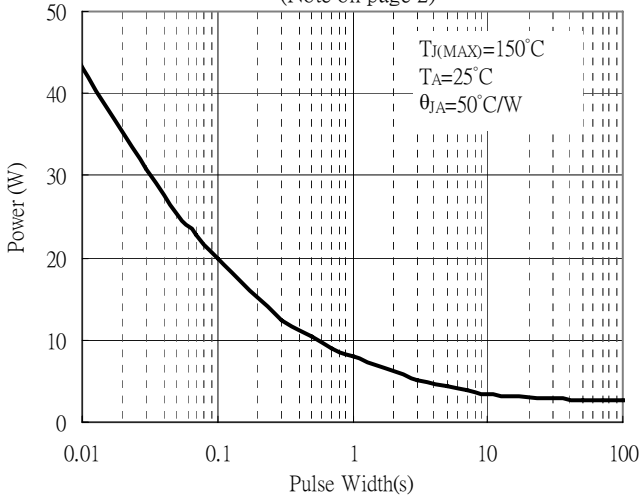

Power Derating Curve

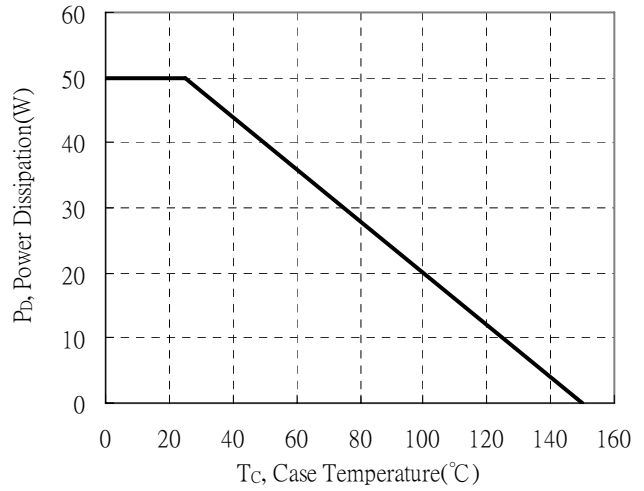

Transient Thermal Response Curves

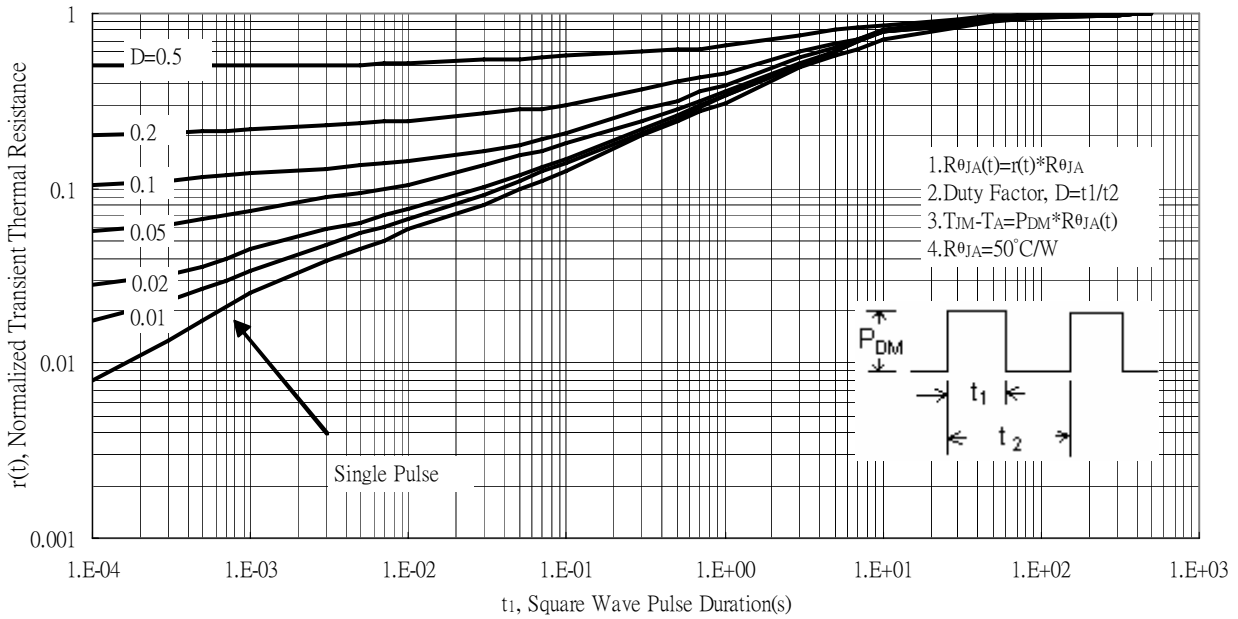

Recommended wave soldering condition

Product	Peak Temperature	Soldering Time
Pb-free devices	260 +0/-5 °C	5 +1/-1 seconds

Recommended temperature profile for IR reflow

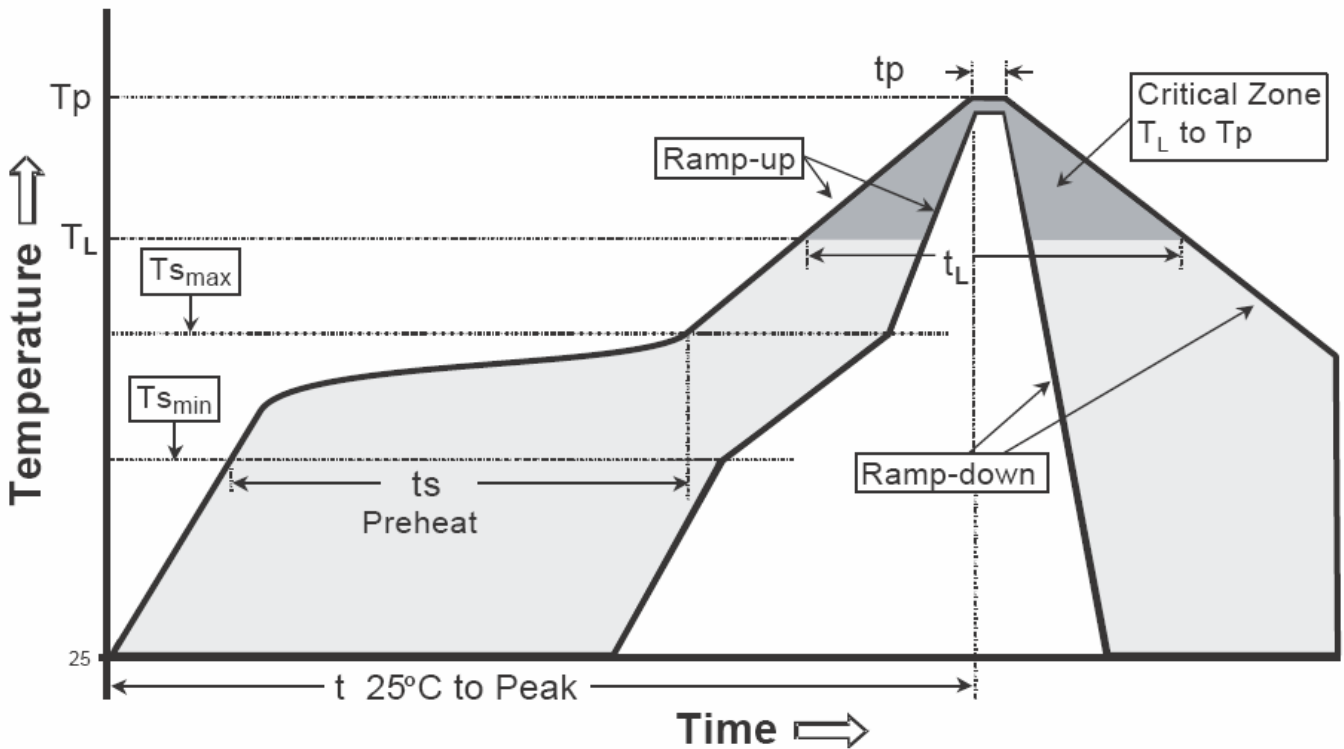

Profile feature	Sn-Pb eutectic Assembly	Pb-free Assembly
Average ramp-up rate (Tsmax to Tp)	3°C/second max.	3°C/second max.
Preheat		
-Temperature Min(Ts min)	100°C	150°C
-Temperature Max(Ts max)	150°C	200°C
-Time(ts min to ts max)	60-120 seconds	60-180 seconds
Time maintained above:		
-Temperature (Tl)	183°C	217°C
- Time (tl)	60-150 seconds	60-150 seconds
Peak Temperature(TP)	240 +0/-5 °C	260 +0/-5 °C
Time within 5°C of actual peak temperature(tp)	10-30 seconds	20-40 seconds
Ramp down rate	6°C/second max.	6°C/second max.
Time 25 °C to peak temperature	6 minutes max.	8 minutes max.

Note : All temperatures refer to topside of the package, measured on the package body surface.

TO-251AB Dimension

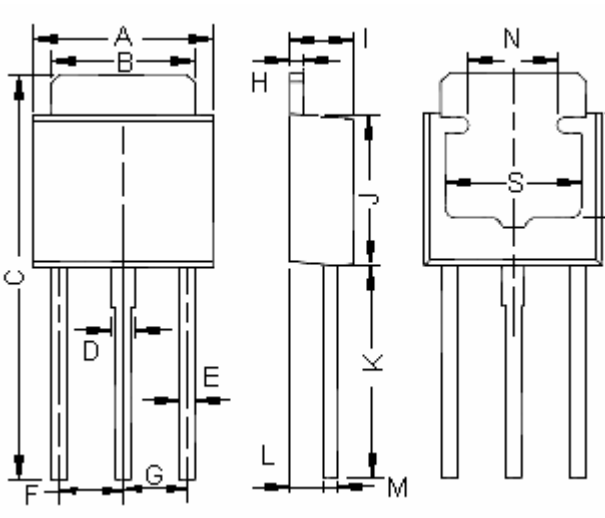

Marking:

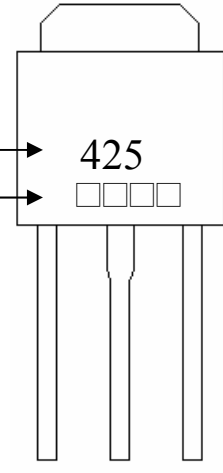

Product Name → 425
 Date Code → □□□□

Style: Pin 1.Gate 2.Drain 3.Source

3-Lead TO-251AB Plastic Package
 CYStek Package Code: I3

DIM	Inches		Millimeters		DIM	Inches		Millimeters	
	Min.	Max.	Min.	Max.		Min.	Max.	Min.	Max.
A	0.2500	0.2618	6.35	6.65	I	0.0866	0.0945	2.20	2.40
B	0.2047	0.2126	5.20	5.40	J	0.2126	0.2244	5.40	5.70
C	0.5709	0.5866	14.50	14.90	K	0.2992	0.3071	7.60	7.80
D	0.0276	0.0354	0.70	0.90	L	0.0453	0.0492	1.15	1.25
E	0.0199	0.0276	0.50	0.70	M	0.0169	0.0228	0.43	0.58
F	0.0886	0.0925	2.25	2.35	N	0.1181	REF	3.00	REF
G	0.0886	0.0925	2.25	2.35	S	0.1969	REF	5.00	REF
H	0.0169	0.0228	0.43	0.58	T	0.1496	REF	3.80	REF

Notes: 1.Controlling dimension: millimeters.
 2.Maximum lead thickness includes lead finish thickness, and minimum lead thickness is the minimum thickness of base material.
 3.If there is any question with packing specification or packing method, please contact your local CYStek sales office.

Material:

- Lead: Pure tin plated.
- Mold Compound: Epoxy resin family, flammability solid burning class: UL94V-0.

TO-251S Dimension

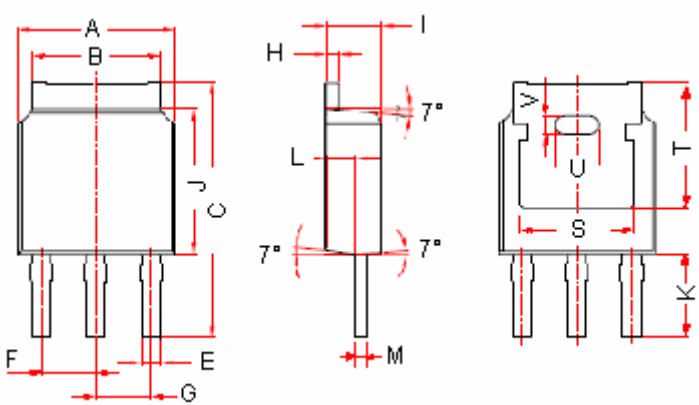

Marking :

Device Name → 425
 Date Code → □□□□

3-Lead TO-251S Plastic Package
 CYStek Package Code: I3

Style : Pin 1. Gate 2. Drain 3. Source

*: Typical

DIM	Inches		Millimeters		DIM	Inches		Millimeters	
	Min.	Max.	Min.	Max.		Min.	Max.	Min.	Max.
A	0.2559	0.2638	6.50	6.70	J	0.2362	0.2441	6.00	6.20
B	0.2020	0.2126	5.13	5.46	K	0.1299	0.1457	3.30	3.70
C	0.4094	0.4331	10.40	11.00	L	0.0358	0.0437	0.91	1.11
E	0.0280	0.0319	0.71	0.81	M	0.0181	0.0220	0.46	0.56
F	0.0858	0.0941	2.18	2.39	S	0.1902	REF	4.83	REF
G	0.0858	0.0941	2.18	2.39	T	0.2106	REF	5.35	REF
H	0.0181	0.0220	0.46	0.56	U	0.0701	REF	1.78	REF
I	0.0902	0.0937	2.29	2.38	V	0.0299	REF	0.76	REF

Notes: 1.Controlling dimension: inch.
 2.Maximum lead thickness includes lead finish thickness, and minimum lead thickness is the minimum thickness of base material.
 3.If there is any question with packing specification or packing method, please contact your local CYStek sales office.

Material:

- Lead: Pure tin plated
- Mold Compound: Epoxy resin family, flammability solid burning class: UL94V-0

Important Notice:

- All rights are reserved. Reproduction in whole or in part is prohibited without the prior written approval of CYStek.
- CYStek reserves the right to make changes to its products without notice.
- CYStek **semiconductor products are not warranted to be suitable for use in Life-Support Applications, or systems.**
- CYStek assumes no liability for any consequence of customer product design, infringement of patents, or application assistance.