

VPG
Series
DC/DC
Converters

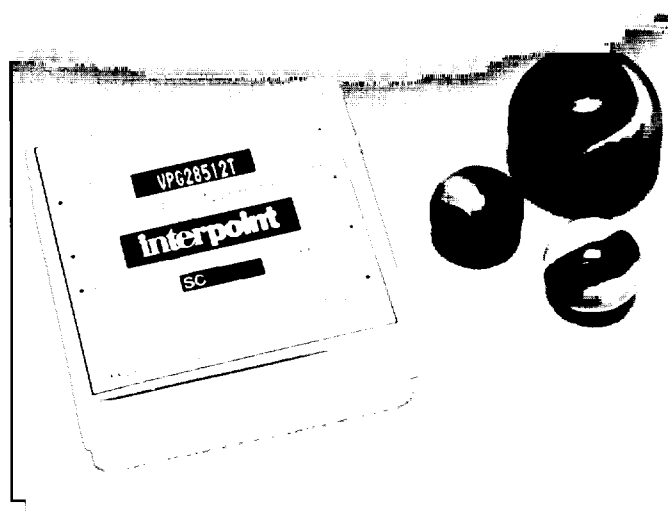

GENERAL DESCRIPTION

As members of Interpoint's Value/Performance product family, the VPG Series™ DC/DC converters feature up to 84% efficiency and 20 watts of output power. The input voltage ranges from 18 to 36 VDC on the 28 volt models and 36 to 72 VDC on the 48 volt models. Both the 28 and 48 volt models feature triple outputs of +5 and ±12 or +5 and ±15. Case operating temperatures of -40°C to +90°C exceed the usual commercial operating range, allowing use in a wider range of environments and applications.

CONVERTER DESIGN

VPG DC/DC converters use a single-ended forward topology with current mode pulse-width modulation. Switching frequency is 220 kHz. Input and output filtering significantly reduce noise and eliminate the need for external components.

PROTECTION FEATURES

The VPG Series includes several features to protect your system and the converter. The 28 volt models are transient protected up to 45 VDC for 100 milliseconds and the 48 volt models up to 85 VDC for 100 milliseconds. Short circuit protection from positive output to output common is provided by independent pulse-by-pulse current limiting. Thermal shutdown occurs at 105°C (case) to prevent damage from overheating. The converter will restart when the case temperature falls below 105°C. Input to output isolation of 700 VDC for the 28 volt models and 1544 VDC for the 48 volt models provides further protection.

REGULATION AND STABILITY

Line regulation is 0.4% and load regulation (minimum to maximum load) is less than 1% of the output voltage, depending on the model. Stability over 24 hours, with a 30 minute warm-up at full load, results in an output voltage drift of less than 0.02% for the ±12 or the ±15 output and less than 0.1% on the +5 output.

NOISE MANAGEMENT

Input ripple is 10 mA rms for the 28 volt models and 6 mA rms for the 48 volt models over a DC to 20 MHz bandwidth. Output noise is as low as 40 mV p-p for a DC to 20 MHz bandwidth. The input and output sections are fully isolated from each other. If the input and output sections will be connected, either at the converter or at another location, a 3.3 to 10 µF, low ESR, capacitor should be placed directly across the converter's output pins to reduce common mode switching noise.

ON/OFF FUNCTION

Further versatility is provided by the on/off function, which turns the converter off while keeping the input bulk capacitor fully charged. This prevents the large inrush current spike that occurs when cycling the input power. The on/off terminal (pin 1) can be driven with an open collector/drain or a relay and can be left floating if not used. When turned off, the unit draws 5 mA.

INPUT TO OUTPUT CAPACITANCE

The low input to output capacitance of 400 pF reduces ground loops often found in converters with higher capacitances.

SMALL PACKAGE

The 2.02 by 2.02 by 0.45 inch package weighs less than 3 ounces (85 grams) and is water washable. This five sided copper package is 0.017 inches (0.43 mm) thick, providing both EMI shielding and heat sinking. The case shield is tied to the input common (pin 2).

Note: The above paragraphs refer to typical specifications. See characteristics chart for detailed information.

interpoint

PREMIER POWER SOLUTIONS

VPG SERIES DC/DC CONVERTERS

- 20 watts output power
- Triple outputs, +5 and ±12, or +5 and ±15
- Efficiencies up to 84%
- -40°C to +90°C operating temperature
- On/Off function
- Low noise
- Over temperature, transient, and short circuit protection

No external components required for filtering or heat-sinking.

Five-sided copper package provides EMI shielding and heat sinking.

To order, call
1-800-822-8782

Interpoint Corporation
10301 Willows Road
P.O. Box 97005
Redmond, WA 98073-9705
TEL: (800) 822-8782
(206) 882-3100
FAX: (206) 882-1990
Internet: power@intp.com

IPONS051

CHARACTERISTICS: Tc = 25°C, nominal input voltage, full load unless otherwise specified.

Operating Temperature Range (Case)

- Full Power: -40°C to +90°C
- Absolute: -55°C to +100°C

Storage Temperature Range (Case)

- -55°C to +105°C

Thermal Impedance: in still air

- 9.5°C/watt per watt dissipated

Temperature Coefficient

- 50 ppm/°C, typical
- Main = 150 ppm/°C, max.
- Aux. = 200 ppm/°C, max.

Isolation: input to output

- 28 volt — 700 VDC
- 48 volt — 154 VDC

Weight

- Less than 85 grams, typical

Capacitance

- Input to output: 400 pF, typical

Conversion Frequency

- 220 kHz, typical

Start-up Time

- 10 milliseconds, typical

Stability: output voltage drift after a 30 minute warm-up

- Short term, 24 hours: < 0.05 %, typical

On/Off: referenced to input common

- Open circuit voltage = 2.5 VDC
- Output enabled = open or high (≥1.6 volts)
- Output disabled = low (≤0.7 volts), input current = 5 mA, typical

Resistance

- On/Off (pin 1): 20 k ohms

PARAMETER	CONDITIONS	VPG28512T			VPG28515T			VPG48512T			VPG48515T			UNITS
		MIN	TYP	MAX	MIN	TYP	MAX	MIN	TYP	MAX	MIN	TYP	MAX	
INPUT VOLTAGE	NORMAL	18	28	36	18	28	36	36	48	72	36	48	72	VDC
	TRANSIENT (100 ms)	—	—	45	—	—	45	—	—	85	—	—	85	
INPUT CURRENT	NO LOAD	—	10	—	—	10	—	—	8	—	—	8	—	mA
	FULL LOAD	—	850	—	—	850	—	—	510	—	—	510	—	
OUTPUT VOLTAGE	MAIN	4.925	5.0	5.075	4.925	5.0	5.075	4.925	5.0	5.075	4.925	5.0	5.075	VDC
	± AUX	11.70	12	12.30	14.70	15	15.30	11.70	12	12.30	14.70	15	15.30	
OUTPUT CURRENT	MAIN	600	—	2500	600	—	2500	600	—	2500	600	—	2500	mA
	± AUX	75	—	310	60	—	250	75	—	310	60	—	250	
OUTPUT POWER	TOTAL	—	—	20	—	—	20	—	—	20	—	—	20	W
EFFICIENCY	FULL LOAD	—	84	—	—	84	—	—	82	—	—	82	—	%
LINE REGULATION	MAIN	—	0.1	1.0	—	0.1	1.0	—	0.1	1.0	—	0.1	1.0	%
	± AUX	—	0.4	1.5	—	0.4	1.5	—	0.4	1.5	—	0.4	1.5	
LOAD REGULATION ¹	MAIN	—	<0.5	2.0	—	<0.5	2.0	—	<0.5	2.0	—	<0.5	2.0	%
	± AUX	—	<1.0	2.0	—	<1.0	2.0	—	<1.0	2.0	—	<1.0	2.0	
CROSS REGULATION ²	MAIN	—	1.0	—	—	1.0	—	—	1.0	—	—	1.0	—	%
	± AUX	—	5	—	—	5	—	—	5	—	—	5	—	
OUTPUT RIPPLE ³	MAIN	—	50	—	—	50	—	—	50	—	—	50	—	mV pp
	± AUX	—	40	—	—	40	—	—	40	—	—	40	—	
INPUT RIPPLE ⁴	0 TO 20 MHz	—	10	—	—	10	—	—	6	—	—	6	—	mA rms
TRANSIENT														
RECOVERY ⁵	MAIN	—	2	—	—	2	—	—	2	—	—	2	—	ms
	± AUX	—	0.5	—	—	0.5	—	—	0.5	—	—	0.5	—	
RESPONSE ⁶	MAIN	—	200	—	—	200	—	—	200	—	—	200	—	mV pp
	± AUX	—	130	—	—	140	—	—	130	—	—	140	—	

- Notes: 1. Output regulation is specified as simultaneously changing all outputs from minimum to maximum load.
 2. Cross regulation is the change in one output when only one other output load is changed from minimum to maximum.
 3. Measurement bandwidth is 0-20 MHz. To simulate normal PCB decoupling, a 0.01 µF ceramic capacitor and a 1 µF tantalum capacitor are placed one inch from the converter when measuring output noise.
 4. Input ripple is measured into a 10 µH source impedance.
 5. The time for the output to settle from a 50% to 75% step load change to within a 1% error band with a step rise time of 2 µs.
 6. The peak overshoot during a transient as defined in note 5.

TYPICAL PERFORMANCE CURVES

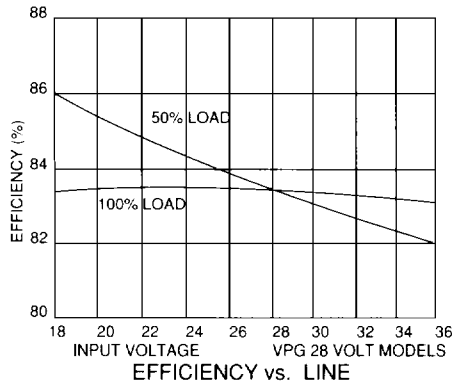

Figure 1

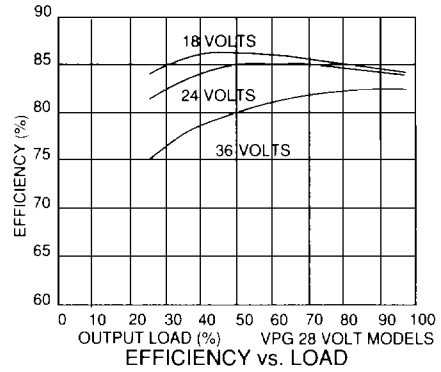

Figure 2

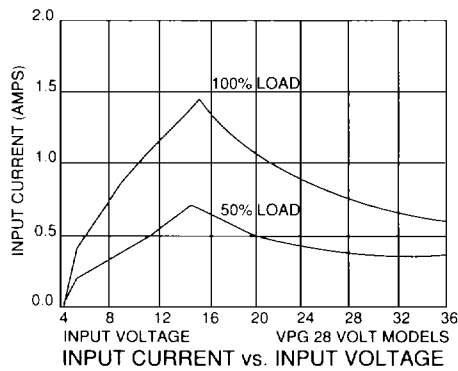

Figure 3

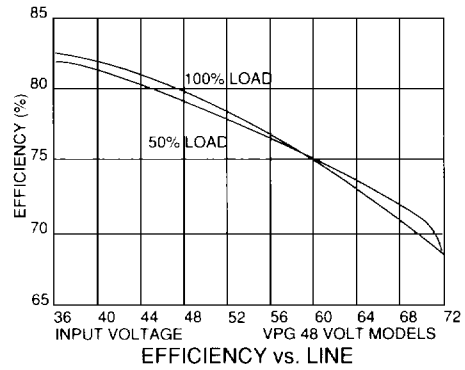

Figure 4

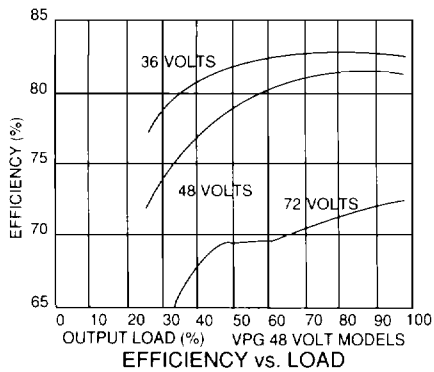

Figure 5

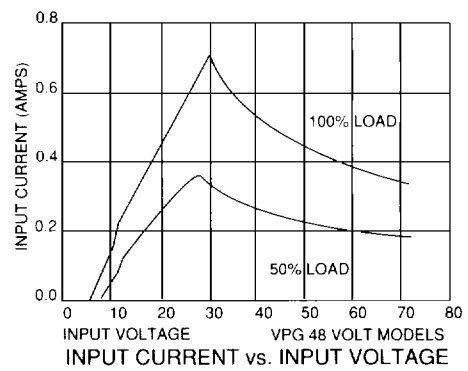

Figure 6

OPTIONAL ENVIRONMENTAL SCREENING

Environmental screening consists of the following procedures (Methods and Conditions refer to MIL-STD-202):

- 96 hours of burn-in at 85°C, per method 108.
- Mechanical shock per method 213, condition D.
- Temperature shock per method 107, condition A (modified).
- Final electrical test per Interpoint acceptance test procedure.

To order optional screening, add suffix -/ST to model number. Example: VPG28515T/ST. On unscreened parts, the screening code block is blank. On screened parts, the block is marked "ST."

BLOCK DIAGRAM

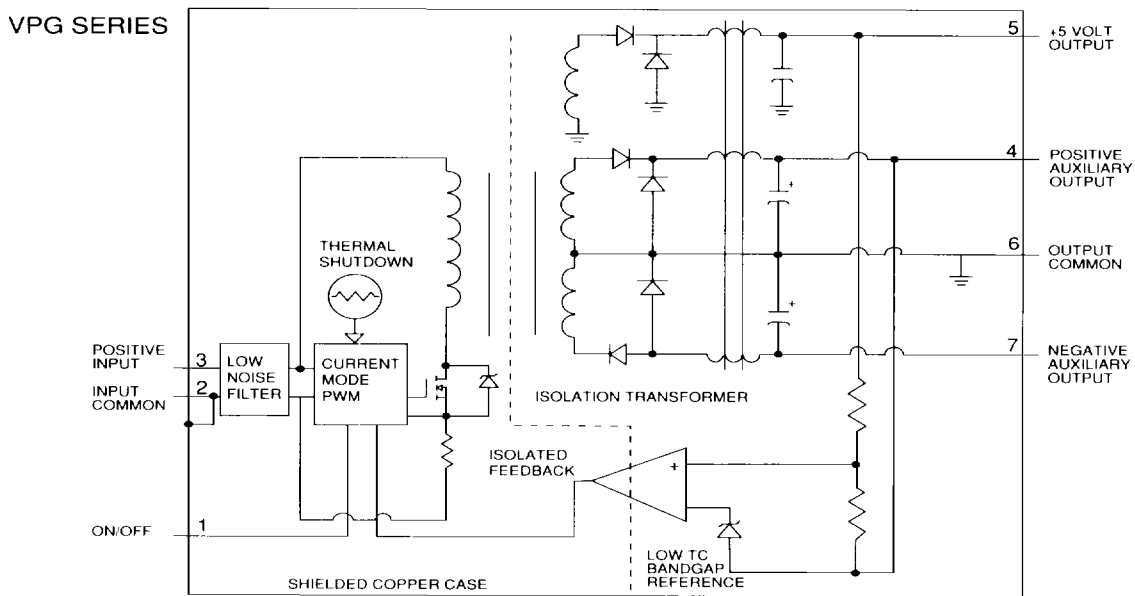

METAL AND EPOXY CASE

VPG SERIES CASE DRAWING
NOMINAL CASE DIMENSIONS IN INCHES (MM)
TOLERANCE X.XX ±0.02 (0.5), X.XXX ±0.005 (0.13)

Designation	Pin #
On/Off	1
Input common	2
Positive input	3
Positive auxiliary	4
+5 volt output	5
Output common	6
Negative auxiliary	7

Note: Case is connected to input common

TOP VIEW

