

### ●Features

- 1) High power class up to 4 to 5W.
- 2) The lineup of ultra-low resistance value : correspondence from 0.2mΩ
- 3) Excellent temperature coefficient.
- 4) Ideal for current detection under high current circuit.

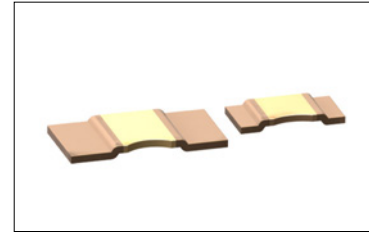

### ●Products List

Part No.	Size		Rated power (70°C)	Tolerance	Resistance range (mΩ)	Temperature coefficient (ppm / °C)	Operating Temperature Range (°C)
	(mm)	(inch)					
<b>PSR400</b>	10×5.2	3921	4W	J (±5%) G (±2%) F (±1%)	0.3,0.5	±175	-55 to +170
					1.0,2.0,3.0	±75	
<b>PSR500</b>	15×7.75	5931	5W	J (±5%) G (±2%) F (±1%)	0.2	±225	
					0.3,0.4,0.5	±150	
					1.0,2.0	±75	

\*(+20°C to +125°C)

### ●Chip Resistor Dimensions and Materials

(Unit : mm)

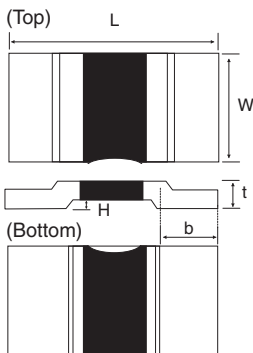

Part No.	(mm)	(inch)	L	W	H	b	Resistance	t	Material
<b>PSR400</b>	10×5.2	3921	10±0.3	5.2±0.3	0.5±0.1	2.0±0.6	0.3	1.85±0.15	Cu / Mn
							0.5	1.30±0.15	
							1.0	0.90±0.15	Ni / Cr
							2.0	1.15±0.15	
<b>PSR500</b>	15×7.75	5931	15±0.3	7.75±0.3	0.5±0.1	4.0±0.6	0.2	1.85±0.15	Cu / Mn
							0.3	1.40±0.15	
							0.4	1.15±0.15	
							0.5	1.05±0.15	Ni / Cr
							1.0	1.35±0.15	
							2.0	0.90±0.15	

### ●Derating Curve

When the ambient temperature exceeds 70°C, power dissipation must be adjusted according to the derating curves below.

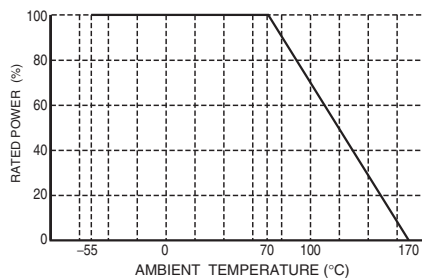

Design and specifications are subject to change without notice.  
Carefully check the specification sheet supplied with the product before using or ordering it.

●Characteristics

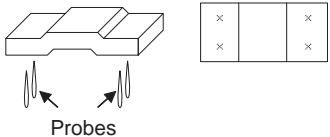
Test Items	Guaranteed Value	Test Conditions
	Resistor Type	
Resistance	F : ±1% G : ±2% J : ±5%	Measuring method : 2probe per terminal 
Variation of resistance with temperature	See P1	Measurement : +20/+125
Overload	±0.5%	Rated power×5,5s
Solderability	A new uniform coating of minimum of 95% of the surface being immersed an no soldering da a	Rosin- Ethanol solution(25% weight) Soldering condition : 245±5°C Duration of immersion : 2.0±0.5s.
Resistance to soldering heat	±1.0% No remarkable abnormality on the appearance.	Soldering condition : 260±5°C Duration of immersion : 10±1s
Rapid change of temperature	±1.0%	Test temp. : -55°C to +155°C 5cycle
Damp heat, steady state	±0.5%	40°C, 93%RH (Relative Humidity) Test time : 1,000h to 1,048h
Endurance at 70°C	±1.0%	70°C Rated power 1.5h : ON – 0.5h : OFF Test time : 1,000h to 1,048h
Endurance at 170°C	±1.0%	70°C Test time : 1,000h to 1,048h
Component Solvent Resistance	±0.5%	23±5°C Solvent : 2-propanol
Bend strength of the end face plating	Without open	-

Compliance Standard(s) : IEC60115-8  
JISC 5201-1

●Solder Conditions

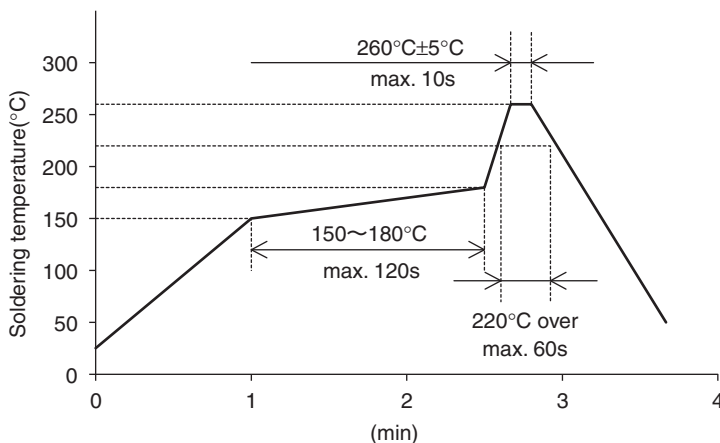

Recommended solder profile			
Reflow			
Temperature(°C)	260	220	150 to 180
Time(s)	Peak 10s Max.	60s	120s

<Reference data>

●Characteristics

Type	Resistance Value (mΩ)	Thermal resistivity of product (°C /W)	Thermal EMF (μV/°C)	Inductance (nH)
PSR400	0.3	4.5	2μV/°C Max.	< 3nH
	0.5	8		
	1	15		
	2	16		
	3	24		
PSR500	0.2	3		
	0.3	4.5		
	0.4	7		
	0.5	8		
	1	8		
	2	16		

●Variation of resistance with temperature (Reference temperature is 20°C)

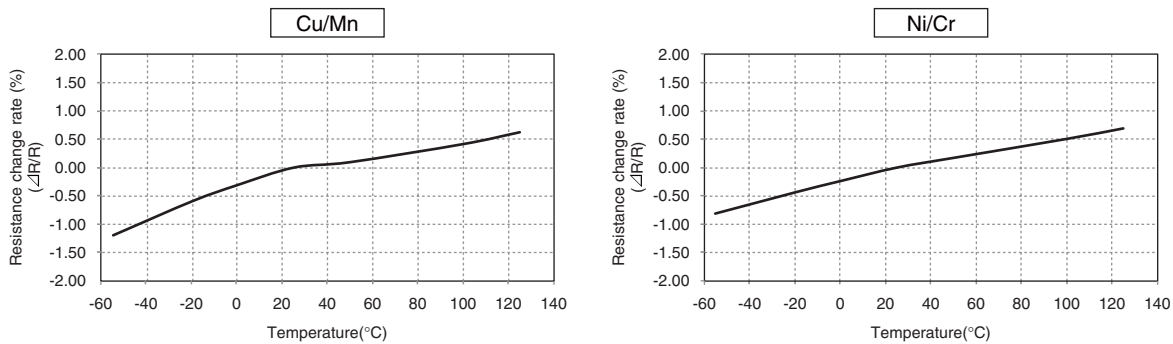

●Endurance (170°C with no load)

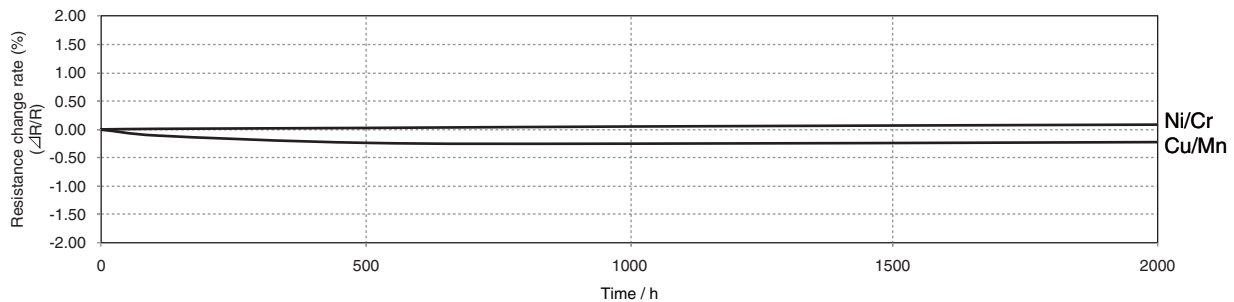

●Surface Temp Rise (Ta=25°C)

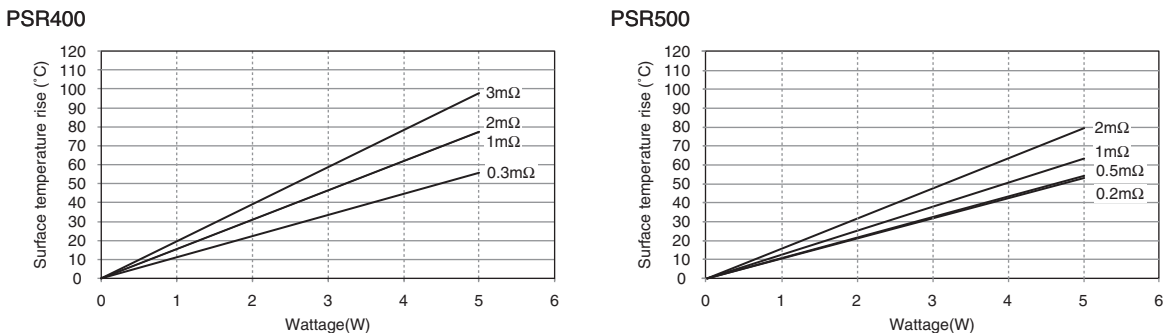

Measurement condition of this data was taken out from board created under our regulation. Product with highest temperature was selected for the measurement.

Please contact us about test board and test conditions.

●Land Pattern

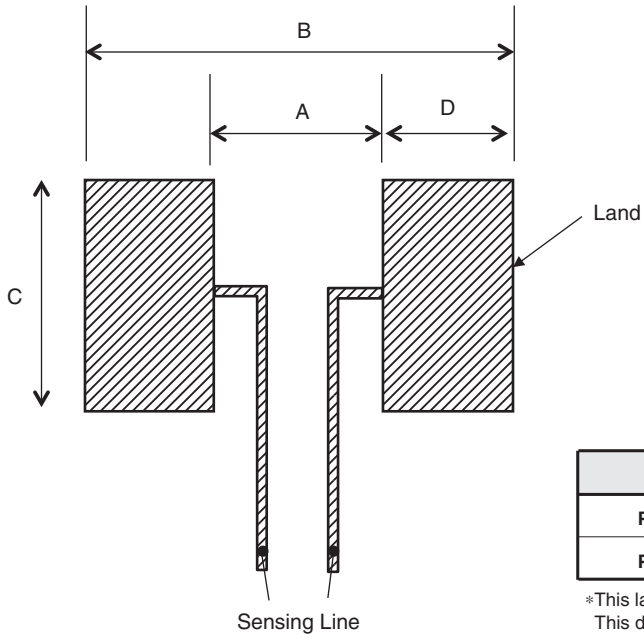

Type	A	B	C	D
PSR500	5.60	16.00	8.75	5.20
PSR400		11.00	6.20	2.70

\*This land pattern is only for standard pattern.  
This does not guarantee the characteristics of the parts

●Part Number Description



Part No.
<b>PSR</b> (Ultra low ohmic metal plate / High power type shunt Resistors)

Size (mm [inch])
400 (1.0×5.2 [3921]) 500 (15×7.75 [5931])

Tolerance
F 1%
G 2%
J 5%

Special part code
C 0.2mΩ
D 0.3mΩ
E 0.4mΩ
F 0.5mΩ
H 1.0mΩ
J 2.0mΩ
L 3.0mΩ

Nominal Resistance		
Resistance code, 3 or 4 digits.		
tolerance	Resistance code	
F,G	: 4 digits	
J	: 3 digits	
Resistance	Tolerance	
	J	F,G
0.2	0L2	0L20
0.3	0L3	0L30
0.4	0L4	0L40
0.5	0L5	0L50
1.0	1L0	1L00
2.0	2L0	2L00
3.0	3L0	3L00

Packaging Specifications code			
Part No.	Code	Packaging specifications	Basic ordering unit (pcs)
<b>PSR400</b>	ITQ	Embossed tape (8mm Pitch)	3,000
<b>PSR500</b>	HTQ	Embossed tape (12mm Pitch)	2,000

●Tape Dimensions

■Embossed Tape

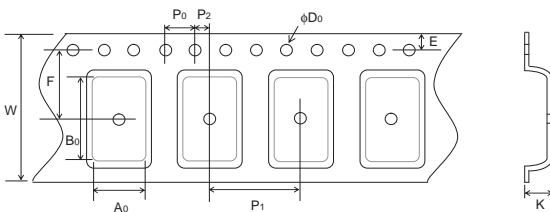

(Unit : mm)

Part No.	W	F	E	A0	B0
<b>PSR400</b>	16.0±0.2	7.5±0.1	1.75±0.1	5.7±0.2	10.5±0.2
<b>PSR500</b>	24.0±0.2	11.5±0.1	1.75±0.1	8.3±0.2	15.6±0.2

Part No.	D0	P0	P1	P2	K
<b>PSR400</b>	φ1.5 <sup>+0.1</sup> <sub>0</sub>	4.0±0.1	8.0±0.1	2.0±0.1	2.3±0.1
<b>PSR500</b>	φ1.5 <sup>+0.1</sup> <sub>0</sub>	4.0±0.1	12.0±0.1	2.0±0.1	2.3±0.1

●Reel Dimensions

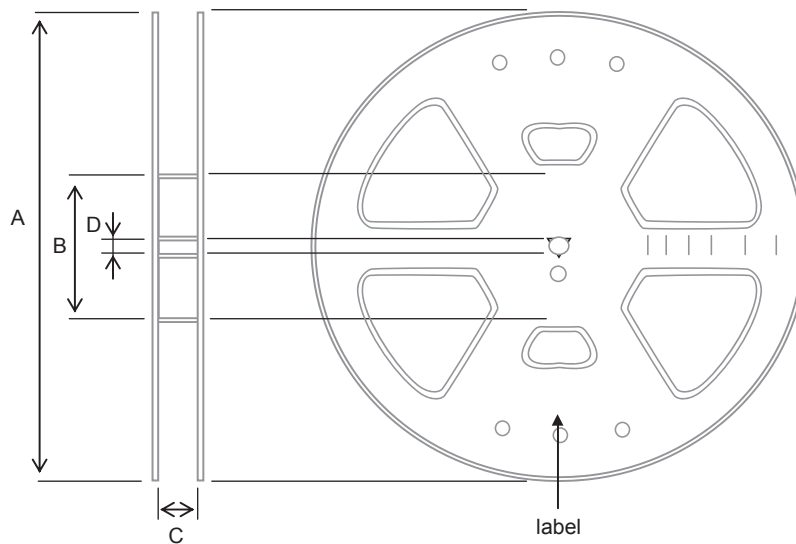

ACCORDING TO EIAJ ET-7200A  
(Unit : mm)

Part No.	A	B	C	D
<b>PSR400</b>	φ330±2.00	φ100±1.00	φ17.4±1.0	φ13.00±0.20
<b>PSR500</b>			φ25.4±1.0	

## Notes

- 1) The information contained herein is subject to change without notice.
- 2) Before you use our Products, please contact our sales representative and verify the latest specifications :
- 3) Although ROHM is continuously working to improve product reliability and quality, semiconductors can break down and malfunction due to various factors.  
Therefore, in order to prevent personal injury or fire arising from failure, please take safety measures such as complying with the derating characteristics, implementing redundant and fire prevention designs, and utilizing backups and fail-safe procedures. ROHM shall have no responsibility for any damages arising out of the use of our Products beyond the rating specified by ROHM.
- 4) Examples of application circuits, circuit constants and any other information contained herein are provided only to illustrate the standard usage and operations of the Products. The peripheral conditions must be taken into account when designing circuits for mass production.
- 5) The technical information specified herein is intended only to show the typical functions of and examples of application circuits for the Products. ROHM does not grant you, explicitly or implicitly, any license to use or exercise intellectual property or other rights held by ROHM or any other parties. ROHM shall have no responsibility whatsoever for any dispute arising out of the use of such technical information.
- 6) The Products are intended for use in general electronic equipment (i.e. AV/OA devices, communication, consumer systems, gaming/entertainment sets) as well as the applications indicated in this document.
- 7) The Products specified in this document are not designed to be radiation tolerant.
- 8) For use of our Products in applications requiring a high degree of reliability (as exemplified below), please contact and consult with a ROHM representative : transportation equipment (i.e. cars, ships, trains), primary communication equipment, traffic lights, fire/crime prevention, safety equipment, medical systems, servers, solar cells, and power transmission systems.
- 9) Do not use our Products in applications requiring extremely high reliability, such as aerospace equipment, nuclear power control systems, and submarine repeaters.
- 10) ROHM shall have no responsibility for any damages or injury arising from non-compliance with the recommended usage conditions and specifications contained herein.
- 11) ROHM has used reasonable care to ensure the accuracy of the information contained in this document. However, ROHM does not warrant that such information is error-free, and ROHM shall have no responsibility for any damages arising from any inaccuracy or misprint of such information.
- 12) Please use the Products in accordance with any applicable environmental laws and regulations, such as the RoHS Directive. For more details, including RoHS compatibility, please contact a ROHM sales office. ROHM shall have no responsibility for any damages or losses resulting from non-compliance with any applicable laws or regulations.
- 13) When providing our Products and technologies contained in this document to other countries, you must abide by the procedures and provisions stipulated in all applicable export laws and regulations, including without limitation the US Export Administration Regulations and the Foreign Exchange and Foreign Trade Act.
- 14) This document, in part or in whole, may not be reprinted or reproduced without prior consent of ROHM.



Thank you for your accessing to ROHM product informations.  
More detail product informations and catalogs are available, please contact us.

## ROHM Customer Support System

<http://www.rohm.com/contact/>