



**TAOS Inc.**

**is now**

**ams AG**

The technical content of this TAOS datasheet is still valid.

**Contact information:**

**Headquarters:**

ams AG

Tobelbaderstrasse 30

8141 Unterpremstaetten, Austria

Tel: +43 (0) 3136 500 0

e-Mail: [ams\\_sales@ams.com](mailto:ams_sales@ams.com)

Please visit our website at [www.ams.com](http://www.ams.com)

- **Monolithic Silicon IC Containing Photodiode, Operational Amplifier, and Feedback Components**
- **Converts Light Intensity to a Voltage**
- **High Irradiance Responsivity, Typically**
  - 64 mV/( $\mu\text{W}/\text{cm}^2$ ) at  $\lambda_p = 640 \text{ nm}$  (TSL250RD)
  - 58 mV/( $\mu\text{W}/\text{cm}^2$ ) at  $\lambda_p = 940 \text{ nm}$  (TSL260RD)
- **Single Voltage Supply Operation**
- **Low Dark (Offset) Voltage . . . 10 mV Max**
- **Low Supply Current . . . 1.1 mA Typical**
- **Wide Supply-Voltage Range . . . 2.7 V to 5.5 V**
- **Low-Profile Surface-Mount Package:**
  - Clear Plastic for TSL250RD and TSL251RD
  - Visible Light-Cutoff Filter Plastic for TSL260RD and TSL261RD
- **Lead (Pb) Free and RoHS Compliant Package**

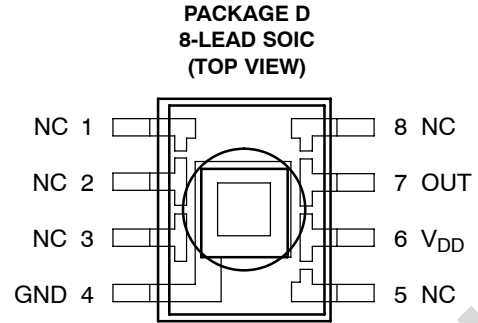

## Description

The TSL250RD, TSL251RD, TSL260RD, and TSL261RD are light-to-voltage optical sensors, each combining a photodiode and a transimpedance amplifier on a single monolithic IC. The TSL250RD and TSL260RD have an equivalent feedback resistance of 16 M $\Omega$  and a photodiode measuring 1 square mm. The TSL251RD and TSL261RD have an equivalent feedback resistance of 8 M $\Omega$  and a photodiode measuring 0.5 square mm. Output voltage is directly proportional to the light intensity (irradiance) on the photodiode. These devices have improved amplifier offset-voltage stability and low power consumption.

## Functional Block Diagram

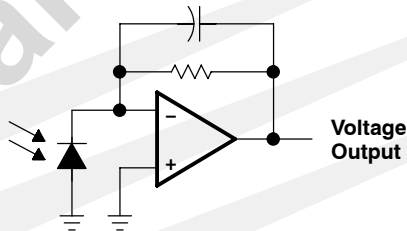

## Terminal Functions

| TERMINAL NAME   | NO. | DESCRIPTION   |
|-----------------|-----|---|
| GND             | 4   | Ground (substrate). All voltages are referenced to GND. |
| OUT             | 7   | Output voltage.   |
| V <sub>DD</sub> | 6   | Supply voltage.   |

# TSL250RD, TSL251RD, TSL260RD, TSL261RD LIGHT-TO-VOLTAGE OPTICAL SENSORS

TAOS050K – OCTOBER 2007

## Absolute Maximum Ratings over operating free-air temperature range (unless otherwise noted)<sup>†</sup>

|   |               |
|---|---------------|
| Supply voltage, $V_{DD}$ (see Note 1) .....   | 6 V           |
| Output current, $I_O$ .....   | $\pm 10$ mA   |
| Duration of short-circuit current at (or below) 25°C (see Note 2) .....                     | 5 s           |
| Operating free-air temperature range, $T_A$ .....   | -25°C to 85°C |
| Storage temperature range, $T_{stg}$ .....  | -25°C to 85°C |
| Solder conditions in accordance with JEDEC J-STD-020A, maximum temperature (see Note 3) ... | 260°C         |

<sup>†</sup> Stresses beyond those listed under “absolute maximum ratings” may cause permanent damage to the device. These are stress ratings only, and functional operation of the device at these or any other conditions beyond those indicated under “recommended operating conditions” is not implied. Exposure to absolute-maximum-rated conditions for extended periods may affect device reliability.

- NOTES: 1. All voltages are with respect to GND.  
 2. Output may be shorted to supply.  
 3. The device may be hand soldered provided that heat is applied only to the solder pad and no contact is made between the tip of the solder iron and the device lead. The maximum time heat should be applied to the device is 5 seconds.

## Recommended Operating Conditions

|                                       | MIN | NOM | MAX | UNIT |
|---------------------------------------|-----|-----|-----|------|
| Supply voltage, $V_{DD}$              | 2.7 |     | 5.5 | V    |
| Operating free-air temperature, $T_A$ | 0   |     | 70  | °C   |

## Electrical Characteristics at $V_{DD} = 5$ V, $T_A = 25^\circ\text{C}$ , $R_L = 10$ k $\Omega$ (unless otherwise noted) (see Notes 3, 4, 5, and 6)

| PARAMETER   | TEST CONDITIONS  | $\lambda_p = 640$ nm |     |     |          |     |     | $\lambda_p = 940$ nm |     |     |          |     |     | UNIT                                 |
|---|--|----------------------|-----|-----|----------|-----|-----|----------------------|-----|-----|----------|-----|-----|--------------------------------------|
|   |  | TSL250RD             |     |     | TSL251RD |     |     | TSL260RD             |     |     | TSL261RD |     |     |                                      |
|   |  | MIN                  | TYP | MAX | MIN      | TYP | MAX | MIN                  | TYP | MAX | MIN      | TYP | MAX |                                      |
| $V_D$ Dark voltage                                  | $E_e = 0$  | 0                    | 5   | 10  | 0        | 5   | 10  | 0                    | 5   | 10  | 0        | 5   | 10  | mV                                   |
| $V_{OM}$ Maximum output voltage                     | $V_{DD} = 4.5$ V   | 3                    | 3.3 |     | 3        | 3.3 |     | 3                    | 3.3 |     | 3        | 3.3 |     | V                                    |
| $V_O$ Output voltage                                | $E_e = 31$ $\mu\text{W}/\text{cm}^2$                                   | 1.5                  | 2   | 2.5 |          |     |     |                      |     |     |          |     |     | V                                    |
|   | $E_e = 124$ $\mu\text{W}/\text{cm}^2$                                  |                      |     |     | 1.5      | 2   | 2.5 |                      |     |     |          |     |     |                                      |
|   | $E_e = 34$ $\mu\text{W}/\text{cm}^2$                                   |                      |     |     |          |     |     | 1                    | 2   | 3   |          |     |     |                                      |
|   | $E_e = 132$ $\mu\text{W}/\text{cm}^2$                                  |                      |     |     |          |     |     |                      |     |     | 1        | 2   | 3   |                                      |
| $R_e$ Irradiance responsivity                       | See Note 7   |                      | 64  |     |          | 16  |     |                      | 58  |     |          | 15  |     | mV/<br>( $\mu\text{W}/\text{cm}^2$ ) |
| Temperature coefficient of output voltage ( $V_O$ ) | $V_O = 2$ V @ 25°C,<br>$T_A = 0^\circ\text{C}$ to 70°C<br>(see Note 8) |                      | 2   |     |          | 2   |     |                      | 8   |     |          | 8   |     | mV/°C                                |
|   |  |                      | 0.1 |     |          | 0.1 |     |                      | 0.4 |     |          | 0.4 |     | %/°C                                 |
| $I_{DD}$ Supply current                             | $E_e = 31$ $\mu\text{W}/\text{cm}^2$                                   |                      | 1.1 | 1.7 |          |     |     |                      |     |     |          |     |     | mA                                   |
|   | $E_e = 124$ $\mu\text{W}/\text{cm}^2$                                  |                      |     |     |          | 1.1 | 1.7 |                      |     |     |          |     |     |                                      |
|   | $E_e = 34$ $\mu\text{W}/\text{cm}^2$                                   |                      |     |     |          |     |     |                      | 1.1 | 1.7 |          |     |     |                                      |
|   | $E_e = 132$ $\mu\text{W}/\text{cm}^2$                                  |                      |     |     |          |     |     |                      |     |     |          | 1.1 | 1.7 |                                      |

- NOTES: 4. Measurements are made with  $R_L = 10$  k $\Omega$  between output and ground.  
 5. Optical measurements are made using small-angle incident radiation from an LED optical source.  
 6. The 640 nm input irradiance  $E_e$  is supplied by an AlInGaP LED with peak wavelength  $\lambda_p = 640$  nm.  
 7. The 940 nm input irradiance  $E_e$  is supplied by a GaAs LED with peak wavelength  $\lambda_p = 940$  nm.  
 8. Irradiance responsivity is characterized over the range  $V_O = V_D$  to 3 V. The best-fit straight line of Output Voltage  $V_O$  versus irradiance  $E_e$  over this range will typically have a positive extrapolated  $V_O$  value for  $E_e = 0$ .  
 9. The temperature coefficient of output voltage measurement is made by adjusting irradiance such that  $V_O$  is approximately 2 V at 25°C and then with irradiance held constant, measuring  $V_O$  while varying the temperature between 0°C and 70°C.

Dynamic Characteristics at  $V_{DD} = 5\text{ V}$ ,  $T_A = 25^\circ\text{C}$ ,  $R_L = 10\text{ k}\Omega$  (unless otherwise noted) (see Figure 1)

| PARAMETER | TEST CONDITIONS   | $\lambda_p = 640\text{ nm}$ |     |     |          |     |     | $\lambda_p = 940\text{ nm}$ |     |     |          |     |     | UNIT                                     |
|-----------|---|-----------------------------|-----|-----|----------|-----|-----|-----------------------------|-----|-----|----------|-----|-----|--|
|           |   | TSL250RD                    |     |     | TSL251RD |     |     | TSL260RD                    |     |     | TSL261RD |     |     |  |
|           |   | MIN                         | TYP | MAX | MIN      | TYP | MAX | MIN                         | TYP | MAX | MIN      | TYP | MAX |  |
| $t_r$     | Output pulse rise time<br>$V_{O(\text{peak})} = 2\text{ V}$ | 260                         |     |     | 70       |     |     | 260                         |     |     | 70       |     |     | $\mu\text{s}$                            |
| $t_f$     | Output pulse fall time<br>$V_{O(\text{peak})} = 2\text{ V}$ | 260                         |     |     | 70       |     |     | 260                         |     |     | 70       |     |     | $\mu\text{s}$                            |
| $V_n$     | Output noise voltage<br>$E_e = 0$ ,<br>$f = 1000\text{ Hz}$ | 0.8                         |     |     | 0.7      |     |     | 0.8                         |     |     | 0.7      |     |     | $\frac{\mu\text{V}}{\sqrt{(\text{Hz})}}$ |

PARAMETER MEASUREMENT INFORMATION

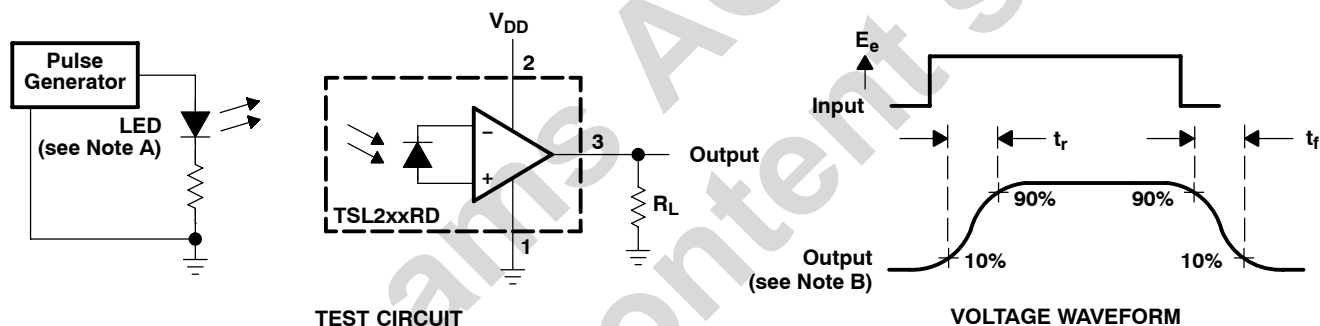

NOTES: A. The input irradiance is supplied by a pulsed light-emitting diode with  $t_r < 1\ \mu\text{s}$ ,  $t_f < 1\ \mu\text{s}$ .

B. The output waveform is monitored on an oscilloscope with the following characteristics:  $t_r < 100\text{ ns}$ ,  $Z_i \geq 1\text{ M}\Omega$ ,  $C_i \leq 20\text{ pF}$ .

Figure 1. Switching Times

# TSL250RD, TSL251RD, TSL260RD, TSL261RD LIGHT-TO-VOLTAGE OPTICAL SENSORS

TAOS050K – OCTOBER 2007

## TYPICAL CHARACTERISTICS

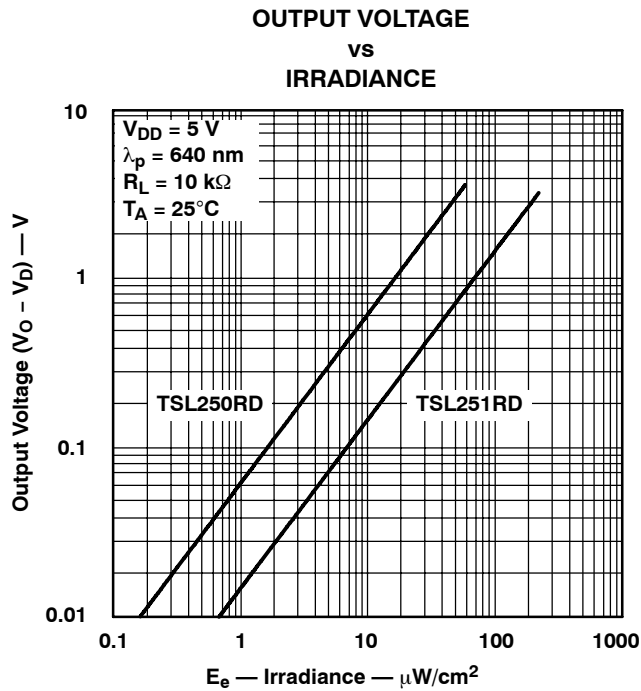

Figure 2

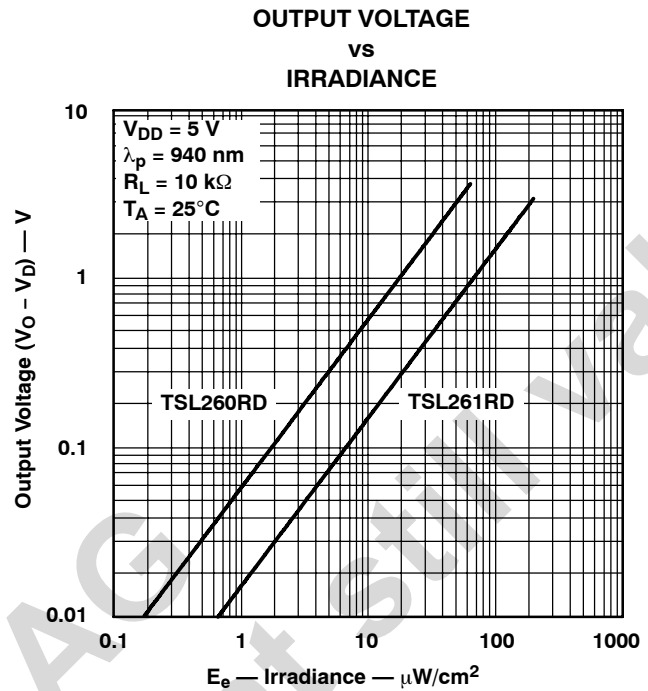

Figure 3

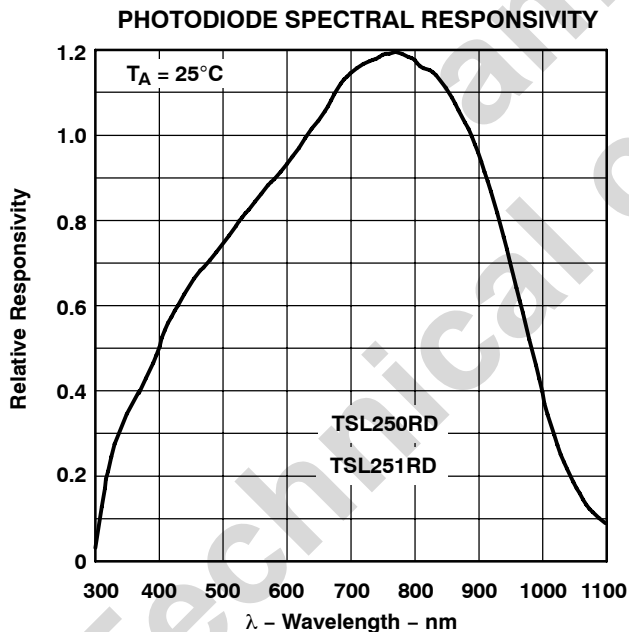

Figure 4

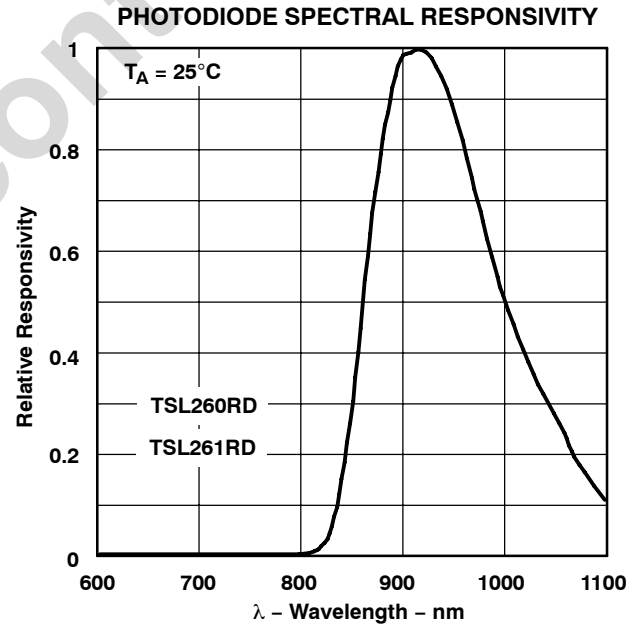

Figure 5

TYPICAL CHARACTERISTICS

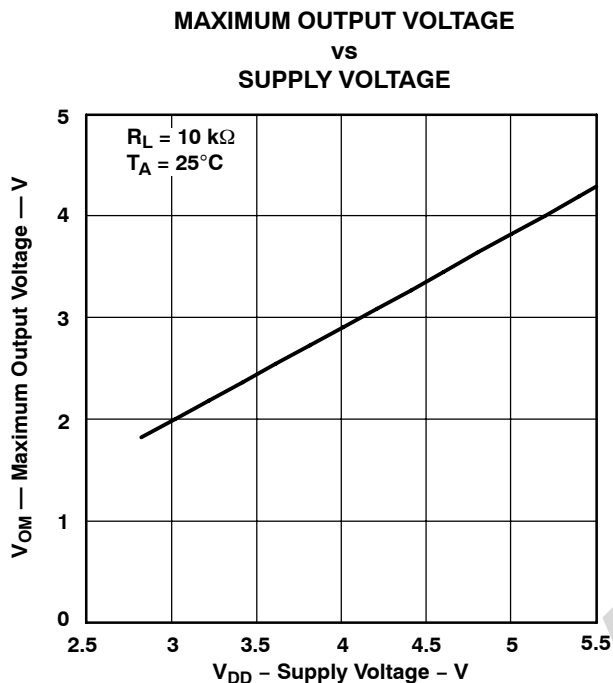

Figure 6

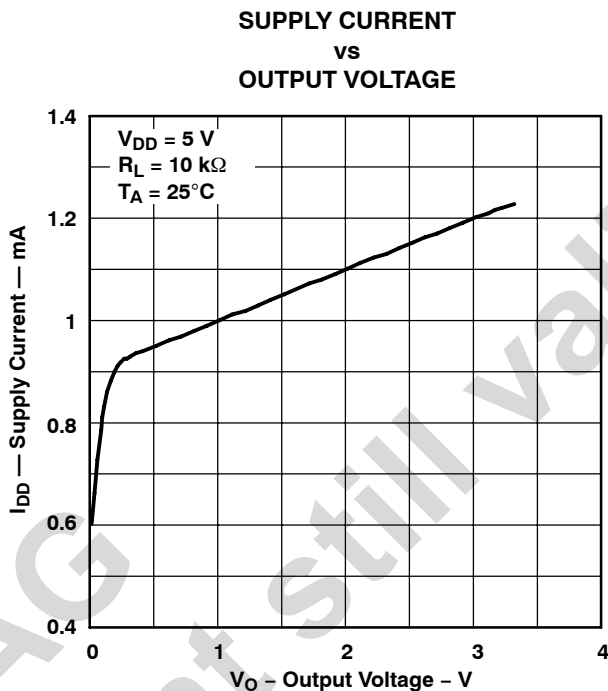

Figure 7

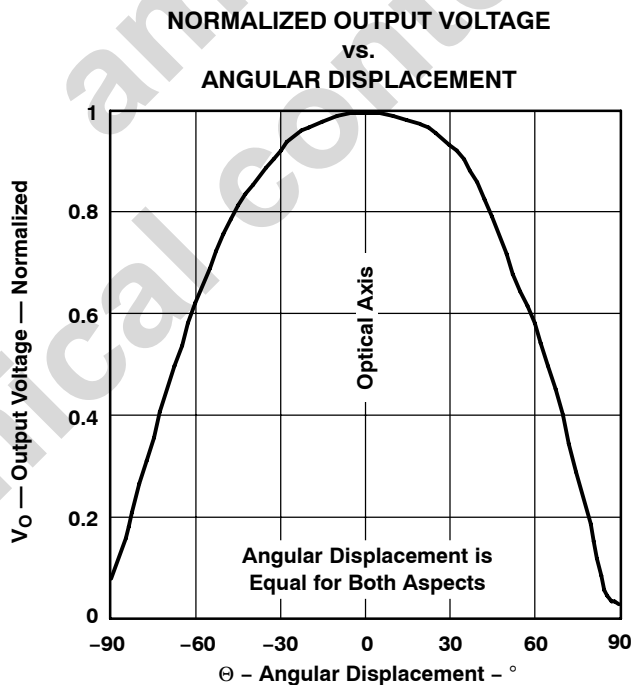

Figure 8

# TSL250RD, TSL251RD, TSL260RD, TSL261RD LIGHT-TO-VOLTAGE OPTICAL SENSORS

TAOS050K – OCTOBER 2007

## APPLICATION INFORMATION

### Power Supply Considerations

For optimum device performance, power-supply lines should be decoupled by a 0.01- $\mu$ F to 0.1- $\mu$ F capacitor with short leads connected between VDD and GND mounted close to the device package.

### Device Operational Details

The voltage developed at the output pin (OUT) is given by:

$$V_O = V_D + (R_e)(E_e)$$

where:

- $V_O$  is the output voltage
- $V_D$  is the output voltage for dark condition ( $E_e = 0$ )
- $R_e$  is the device responsivity for a given wavelength of light given in  $mV/(\mu W/cm^2)$
- $E_e$  is the incident irradiance in  $\mu W/cm^2$

$V_D$  is a fixed offset voltage resulting primarily from the input offset voltage of the internal op amp. As shown in the equation above, this voltage represents a constant, light-independent term in the total output voltage  $V_O$ . At low light levels, this offset voltage can be a significant percentage of  $V_O$ . For optimum performance of any given device over the full output range, the value of  $V_D$  should be measured (in the absence of light) and later subtracted from all subsequent light measurements (see Figures 2 and 3).

### PCB Pad Layout

Suggested PCB pad layout guidelines for the D package is shown in Figure 9.

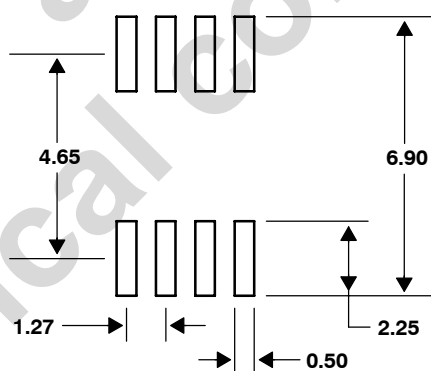

- NOTES: A. All linear dimensions are in millimeters.  
B. This drawing is subject to change without notice.

Figure 9. Suggested D Package PCB Layout

MECHANICAL DATA

This SOIC package consists of an integrated circuit mounted on a lead frame and encapsulated with an electrically nonconductive clear plastic compound. The photodiode area is typically 1.02 mm<sup>2</sup> for the TSL250RD and TSL260RD, and is typically 0.514 mm<sup>2</sup> for the TSL251RD and TSL261RD.

PACKAGE D

PLASTIC SMALL-OUTLINE

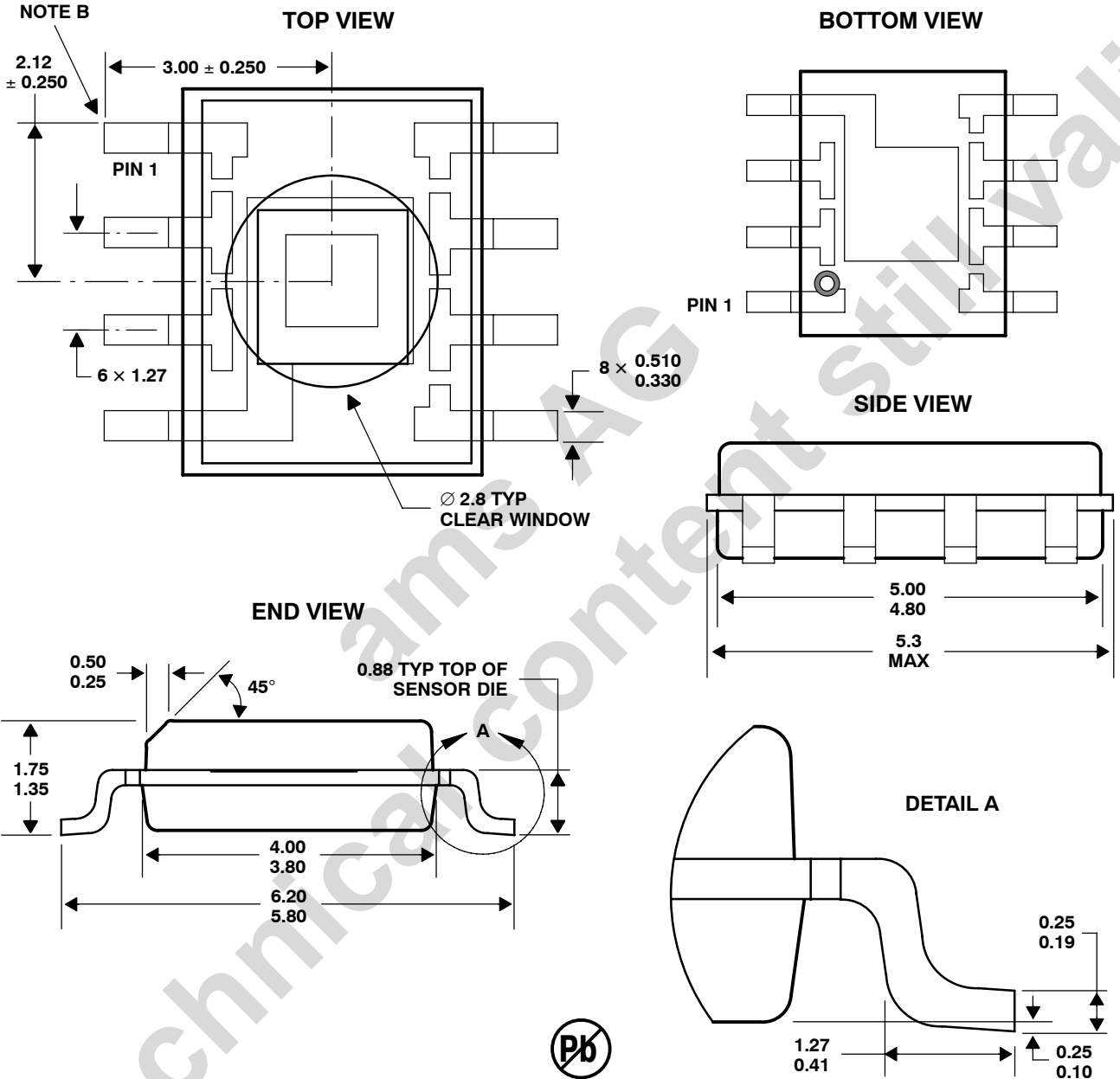

- NOTES: A. All linear dimensions are in millimeters.  
 B. The center of the photo-active area is referenced to the upper left corner tip of the lead frame (Pin 1).  
 C. Package is molded with an electrically nonconductive clear plastic compound having an index of refraction of 1.55.  
 D. This drawing is subject to change without notice.

Figure 10. Package D — Plastic Small Outline IC Packaging Configuration



# TSL250RD, TSL251RD, TSL260RD, TSL261RD LIGHT-TO-VOLTAGE OPTICAL SENSORS

TAOS050K – OCTOBER 2007

## MECHANICAL DATA

### SIDE VIEW

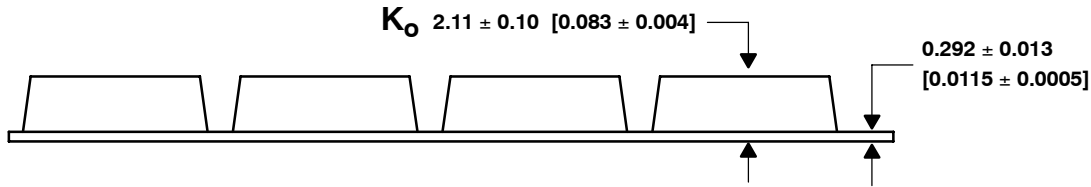

### TOP VIEW

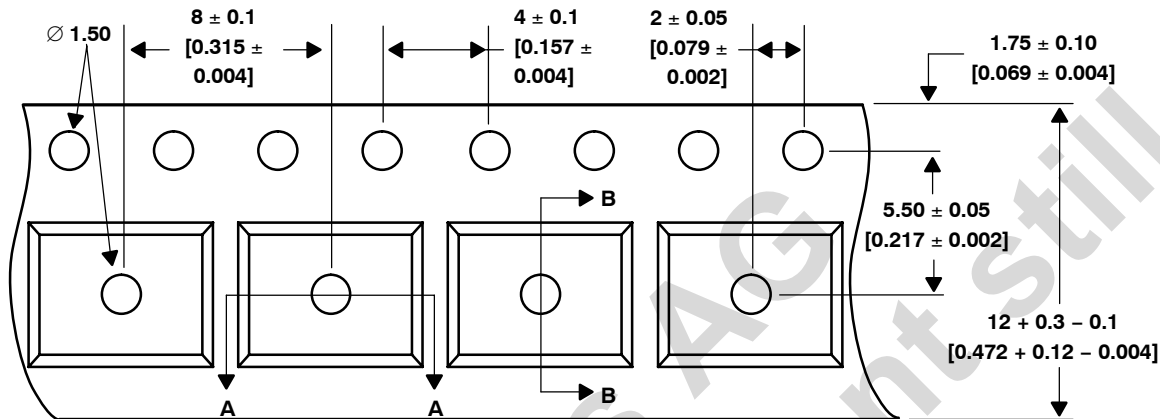

### END VIEW



### DETAIL A

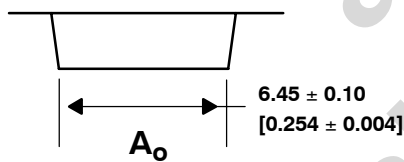

### DETAIL B

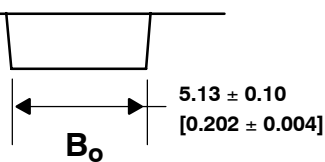

- NOTES: A. All linear dimensions are in millimeters [inches].  
 B. The dimensions on this drawing are for illustrative purposes only. Dimensions of an actual carrier may vary slightly.  
 C. Symbols on drawing  $A_o$ ,  $B_o$ , and  $K_o$  are defined in ANSI EIA Standard 481-B 2001.  
 D. Each reel is 178 millimeters in diameter and contains 1000 parts.  
 E. TAOS packaging tape and reel conform to the requirements of EIA Standard 481-B.  
 F. This drawing is subject to change without notice.

Figure 11. Package D Carrier Tape

**MANUFACTURING INFORMATION**

The Plastic Small Outline IC package (D) has been tested and has demonstrated an ability to be reflow soldered to a PCB substrate.

The solder reflow profile describes the expected maximum heat exposure of components during the solder reflow process of product on a PCB. Temperature is measured on top of component. The component should be limited to a maximum of three passes through this solder reflow profile.

**Table 1. TSL2xxRD Solder Reflow Profile**

| PARAMETER                                  | REFERENCE  | TSL2xxRD           |
|--|------------|--------------------|
| Average temperature gradient in preheating |            | 2.5°C/sec          |
| Soak time                                  | $t_{soak}$ | 2 to 3 minutes     |
| Time above 217°C                           | $t_1$      | Max 60 sec         |
| Time above 230°C                           | $t_2$      | Max 50 sec         |
| Time above $T_{peak} - 10^\circ\text{C}$   | $t_3$      | Max 10 sec         |
| Peak temperature in reflow                 | $T_{peak}$ | 260° C (-0°C/+5°C) |
| Temperature gradient in cooling            |            | Max -5°C/sec       |

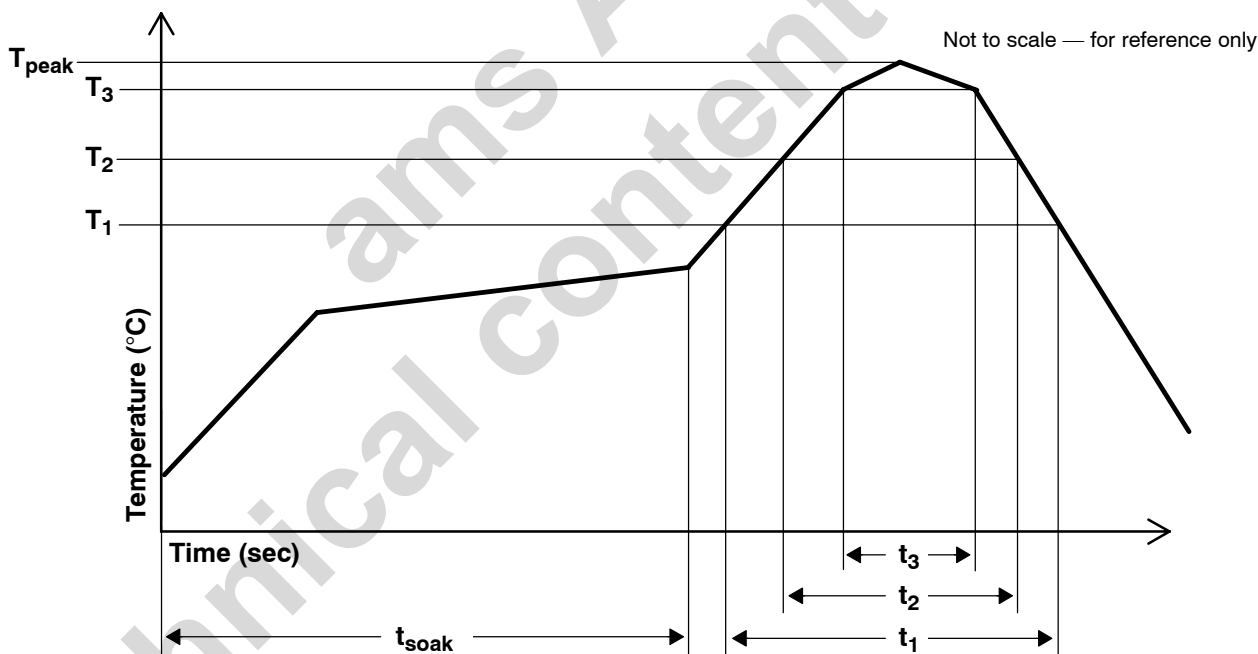

**Figure 12. TSL2xxRD Solder Reflow Profile Graph**

# TSL250RD, TSL251RD, TSL260RD, TSL261RD LIGHT-TO-VOLTAGE OPTICAL SENSORS

TAOS050K – OCTOBER 2007

---

## Moisture Sensitivity

Optical characteristics of the device can be adversely affected during the soldering process by the release and vaporization of moisture that has been previously absorbed into the package molding compound. To prevent these adverse conditions, all devices shipped in carrier tape have been pre-baked and shipped in a sealed moisture-barrier bag. No further action is necessary if these devices are processed through solder reflow within 24 hours of the seal being broken on the moisture-barrier bag.

However, for all devices shipped in tubes or if the seal on the moisture barrier bag has been broken for 24 hours or longer, it is recommended that the following procedures be used to ensure the package molding compound contains the smallest amount of absorbed moisture possible.

### ***For devices shipped in tubes:***

1. Remove devices from tubes
2. Bake devices for 4 hours, at 90°C
3. After cooling, load devices back into tubes
4. Perform solder reflow within 24 hours after bake

Bake only a quantity of devices that can be processed through solder reflow in 24 hours. Devices can be re-baked for 4 hours, at 90°C for a cumulative total of 12 hours (3 bakes for 4 hours at 90°C).

### ***For devices shipped in carrier tape:***

1. Bake devices for 4 hours, at 90°C in the tape
2. Perform solder reflow within 24 hours after bake

Bake only a quantity of devices that can be processed through solder reflow in 24 hours. Devices can be re-baked for 4 hours in tape, at 90°C for a cumulative total of 12 hours (3 bakes for 4 hours at 90°C).

**PRODUCTION DATA** — information in this document is current at publication date. Products conform to specifications in accordance with the terms of Texas Advanced Optoelectronic Solutions, Inc. standard warranty. Production processing does not necessarily include testing of all parameters.

### **LEAD-FREE (Pb-FREE) and GREEN STATEMENT**

**Pb-Free (RoHS)** TAOS' terms *Lead-Free* or *Pb-Free* mean semiconductor products that are compatible with the current RoHS requirements for all 6 substances, including the requirement that lead not exceed 0.1% by weight in homogeneous materials. Where designed to be soldered at high temperatures, TAOS Pb-Free products are suitable for use in specified lead-free processes.

**Green (RoHS & no Sb/Br)** TAOS defines *Green* to mean Pb-Free (RoHS compatible), and free of Bromine (Br) and Antimony (Sb) based flame retardants (Br or Sb do not exceed 0.1% by weight in homogeneous material).

**Important Information and Disclaimer** The information provided in this statement represents TAOS' knowledge and belief as of the date that it is provided. TAOS bases its knowledge and belief on information provided by third parties, and makes no representation or warranty as to the accuracy of such information. Efforts are underway to better integrate information from third parties. TAOS has taken and continues to take reasonable steps to provide representative and accurate information but may not have conducted destructive testing or chemical analysis on incoming materials and chemicals. TAOS and TAOS suppliers consider certain information to be proprietary, and thus CAS numbers and other limited information may not be available for release.

### **NOTICE**

Texas Advanced Optoelectronic Solutions, Inc. (TAOS) reserves the right to make changes to the products contained in this document to improve performance or for any other purpose, or to discontinue them without notice. Customers are advised to contact TAOS to obtain the latest product information before placing orders or designing TAOS products into systems.

TAOS assumes no responsibility for the use of any products or circuits described in this document or customer product design, conveys no license, either expressed or implied, under any patent or other right, and makes no representation that the circuits are free of patent infringement. TAOS further makes no claim as to the suitability of its products for any particular purpose, nor does TAOS assume any liability arising out of the use of any product or circuit, and specifically disclaims any and all liability, including without limitation consequential or incidental damages.

TEXAS ADVANCED OPTOELECTRONIC SOLUTIONS, INC. PRODUCTS ARE NOT DESIGNED OR INTENDED FOR USE IN CRITICAL APPLICATIONS IN WHICH THE FAILURE OR MALFUNCTION OF THE TAOS PRODUCT MAY RESULT IN PERSONAL INJURY OR DEATH. USE OF TAOS PRODUCTS IN LIFE SUPPORT SYSTEMS IS EXPRESSLY UNAUTHORIZED AND ANY SUCH USE BY A CUSTOMER IS COMPLETELY AT THE CUSTOMER'S RISK.

LUMENOLOGY, TAOS, the TAOS logo, and Texas Advanced Optoelectronic Solutions are registered trademarks of Texas Advanced Optoelectronic Solutions Incorporated.

**TSL250RD, TSL251RD, TSL260RD, TSL261RD  
LIGHT-TO-VOLTAGE OPTICAL SENSORS**

TAOS050K – OCTOBER 2007

---

ams AG  
Technical content still valid