



# PRODUCT SPECIFICATION

REV A January 2011

Oscilent Controlled Document

Ordering Code / Part Number	Product Description
835-IF92.4M-03A	92.4MHz IF SAW Filter 3.95 MHz Bandwidth

## Specification Contents

- o Mechanical Dimensions
- o Test Circuit
- o Maximum Ratings
- o Electrical Specification
- o Frequency Response
- o Smith Chart
- o VSWR

## Notes

- o Electrostatic Sensitive Device (ESD) 
- o Avoid excessive ultrasonic exposure
- o Solderability compatible with JEDEC J-STD-020C Pb-free process, 260°C peak reflow temperature
- o This product complies with EU directive 2002/95/EC (RoHS compliance)





## Mechanical Dimensions (mm)

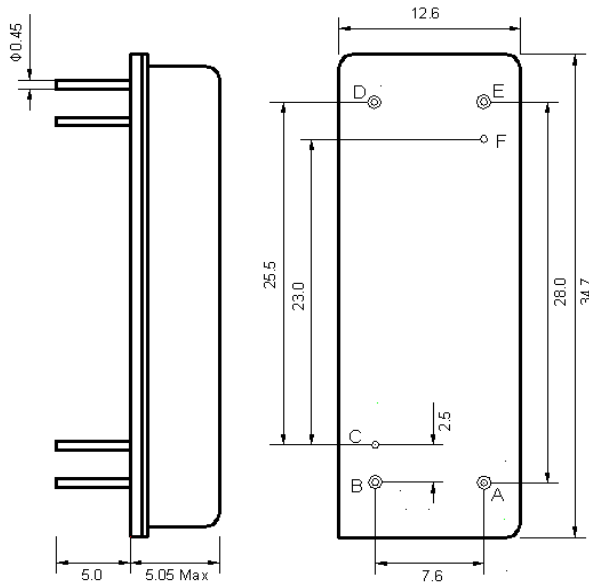

Pin Description	
B, C, D, F	Ground
A	In
E	Out

## Test Circuit

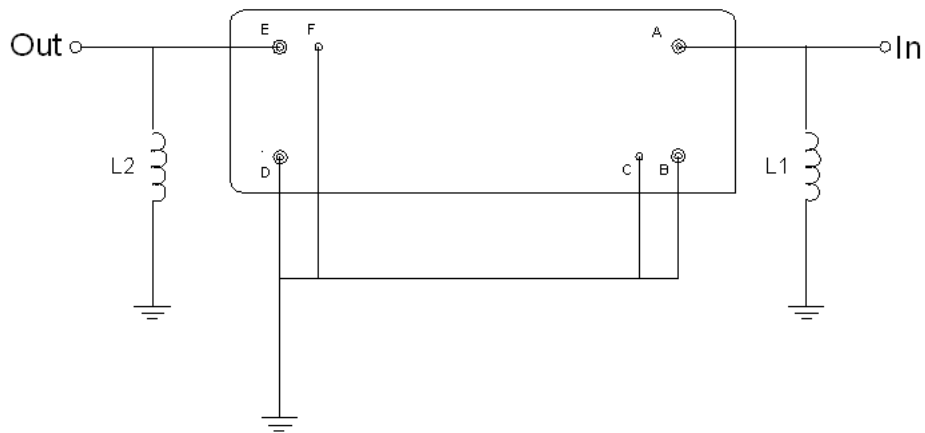

Test Fixture & Values	
Input	L1=82nH
Output	L2=82nH
Source/Load Impedance	50 Ω



## Maximum Ratings

Parameters Description	Unit	Minimum	Typical	Maximum
Operating Temperature Range	°C	-	25	-
Storage Temperature Range	°C	-40	-	80
Maximum DC Voltage	V	-	-	10
Maximum Input Power	dBm	-	-	10
Source Impedance (single ended) <sup>(1)</sup>	Ω	-	50	-
Load Impedance (single ended) <sup>(1)</sup>	Ω	-	50	-

Notes: With Matching Network (Ref. Testing Environment Circuit as shown above).

Those impedances could be modified with different impedance values and/or structures, if necessary.

## Electrical Specification

Parameters Description	Unit	Minimum	Typical	Maximum
Center Frequency (Fo)	MHz	-	92.4	-
Insertion Loss at Fo	dB	-	23.5	25.0
Group Delay Variation (Fo±1.92MHz)	ns	-	111	120
Absolute Delay Time at Fo	us	-	5.68	-
Temperature Coefficient	ppm/°C	-	-20	-
Amplitude Ripple (Fo±1.92MHz)	dB	-	0.92	-
Bandwidth at -1.0dB	MHz	3.84	3.95	-
Bandwidth at -3.0dB	MHz	-	4.13	-
Bandwidth at -40dB	MHz	-	4.87	-
Bandwidth at -50dB	MHz	-	4.93	5.0
Ultimate Rejection	-	50	55	-



## Frequency Response

### Bandwidth at -1.0 dB

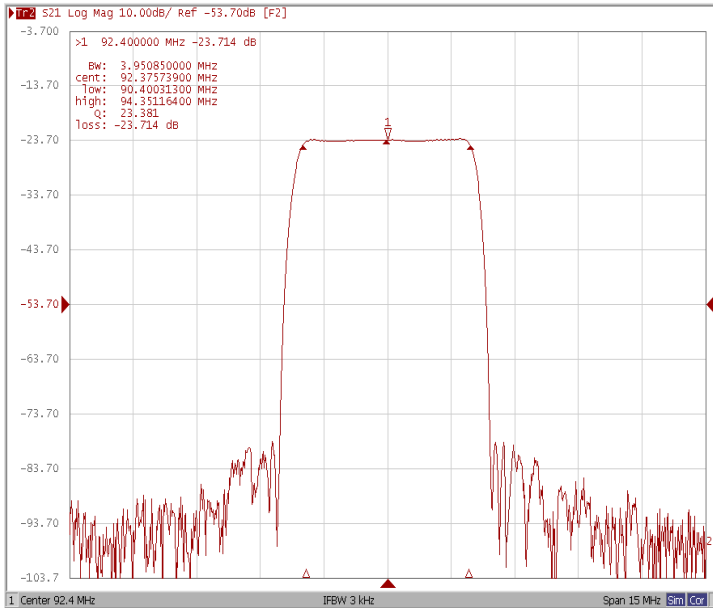

### Bandwidth at -3.0 dB

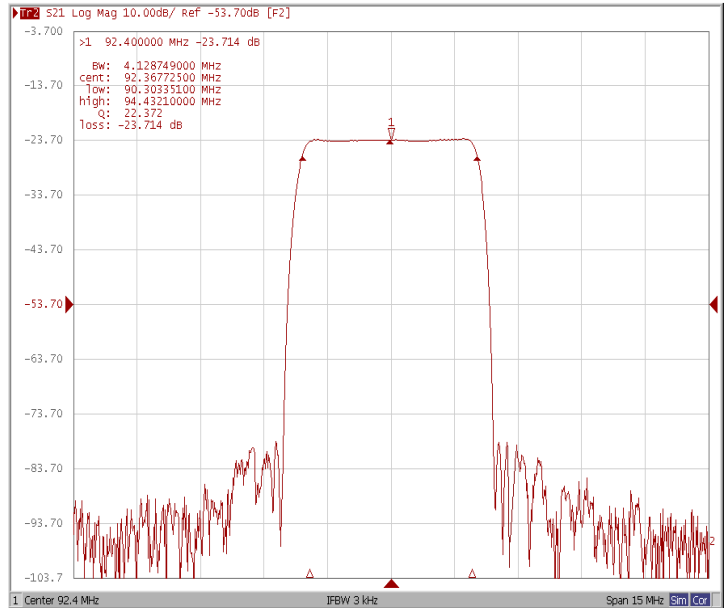

### Bandwidth at -40.0 dB

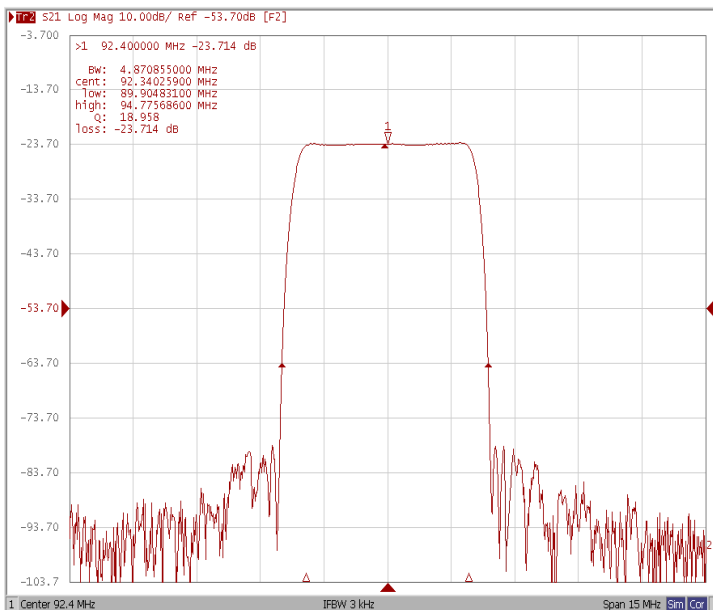

### Bandwidth at -50.0 dB

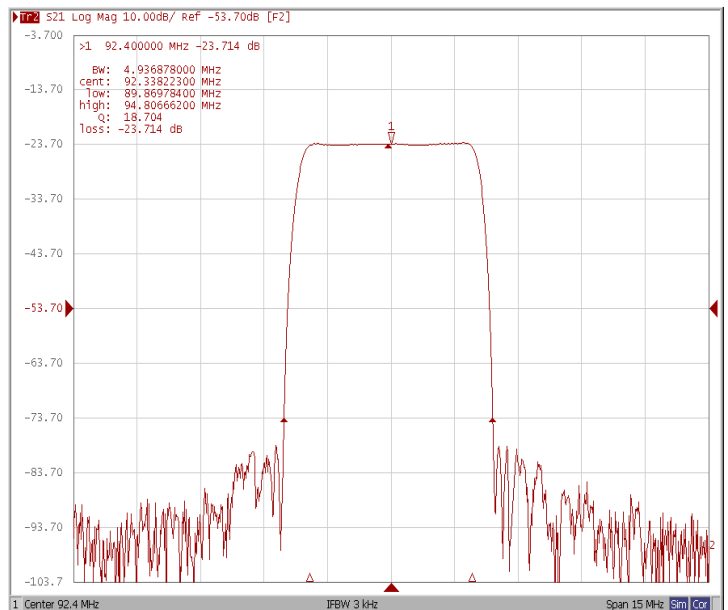



### Ripple Variation Fo±1.92MHz

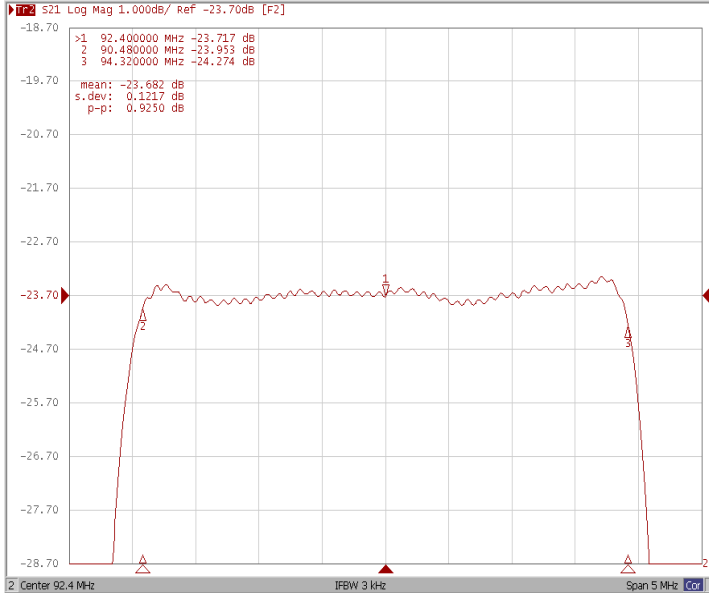

### Group Delay Variation Fo±1.92MHz

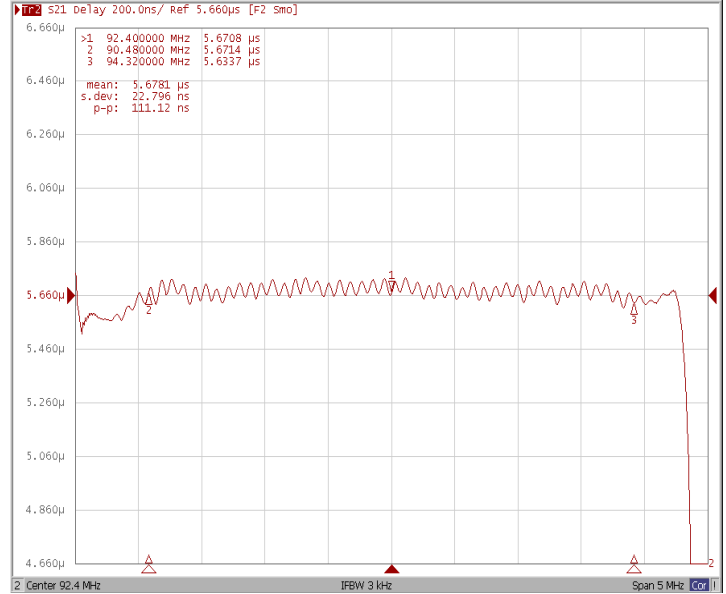

### Smith Chart

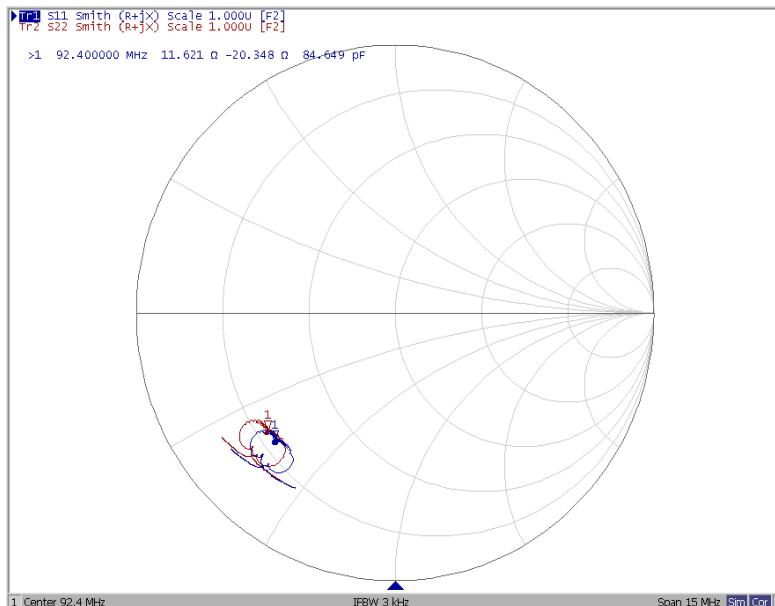



### VSWR

