

Omron Electronic Components:  
The Quality, Flexibility and Global  
Support You Need.

**For More Detailed Information...**

Visit Us Online:  
[www.components.omron.com](http://www.components.omron.com)

- Browse Omron's full range of Product Information and selection guides.
- Search the cross-reference database to locate Omron component solutions.
- Download PDF data sheets, brochures and more.
- Locate a Distributor and search for available inventory.
- Complete Terms and Conditions of Sale and Usage.

Call Us:  
1-847-882-2288 Monday through Friday,  
8:00 a.m. to 5:00 p.m. Central Time (CT)

Email Us:  
[components@omron.com](mailto:components@omron.com)

**OMRON ELECTRONIC COMPONENTS LLC**  
55 Commerce Drive, Schaumburg, IL 60173 U.S.A.

SB\_AOTBA-01  
©2012 Omron Electronic Components LLC, Printed in U.S.A.  
1/2012

[www.components.omron.com](http://www.components.omron.com)

Phone: 847-882-2288

**OMRON**  
ELECTRONIC COMPONENTS

**OMRON**  
ELECTRONIC COMPONENTS

# BUILDING Automation

Relays, Switches, Sensors  
and Connectors for the  
Building Automation Market



# Building Automation Components & Technologies

## Leading-edge Technologies for the Building Automation Market

Omron is a \$7 billion global supplier of electronic components and solutions for a broad range of applications. With over 75 years of experience manufacturing electronic components, Omron provides global and local networks of technical and sales support from design through delivery.

### Combining Core Competencies and New Technologies

Omron applies a comprehensive mix of manufacturing and technological skills to provide innovative solutions in the building automation market, starting from electromechanical components to MEMS sensors.

### Competencies

- Materials
- Precision Replication & Assembly
- Stamping & Molding
- Integration of Active Elements
- Packaging

### Technologies

- Switching
- Sensing
- Micro Lens Arrays
- Magnetic Actuators
- Nano Machining
- Micro Electro Mechanical Systems
- Solid State Devices



Omron designs and manufactures a wide range of high quality, high performance components utilizing latest technologies for Building Automation. Products include relays, switches, connectors and sensors.

Committed to quality, Omron has built its business focused on providing customers, globally, with quality products, value added services and customer care. These services are an integral part of Omron's total supply solution that includes full technical and sales support, across industries worldwide.



### Lighting

Omron's relays are ideal for switching lamp loads whether it is for 'Intelligent Lighting', which detects whether people are in an area or not, or emergency lighting, which is seldom used but still has to function reliably and efficiently when required.

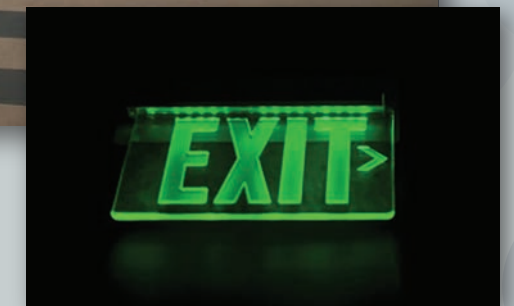

### Emergency Lighting

### Power Relays

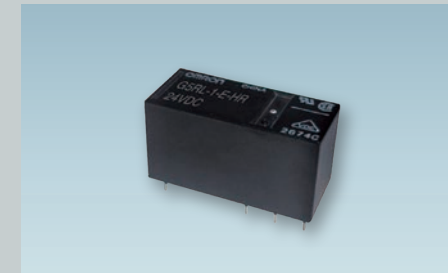

#### Power Relay G5RL-HR

Low profile relay - High Capacity model - high inrush peak currents up to 100A, approved UL TV-5



#### Power Relays G6B

Low power consumption relays - 200mW, low profile; available in latching and non-latching models.



#### Power Relays G6C

Low power consumption relays - 200mW, low profile; available in latching and non-latching models.



#### Switches D3V

Available by 0.1 A, 6 A, 11 A, 16 A and 21 A models, all with self-cleaning contacts. 0.1 A utilizes gold alloy crossbar contacts for high reliability at low loads.

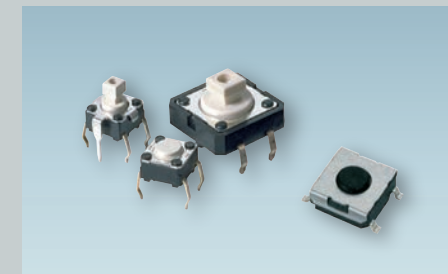

#### Tactile Switches

Available with a wide variety of actuators, mounting styles, and switching capabilities.



#### MEMS Thermal IR Module

Detection of human presence for intelligent lighting and HVAC controls utilizing arrays of 1x8 or 4x4 MEMS elements.

# Building Automation Components & Technologies



## Thermostats

Omron offers connectors and high performance relays for energy management systems, which are paramount with today's emphasis on the environment.

COMING SOON



## D6F-PH Flow Sensor

Omron's new High Impedance D6F-PH flow sensor for 0-1" H<sub>2</sub>O differential measurement is NOT AFFECTED by tube length variation. Great for VAV field installations!



Photo Courtesy of Ruskin Company

## Damper Controls

Detection Switches and Power Relays are ideal for high density applications such as louver and damper controls.

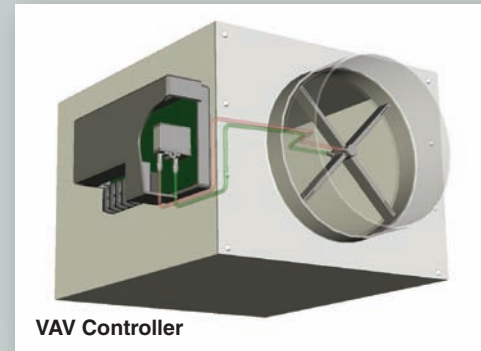

VAV Controller



## Ventilation, Air Control, and Clogged Filter Detection

Omron's flow sensors monitor air intake, fan performance and filter conditions to ensure precision performance is maintained over the system's life time. Maintaining clean filters also results in energy savings and improved indoor air quality.

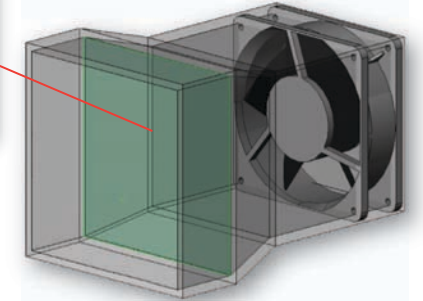

Clogged Filter Detection



## MEMS Velocity and Mass Flow Sensors

The D6F-V, D6F-W and D6F-P incorporate a DSS (Dust Segregation System) that prevents the contamination of the MEMS chip from air particles, providing a continuous, reliable and stable measurement.

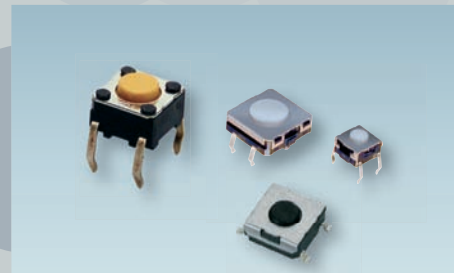

## Tactile Switches

Consistent switching characteristics offer excellent performance. Available with a wide variety of actuators, mounting styles, and switching capabilities.



## Detection Switch

Sealed and unsealed snap-action switches are available with a variety of ratings, actuators and termination options. Sealed versions are rated to IP67 and are suitable for use in "wet" environments. Unsealed are rated to a durable IP50.

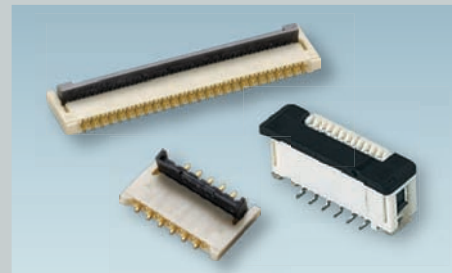

## FPC Connectors

Offers superior solutions for display interfaces. The line offers tremendously fine pitch model (0.5mm - 0.25mm). Omron's patented Rotary backlock mechanism significantly enhances work efficiency and reliability.

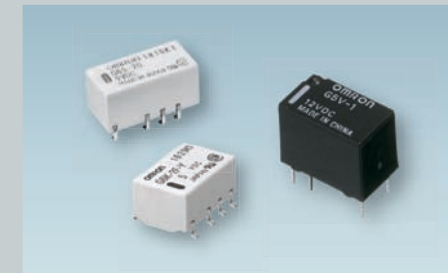

## Signal Relays G6S, G6K, G5V-1

Extremely small with very high reliability and low power consumption. Available in PCB and SMT configurations, latching and non-latching models, high surge withstand, and many, many more options.



## Power PCB Relays

Small "sugar cube" size used as common platform; sealed construction versions are available. Compact, high isolation and efficient, low coil power consumption. RoHS compliant. Coil voltages range from 3VDC (direct IC driven) to 48 VDC.

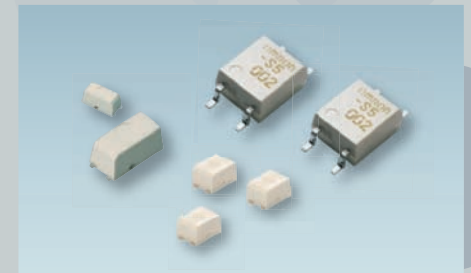

## MOS FET Relays

Omron's MOS FET relay line delivers the speed and accuracy needed for electromechanical equipment. Load current up to 2.5 Amp. Load voltage up to 600 VAC/VDC.

# Building Automation Components & Technologies



## Building Access Controls

Detection Switches, relays and connectors are used in the operation of automatic gates, automatic doors, entry phones and wall pads.



## Security and Fire/Smoke Alarm Systems

Omron components are used in a variety of applications including Passive Infrared Sensors (PIR), Thermal IR Sensors, Security Monitoring Devices, and Smoke/Fire Detectors. Omron's components can be used to set a unique address in individual smoke/heat detectors.



## Elevators and Escalators

Safety-critical applications such as elevator and escalator controls must be high quality, high performance and ultra reliable. Omron offers components that are ideally suited to this type of application and cover a number of critical functions.



Photo courtesy of Pelco

CCTV and Surveillance Control Systems need to have ultra reliable and efficient components under demanding conditions. Omron has a number of products that are extensively used within this environment, such as Connectors, MOS FET & Signal Relays and Detection Switches.

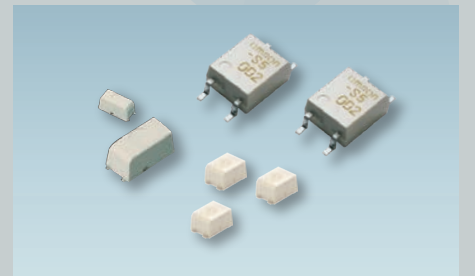

## MOS FET Relays

Omron's MOS FET relay line delivers the speed and accuracy needed for electromechanical equipment. Load current up to 2.5 Amp. Load voltage up to 600 VAC/VDC.



## PCB Relays G5Q, G5LE, and G8P

For photoelectric sensors in automatic gates and overhead doors.

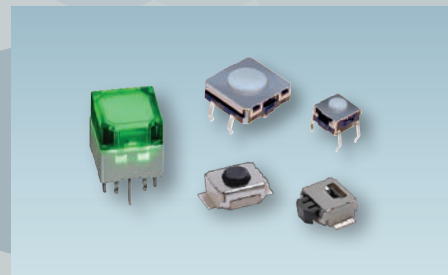

## Tactile Switches

Consistent switching characteristics offer excellent performance. Available with a wide variety of actuators, mounting styles, and switching capabilities

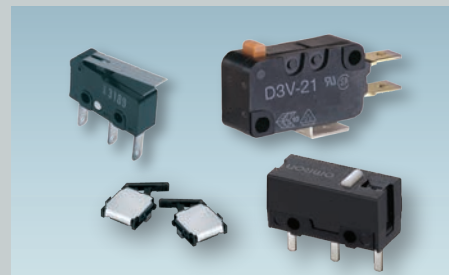

## Detection Switches

Sealed and unsealed snap-action switches are available with a variety of ratings, actuators and termination options. Sealed versions are rated to IP67 and are suitable for use in "wet" environments. Unsealed are rated to a durable IP50.

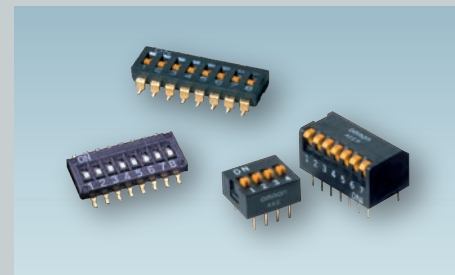

## DIP Switches

Assortment of Through-Hole, SMT DIP Switches, in standard or half pitch. Choose from flush or projected actuators; piano DIP or Top actuated models; Rotary DIP, with BCD or hexadecimal output also available.

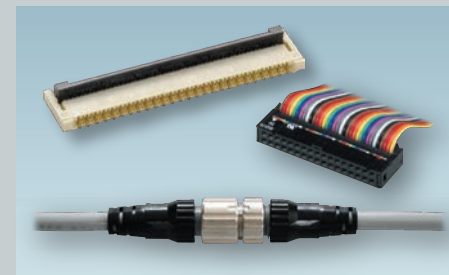

## Connectors

Omron has a wide range of connectors including FPC, PCB and Circular Waterproof Connector with Smartclick™ technology.

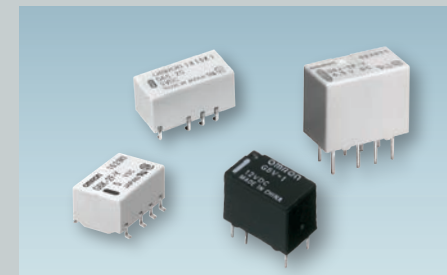

## Low Signal Relays G6S, G6K, G5V-1

Omron offers a full line of Low Signal Relays. Extremely small, very high reliability and low power consumption. Available in PCB and SMT configurations, latching and non-latching models, high surge withstand, and many, many more options.