

CONTROL PANEL WITH FONTS, GRAPHICS COMMANDS AND MACROS

Touch Panel
optional

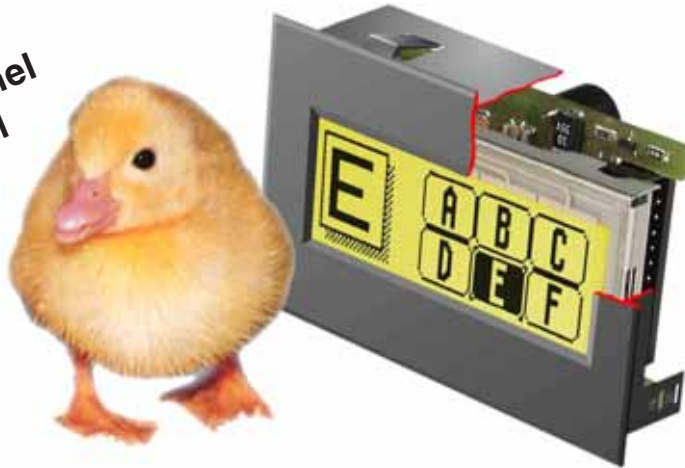

EA KIT120-5LEDTP
Dimensions 77x54mm

TECHNICAL DATA

- * LCD GRAPHICS DISPLAY WITH DIVERSE GRAPHICS FUNCTIONS AND FONTS
- * 120x32 PIXELS WITH LED BACKLIGHT GN/GB
- * FONT ZOOM FROM 3mm VIA 8mm UP TO 20mm
- * SNAP-IN HOUSING FOR EXTREMELY EASY INSTALLATION
- * LED BACKLIGHTING SWITCHABLE VIA SOFTWARE COMMAND
- * SUPPLY VOLTAGE 5V /typ. 23mA (LED ON: 180mA) OR OPTIONALLY 9..36V
- * RS-232 WITH BAUD RATES FROM 1200 TO 115200
- * POSITIONING **ACCURATE TO THE PIXEL** WITH ALL FUNCTIONS
- * PROGRAMMING BY MEANS OF HIGH-LEVEL LANGUAGE-TYPE COMMANDS:
- * STRAIGHT LINE, POINT, AREA, AND/OR EXOR, BAR GRAPH...
- * UP TO 256 BITMAP GRAPHICS/ICONS STORABLE IN THE SYSTEM
- * UP TO 256 MACROS PROGRAMMABLE (32kB INCL. FONTS AND GRAPHICS)
- * COMBINATIONS OF TEXT AND GRAPHICS
- * 5 DIGITAL INPUTS AND 5 OUTPUTS
- * OPERATING TEMPERATURE -20..+70°C, ON-BOARD TEMPERATURE COMPENSATION

ACCESSORIES

- * INTEGRATED TOUCH PANEL WITH 5x2 FIELDS (ANTI-GLARE, SCRATCH-RESISTANT)
- * FLOPPY DISK FOR MACRO PROGRAMMING (PC DOS): **EA DISK240**

ORDER DESIGNATION

120x32 DOT SWITH LED ILLUMINATION GB/GN	EA KIT120-5LED
120x32 DOT SWITH TOUCH PANEL, LED ILLUMINATION, GB/GN	EA KIT120-5LEDTP
SUPPLY VOLTAGE 9..36V INSTEAD OF 5V	EA OPT-9/36V
OPTOCOUPLER FOR THE 5 INPUTS AND OUTPUTS	EA OPT-OPTO10
CABLE (1.5m) FOR CONNECTION TO 9-PIN SUB-D AND THE IO PORTS	EA KV24-9B10

**ELECTRONIC
ASSEMBLY** GM
BH

ZEPPELINSTRASSE 19 · D-82205 GILCHING
PHONE +49-8105-778090 · FAX +49-8105-778099 · <http://www.lcd-module.de>

GENERAL

The EA KIT120 is a fully assembled control and operating unit with a variety of integrated functions. The display has very compact dimensions and offers excellent supertwist contrast, which means the unit can be put into operation immediately. It is controlled via the standard RS-232 interface. In addition to complete graphics routines for display output, the graphics unit also contains a wide variety of fonts. Graphics commands similar to high-level language are used for programming. There is no longer any need for the time-consuming programming of character sets and graphics routines. The ease of use offered by macros and input via touch panel make it a real power display. To install it, you simply insert it into the opening in the front panel.

HARDWARE

The graphics unit is designed to work with an operating voltage of +5V. A supply voltage of 9..36V is also possible. Serial asynchronous data transfer is carried out in RS-232 format. The transmission format is set permanently to 8 data bits, 1 stop bit, and no parity. Rates between 1200 baud and 115,200 baud can be set using a PC. RTS and CTS handshake lines are available.

Data format:

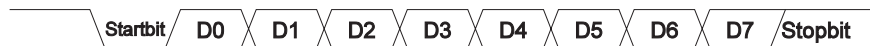

TOUCH PANEL

The EA KIT120-5LEDTP version is equipped with an integrated touch panel. You can make entries by touching the display. The labeling of the „keys“ is flexible and can also be changed during runtime (different languages, icons). The drawing of the individual „keys“ and the labeling or grouping of several fields is handled by the integrated software.

SOFTWARE

The operating unit is programmed by means of commands, such as *Draw a rectangle from (0,0) to (64, 15)*. No additional software or drivers are required. Strings can be placed with pixel accuracy. Text and graphics can be combined at any time. Up to 16 different character sets can be used. Each one can be zoomed from 2 to 4 times. When the 2-times zoom is used with the largest character set (16x8), the words and numbers displayed will fill the screen (= 16x32).

ACCESSORIES

Floppy disk for creating macros and setting the baud rate

A floppy disk (EA DISK240^{*)}) is required for macro programming. This converts the commands entered in a text file into a code that can be read by the graphics unit, and programs them into the EEPROM. If you require a different baud rate to the factory setting of 9600 baud, you need the floppy disk again.

Cable for PC

To enable simple connection to PCs (macro programming), we provide a 1.5m cable and a 9-pin SUB-D female connector. Simply insert it into COM 1 or COM 2 and get started. There is also a 10-pin socket connector for the 5 inputs and outputs (with C-MOS level) for this cable.

^{*)} also available on the Internet at <http://www.lcd-module.de/deu/disk/disk240.zip>

ELECTRONIC ASSEMBLY

EXTERNAL KEYBOARD (EA KIT120-5LED ONLY)

A keyboard (anything from individual keys to a 5x2 matrix keyboard) can be connected at the plug-in connection J4. The connected keys are debounced by means of software. Please note that it is only possible to connect an external keyboard to the EA KIT120-5LED version without an integrated touch panel and without additional options (OPT-OPTO10= or OPT-9/36V). Each key is switched between an output and an input. The inputs have a 50kΩ pullup. Up to 5 keys can be connected at each output.

Keypad Connector J4		
Pin	Symbol	Function
1	OUT 2	Output Line 2
2	OUT 1	Output Line 1
3	IN 1	Input Column 1
4	IN 2	Input Column 2
5	IN 3	Input Column 3
6	IN 4	Input Column 4
7	IN 5	Input Column 5

Transmitting the keystrokes

At each keystroke, the associated key number (1..10) is transmitted. The release of the key is not transmitted. If the release of the key is to be transmitted as well, this can be done by defining touch macro no. 0. The automatic keyboard scan can be deactivated by means of the „ESC T A 0“ command.

The key number can be determined as

follows: **(output - 1) * 5 + input** (output: the number 1 or 2, input: between 1 and 5).

Note: If the handshake line (e.g. CTS) does not permit transmission, keystrokes can be lost.

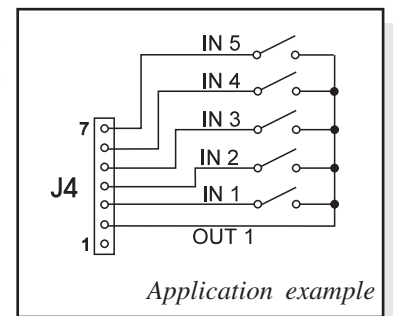
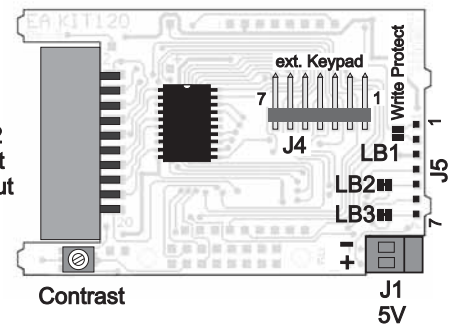

TOUCH PANEL (EA KIT120-5LEDTP ONLY)

The EA KIT120-5LEDTP version is equipped with an integrated touch panel with 10 fields. The graphics unit offers convenient commands supporting this touch panel. It is possible, for example, to group a number of touch fields to form a single large key and then draw and label the key. You can also assign a return code (1..255) to the key you have defined. If a return code of 0 is assigned, the key is disabled and has no effect when pressed.

When the touch keys are touched, they can be automatically inverted and a tone can sound, indicating they have been touched. At the same time, the internal touch macro with the number of the return code is started or, if no touch macro is defined, the return code of the key is transmitted via the serial interface.

Example:

Definition of a key from field 4 to 10 with the return code 65='A' and the text „STOP“. Note: Before individual keys are defined, all fields should be disabled by means of „ESC T R“.

Example	Codes to be output										Note		
For compiler	#TH 13, 25, 'A', 2, "STOP"										The end code 0 is not specified here		
As ASCII	ESC	T	H	.	.	A	.	S	T	O	P	.	The dots '.' stand for ASCII characters that are not to be displayed
In hex	\$1B	\$54	\$48	\$0D	\$19	\$41	\$02	\$53	\$54	\$4F	\$50	\$00	
In decimal	27	84	72	13	25	65	2	83	84	79	80	0	
Command ID	Initiation of touch command	Horizontal labeling	Upper left touch field	Lower right touch field	Return code	Drawing of key with frame						End of text ID	

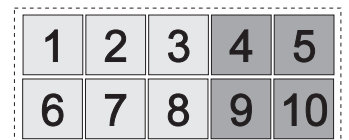

SUPPLY VOLTAGE / RS-232 CONNECTION

In the standard model, the supply voltage of +5V is fed in via screw-type terminal J1. Alternatively, the 5V supply can be connected via J3 (pin 1 and pin 10).

Note: It is imperative that the polarity is correct.

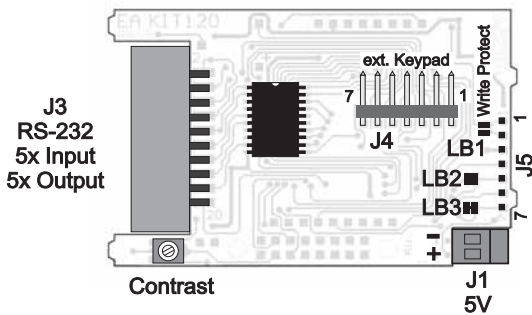

The 20-pin connector J3 contains the connection for the RS-232 interface ($\pm 12V$) and the 5 inputs and outputs (5V C-MOS level). The baud rate is set in the factory to 9600. You can use the program KITBAUD.EXE (available on EA DISK240*) to

configure it. To do this, you have to connect the KIT to COM1 or COM2 and pass the new baud rate as a parameter (e.g. KITBAUD 19200). The following baud rates can be set: 1200, 2400, 4800,

5V RS-232 Solder Pads J5			
Pin	Symbol	In/Out	Function
1	WP	In	EEPROM Write Protection
2	VDD		+5V Power Supply
3	GND		0V Ground
4	TXD5	Out	Transmit data CMOS
5	RXD5	In	Receive data CMOS
6	RTS5	Out	Request To Send CMOS
7	CTS5	In	Clear To send CMOS

9600, 19200, 38400, 56700 and 115200.

Please note that the internal data buffer is only 32 bytes. The RTS handshake line must therefore be queried (+10V level: data can be accepted; -10V level: display is busy). The data format is set permanently to 8 data bits, 1 stop bit, no parity.

If the RS-232 data is fed in to J5 at the 5V level, solder straps LB2 and LB3 must be opened.

RS-232 / PORT Box Header J3					
Pin	Symbol	In/Out	Function	EA KV24-9B10	
1	VDD	-	+ 5V PowerSupply	Pin	Pin
2	DCD	-	Bridge to DTR	1	9-pin SUB-D
3	DSR	-	Bridge to DTR	6	
4	TxD	Out	Transmit Data	2	
5	CTS	In	Clear To Send	7	
6	RxD	In	Receive Data	3	
7	RTS	Out	Request To Send	8	
8	DTR	-	see Pin 2, Pin 3	4	
9	-	-	NC	9	
10	GND	-	0V Ground	5	
11	IN1	In	CMOS Input 1	10-pin IDC socket	1
12	OUT1	Out	CMOS Output 1		2
13	IN2	In	CMOS Input 2		3
14	OUT2	Out	CMOS Output 2		4
15	IN3	In	CMOS Input 3		5
16	OUT3	Out	CMOS Output 3		6
17	IN4	In	CMOS Input 4		7
18	OUT4	Out	CMOS Output 4		8
19	IN5	In	CMOS Input 5		9
20	OUT5	Out	CMOS Output 5		10

WRITE PROTECTION FOR MACRO PROGRAMMING

Closing solder strap LB1 (WP-VDD connection) prevents the programmed macros, images and fonts from being overwritten inadvertently. The baud rate can then no longer be set either.

INPUTS AND OUTPUTS

The KIT120 is supplied with 5 digital inputs and 5 outputs (5V CMOS level, non-isolated). The connection is made at the 20-pin connector J3.

5 outputs: Each line can be controlled by means of the „ESC Y W“ command. The maximum current per line is 6mA.

5 inputs: The inputs can be queried and evaluated („ESC Y R“) directly via the serial interface. Each change of logic level (0V or 5V) at the inputs can start an internal port macro. When the 5 lines are combined, 32 port macros can be addressed. Each of these port macros can change the contents of the screen or switch an output. This allows a wide range of control tasks to be carried out. To create the port macros, you need a PC and the floppy disk EA DISK240. You will find a more detailed description of this on page 6. Automatic poll querying can be disabled by means of the „ESC Y A 0“ command.

Note: The logic circuitry is designed for slow operations; in other words, more than 3 changes per second cannot be easily executed. If an input is open, this is evaluated as high (approx. 50 kOhm pullup).

*) also available on the Internet at <http://www.lcd-module.de/deu/disk/disk240.zip>

ELECTRONIC ASSEMBLY

INPUTS AND OUTPUTS WITH OPTOCOUPLEDERS (VERSION WITH EA OPT-OPTO10)

The EA KIT120 can be supplied with optocoupler inputs and outputs (EA OPT-OPTO10). All inputs and outputs are isolated from the rest of the electronic components as well as each other. The connection is made via 10 different screw-type terminals.

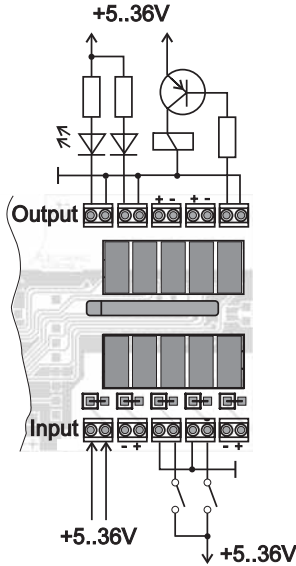

5 optocoupler outputs

The collector and emitter of a transistor are each implemented as outputs on the screw-on terminals. Each output can switch a maximum of 10mA. Note the polarity and load-dependent voltage drop of the transistor of 0.6..5V.

5 optocoupler inputs

Voltages of 4..36V can be applied directly at all 5 inputs. Voltages of over 4V are identified as high (H) level; voltages of under 2V are identified as low (L) level. Voltages between 2 and 4V are undefined. Note the polarity of the inputs (LEDs).

Note: The optocouplers invert the input logic (all inputs open: port macro N°31). It is advisable here (in the power-on macro, for example) to use the „ESC Y I 1“ command to evaluate the inputs inversely (all inputs open: port macro N°0).

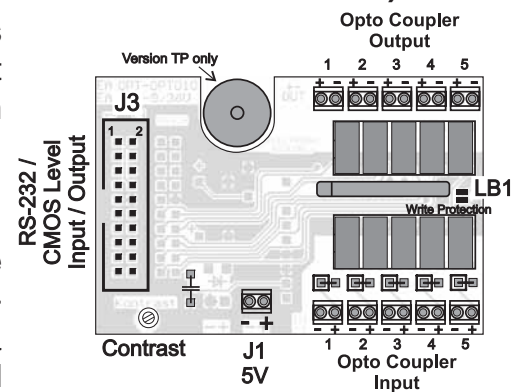

EA OPT-9/36V: SUPPLY VOLTAGE OF 9..36V

In the case of the version for 9 to 36V supply voltage (EA OPT-9/36V), the power is supplied via J2.

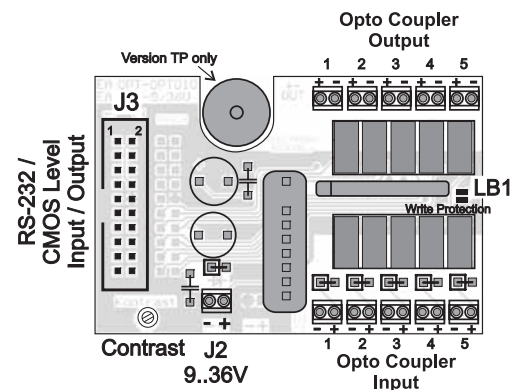
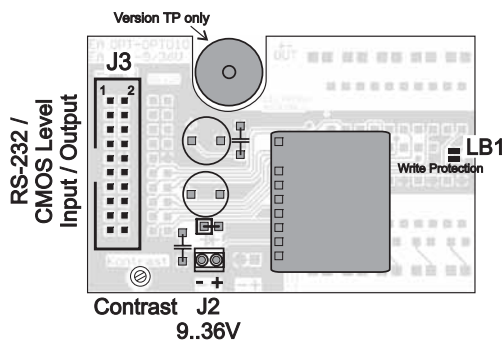

DEFAULT SETTINGS

After power-on or a manual reset, the registers shown here are set to a specific value. Please note that all the settings can be overwritten by creating a power-on macro (normal macro no. 0).



Default settings

Register	Comman	after Power On / Reset
Text mode	ESC L	Set, black
Terminal font	ESC FT	Font 3, no zoom
Cursor	ESC QC	On
Flashing time	ESC QZ	0,6 secs.
User-defined characters	ESC E	undefined
Graphics mode	ESC V	Set
Graphics font	ESC F	Font 3, no zoom
Last xy	ESC W	(0;0)
Bar graph 1..4	ESC B	undefined
Select/Deselect	ESC K	selected
LED backlight	ESC YL	On
Outputs OUT1..5	ESC Y	High level

MACRO PROGRAMMING

Single or multiple command sequences can be grouped together in macros and stored in the EEPROM. You can then start them by using the *Run macro* commands. There are 4 different types of macro:

Touch macros (1..255)(0)

These are started when you touch a touch field (in versions with a touch panel - TP) or when you operate an external key/matrix keyboard. Touch macro no. 0 is different: It is started when you release any key.

Port macros (0..31)(32..255)

These are started when there is a change in the logic level at inputs IN 1..5. The remaining port macros (32..255) are available and can be started by means of the 'ESC M P no' command.

Normal macros (1..255)

These are started by means of a command via the serial interface or from another macro. A series of macros occurring one after the other can be called cyclically (movie, hourglass, multi-page help text).

Power-on macro = normal macro (0)

Normal macro no. 0 is different: It is executed automatically after power-on. It allows you to switch off the cursor and define an opening screen, for example.

STORING 256 IMAGES IN THE EEPROM

To reduce the transmission times of the serial interface or to save storage space in the processor system, up to 256 images can be stored in the internal EEPROM. They can be called using the „ESC U E“ command via the serial interface or from within a touch/port/normal macro. All monochrome images in the Windows BMP format can be used. They can be created and edited using widely available software such as Windows Paint.

CREATING INDIVIDUAL MACROS

To create your own macros, you need the following:

- The EA DISK240*) floppy disk, which contains a compiler, examples and fonts
- A PC with a COM1 or COM2 serial interface and approximately 500KB of hard disk space
- A text editor such as WordPad or Norton Editor

To define a sequence of commands as a macro, all the commands are written to a file on the PC (e.g. DEMO.KMC). You specify which character sets are to be integrated and which command sequences are to be in which macros.

Once the macros are defined, you start the program C:>KITCOMP DEMO.KMC. This creates an EEPROM file called DEMO.EEP, which is then automatically stored in the display EEPROM with the baud rate entered. This only takes a few seconds, and you can then use your user-defined macros immediately. You will find a detailed description (in german) of how to program macros, together with a large number of examples, in the files DOKU.DOC (for WORD) and DOKU.TXT (DOS) on the EA DISK240*) floppy disk.

```
;Makro Demo
KIT120-5 ; define display type
COM2: 115200 ; KIT connected to COM2,
; Transmission at 115.200 Baud

;-----
;Define constants
AUS = 0
EIN = 1
FONT4x6 = 1
FONT5x6 = 2
FONT6x8 = 3
FONT8x8 = 4
FONT8x16 = 5
;-----
;Include fonts
Font: FONT4x6, 32, 95 INTERN4x6
Font: FONT5x6, 32, 158 INTERN5x6
Font: FONT6x8, 32, 158 INTERN6x8
Font: FONT8x8, 32, 158 INTERN8x8
Font: FONT8x16, 32, 158 INTERN8x16
;-----
Makro: 0 ; Power-on/reset macro
#QC EIN ; Cursor visible
#FT FONT8x16 ; Set terminal font
#UL 0, 20, <EA2.BMP> ; ELECTRONIC ASSEMBLY logo
```

*) also available on the Internet at <http://www.lcd-module.de/deu/disk/disk240.zip>

ELECTRONIC ASSEMBLY

INTEGRATED FONTS

Nr.	Char. height	Lines x Cols	Size in dots	ASCII area	Self def. ASCII-Codes	Note
1	3,3 mm	5 x 30	4 x 6	32 - 95	1..16	Micro
2	3,3 mm	5 x 24	5 x 6	32 - 158	1..12	Mini
3	4,5 mm	4 x 20	6 x 8	32 - 158	1..10	Standard
4	4,5 mm	4 x 15	8 x 8	32 - 158	1..8	Bold
5	7,8 mm	2 x 15	8 x 16	32 - 158	1..4	Big

5 character sets are integrated in the EA KIT120-5 as standard. Each one can be zoomed from 1 to 4 times. Independently of this, the width can also be increased two to four times.

In addition, you can define up to 16 characters of your own, depending on the font being used. These characters will remain until the supply voltage is switched off. (See the ESC E command.)

Each character can be **positioned with pixel accuracy**. Text and graphics can be combined as required. Several different font sizes can also be displayed together.

Each text can be output left justified, right justified or centered. 90° rotation (for vertical installation of the display) is also possible.

Macro programming permits the inclusion of up to 11 additional fonts and the complete redesign of the individual characters.

A font editor on the EA DISKFONT1520 floppy disk allows you to create and program in any font you like with a size of up to 16x16 pixels.

TIP: FONT EFFECTS

With large fonts, you can use the „ESCL“ command, TEXT mode (link, pattern), to produce interesting effects through overlaying (writing and offsetting a word several times).

TEST

Original font 8x16 with ZOOM 2 at position 0,0 with black pattern

TEST

„Outline font“ resulting from overlaying (EXOR) at pos. 1,1

TEST

When the „outline font“ is overlaid again (EXOR) at pos. 2,2, this results in an „outline font with filling“

TEST

Overlaying (OR) with 50% gray pattern of the „outline font“ at pos. 0,0 results in a „font with pattern filling“

+ Lower	\$0	\$1	\$2	\$3	\$4	\$5	\$6	\$7	\$8	\$9	\$A	\$B	\$C	\$D	\$E	\$F
Upper	(0)	(1)	(2)	(3)	(4)	(5)	(6)	(7)	(8)	(9)	(10)	(11)	(12)	(13)	(14)	(15)
\$20 (dez: 32)		!	"	#	\$	%	&	'	()	*	+	,	-	.	/
\$30 (dez: 48)		0	1	2	3	4	5	6	7	8	9	:	;	<	=	>
\$40 (dez: 64)		@	A	B	C	D	E	F	G	H	I	J	K	L	M	N
\$50 (dez: 80)		P	Q	R	S	T	U	V	W	X	Y	Z	[\]	^

Font 1: 4x6

+ Lower	\$0	\$1	\$2	\$3	\$4	\$5	\$6	\$7	\$8	\$9	\$A	\$B	\$C	\$D	\$E	\$F
Upper	(0)	(1)	(2)	(3)	(4)	(5)	(6)	(7)	(8)	(9)	(10)	(11)	(12)	(13)	(14)	(15)
\$20 (dez: 32)		!	"	#	\$	%	&	'	()	*	+	,	-	.	/
\$30 (dez: 48)		0	1	2	3	4	5	6	7	8	9	:	;	<	=	>
\$40 (dez: 64)		@	A	B	C	D	E	F	G	H	I	J	K	L	M	N
\$50 (dez: 80)		P	Q	R	S	T	U	V	W	X	Y	Z	[\]	^
\$60 (dez: 96)		`	a	b	c	d	e	f	g	h	i	j	k	l	m	n
\$70 (dez: 112)		o	p	q	r	s	t	u	v	w	x	y	z	{		}
\$80 (dez: 128)		~	!	@	A	B	C	D	E	F	G	H	I	J	K	L
\$90 (dez: 144)		M	N	O	P	Q	R	S	T	U	V	W	X	Y	Z	[

Font 3: 6x8

+ Lower	\$0	\$1	\$2	\$3	\$4	\$5	\$6	\$7	\$8	\$9	\$A	\$B	\$C	\$D	\$E	\$F
Upper	(0)	(1)	(2)	(3)	(4)	(5)	(6)	(7)	(8)	(9)	(10)	(11)	(12)	(13)	(14)	(15)
\$20 (dez: 32)		!	"	#	\$	%	&	'	()	*	+	,	-	.	/
\$30 (dez: 48)		0	1	2	3	4	5	6	7	8	9	:	;	<	=	>
\$40 (dez: 64)		@	A	B	C	D	E	F	G	H	I	J	K	L	M	N
\$50 (dez: 80)		P	Q	R	S	T	U	V	W	X	Y	Z	[\]	^
\$60 (dez: 96)		`	a	b	c	d	e	f	g	h	i	j	k	l	m	n
\$70 (dez: 112)		o	p	q	r	s	t	u	v	w	x	y	z	{		}
\$80 (dez: 128)		~	!	@	A	B	C	D	E	F	G	H	I	J	K	L
\$90 (dez: 144)		M	N	O	P	Q	R	S	T	U	V	W	X	Y	Z	[

Font 5: 8x16

ALL THE COMMANDS AT A GLANCE

When you switch the unit on, the cursor flashes in the first line, indicating that the display is ready for operation. All the incoming characters are displayed in ASCII format (exception: CR, LF, FF, ESC). Line breaks are automatic or can be executed by means of the 'LF' character. When the display is full, the cursor returns to position 1,1. The 'FF' character (page feed) deletes the display.

All additional commands (for positioning the cursor or setting a font, or graphics commands, for example) are introduced by the ESCAPE character (dec 27/ hex 1B).

Command table for the EA KIT120-5										
Command	Codes					Note				
Commands for terminal operation										
Form feed FF (dec:12)	^L					Deletes the screen and sets the cursor at position (1,1)				
Carriage return CR(13)	^M					Positions the cursor on the left at the beginning of the line				
Line feed LF (dec:10)	^J					Positions the cursor in the line below the current one. If the cursor is in the last line, positions it in the 1st line				
Cursor on/off	ESC	Q	C	n1		n1=0: cursor is not visible; n1=1: cursor flashes (inverse 6/10s)				
Position cursor	ESC	O	n1	n2		n1=column; n2=line; upper left origin is (1,1)				
Set terminal font	ESC	F	T	n1		n1=1: sets font no. n1 (1..16) for terminal operation				
Text output commands										
Text mode	ESC	L	n1	pat		Mode n1: 1=set; 2=delete; 3=inverse 4=replace; 5=inverse replace; pat: pattern no. 0..7				
Set font	ESC	F	n1	n2	n3		Sets font with the number n1 (1..16); n2=X- n3=Y-zoom factor (1x..4x)			
Output string horizontally	ESC	Z	L Z R	x1	y1	Text ...	NUL			Outputs a string (...) at x1,y1. 'NUL' (\$00)=end of string; lines are separated by the character ' ' (\$7C, dec: 124); 'L':= left justified at x1; 'Z':= centered at x1; 'R':= right justified at x1; y1 is always the upper edge of the string
Output string rotated by 90° (vertically)	ESC	Z	O M U	x1	y1	Text ...	NUL			Outputs a string (...) rotated by 90° at x1,y1; 'NUL' (\$00)=end; lines are separated by the character ' ' (\$7C, dec: 124); 'O':= top justified at y1; 'M':= vertically centered at y1; 'U':= bottom justified at y1; x1 is always the right edge of the string
Define character	ESC	E	n1	data ...						n1=character no.; data=number of bytes depending on current font
Drawing commands										
Graphics mode	ESC	V	n1							Sets the drawing mode for the commands 'Set point', 'Draw straight line', 'Rectangle', 'Rounded rectangle' and 'Fill area with pattern' n1: 1=set; 2=delete; 3=inverse; 4=replace; 5=inverse replace
Set point	ESC	P	x1	y1						Sets a pixel at position x1, y1
Draw straight line	ESC	G	x1	y1	x2	y2				Draws a straight line from x1,y1 to x2,y2
Continue straight line	ESC	W	x1	y1						Draws a straight line from the last end point to x1, y1
Rectangle commands										
Draw rectangle	ESC	R	R	x1	y1	x2	y2			Draws a rectangle (frame) from x1,y1 to x2,y2
Draw rounded rectangle			N	x1	y1	x2	y2			Draws a rectangle with rounded corners from x1,y1 to x2,y2
Delete area			L	x1	y1	x2	y2			Deletes an area from x1,y1 to x2,y2 (all pixels off)
Invert area			I	x1	y1	x2	y2			Inverts an area from x1,y1 to x2,y2 (inverts all pixels)
Fill area			S	x1	y1	x2	y2			Fills an area from x1,y1 to x2,y2 (all pixels on)
Fill area with pattern			M	x1	y1	x2	y2	pat		Fills an area from x1,y1 to x2,y2 with the pattern pat (0..7)
Draw box			O	x1	y1	x2	y2	pat		Draws a rectangle with the fill pattern pat (0..7); (always replace)
Draw rounded box			J	x1	y1	x2	y2	pat		Draws a rectangle with the fill pattern mst (0..7); (always replace)
Bitmap image commands										
Image from EEPROM	ESC	U	E	x1	y1	no				Loads an internal image with the number (0..255) from the EEPROM to x1,y1
Load image			L	x1	y1	data ...				Loads an image to x1,y1; see image structure for the data of the image
Send hard copy		H	x1	y1	x2	y2				Requests an image. Sends the width and height in pixels followed by the actual image data via RS232

Bar graph commands														
Define bar graph	ESC	B	R L O U	no	x1	y1	x2	y2	sv	ev	pat	Defines a bar graph to the left (L), right (R), top (O) or bottom (U) with the number no (1..4). x1,y1,x2,y2 define the rectangle enclosing the bar graph. sv,ev are the values for 0% and 100%. pat=pattern (0..7)		
Draw bar graph			no	value							Sets the bar graph with the number no (1..4) to the new user 'value'			
Keyboard/touch panel commands														
Define touch key with horizontal label	ESC	T	H	f1	f2	Ret code	frm	Text ...	NUL			Groups touch fields f1 to f2 (diametrically opposite corner fields) together to form a touch key with the return value 'Ret. code' (=1..255) (Ret. code=0 means the touch key is inactive). 'frm': Draws touch key (=0 nothing; =1 delete; =2 with frame) 'Text': Positions a string on the touch key (centered) using the current font; lines are separated by the character ' ' (\$7C, dec: 124); NUL character (\$00) = end of string		
Define touch key with vertical label (rotated by 90°)			V											
(P)reset touch keys			P	Activates all touch keys in ascending order (fields with code 1..10)										
			R	Deactivates all touch keys (all fields with code 0)										
Touch key response			I	n1	n1=0: Touch key is not inverted when touched n1=1: Touch key is automatically inverted when touched									
			S	n1	n1=0: No tone sounds when (touch) key is touched n1=1: Tone sounds briefly when (touch) key is touched									
Invert touch key			M	n1	The touch key assigned the return code n1 is inverted manually									
Query key manually			W	Sends the currently depressed (touch) key at the RS-232 interface										
Key query on/off			A	n1	The keyboard query is n1=0:deactivated; n1=1:activated, keystrokes are sent automatically; n1=2:activated, keystrokes are not sent (query with ESC T W)									
Control/definition commands														
Automatic flashing area (cursor function)	ESC	Q	D	x1	y1	x2	y2					Defines a flashing area from x1,y1 to x2,y2; activates the flashing function		
			Z	n1	Sets the flashing time n1= 1..15 in 1/10s; 0=deactivates the flashing function									
			C	n1	Automatically flashing area as cursor for terminal operation n1=0: deactivates flashing function; n1=1: activates flashing function (inverse, 6/10s)									
Select/deselect	ESC	K	S	add							Activates the kit with the address n1 (n1=255: all)			
			D	add							Deactivates the kit with the address n1 (n1=255: all)			
			A	add							Assigns a new address (add) (in the power-on macro, for example)			
Wait (pause)	ESC	X	n1								Wait n1 tenths of a second before the next command is executed			
Buzzer on/off	ESC	J	n1								n1=0:tone off; n1=1:tone on; n1=2..255:for n1 tenths sec. long on			
Send bytes	ESC	S	num	data ...							Sends num (1..255; 0=256) bytes at the RS-232 interface; data ... = num bytes (e.g. control of an external serial printer)			
Port commands														
Write output port	ESC	Y	W	n1	n2						n1=0: Sets all 5 output ports in accordance with n2 (=8-bit binary value) n1=1..5: Resets (n2=0), sets (n2=1) or inverts (n2=2) output port n1			
Read input port			R	n1								n1=0: Reads in all 5 input ports as 8-bit binary value n1=1..5: Reads in input port <n1> (1=high level=5V, 0=low level=0V)		
Port scan on/off			A	n1									Deactivates (n1=0) or activates (n1=1) automatic scanning of the input port	
Input port inverse			I	n1									Evaluates the input port (n1=0: normal; n1=1: inverted)	
LED backlight on/off			L	n1									Switches LED backlight n1=0: off; n1=1: on; n1=2: toggle; n1=2..255: for n1 tenths sec. long on and then off	
Display commands (which apply to the whole display)														
Delete display	ESC	D	L								Deletes the contents of the display (all pixels off)			
Invert display			I									Inverts the contents of the display (inverts all pixels)		
Fill display			S									Fills the contents of the display (all pixels on)		
Switch display off			A									Makes the contents of the display invisible, but they remain there and further commands are possible		
Switch display on			E									Makes the contents of the display visible again		
Reset display			R									Resets and re-initializes the display controller		
Macro commands														
Execute macro	ESC	M	N	n1							Calls the (normal) macro with the number n1 (max. 7 levels)			
Execute touch macro			T	n1								Calls the touch macro with the number n1 (max. 7 levels)		
Execute port macro			P	n1									Calls the port macro with the number n1 (max. 7 levels)	
Macros autom. cyclical			A	n1	n2	n3						Processes macros n1..n2 automatically cyclically; n3=pause in 1/10s		
Macros autom. ping-pong			J	n1	n2	n3						Processes macros n1..n2..n1 automatically (ping-pong); n3=pause in 1/10s		

PARAMETERS

The graphics unit can be programmed by means of various integrated commands. Each command begins with ESC followed by one or two command letters and then parameters. All the commands and their parameters, such as coordinates and other transfer values, are always expected as bytes. No separating characters, such as spaces or commas, must be used between them. The commands require no final byte, such as a carriage return (apart from the string \$00).

A..Z, L/R/O/U All commands are transferred as ASCII characters.
Example: « G= 71 (dec.) = \$47 initiates the straight line command.

x1, x2, y1, y2 Coordinate specifications are transferred with 1 byte.
Example: x1= 10 (dec.) = \$0A

ESC 1 byte: 27(dec.) = \$1B

n1,n2,no,sv,ev,value,pat,data frm,data Numerical values are transferred with 1 byte.
Example: n1=15(dec.) = \$0F

PROGRAMMING EXAMPLE

The following table shows an example in which the character chain „Test“ is output at coordinate 7,3.

Example	Codes to be output									
	ESC	Z	L	BEL	ETX	T	e	s	t	NUL
In ASCII	ESC	Z	L	BEL	ETX	T	e	s	t	NUL
In hex	\$1B	\$5A	\$4C	\$07	\$03	\$54	\$65	\$73	\$74	\$00
In decimal	27	90	76	7	3	84	101	115	116	0
For Turbo Pascal	write(aux, chr(27), 'Z', 'L', chr(7), chr(3), 'Test', chr(0));									
For C	fprintf(stdaux, "\x1BZL%c%c%s\x00", 7, 3, "Test");									
For Q Basic	OPEN "COM1:9600,N,8,1,BIN" FOR RANDOM AS #1 PRINT #1,CHR\$(27)+"ZL"+CHR\$(7)+CHR\$(3)+"Test"+CHR\$(0)									

PATTERN

A pattern type (pat = 0..7) can be set as a parameter with some commands. In this way, rectangular areas, bar graphs and even text can be linked to different patterns and displayed.

The following fill patterns are available:

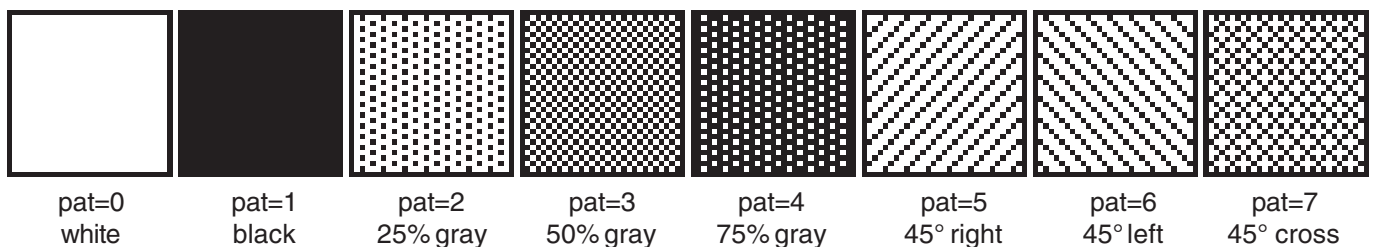

ELECTRONIC ASSEMBLY

DESCRIPTIONS OF THE VARIOUS GRAPHICS FUNCTIONS

On the following pages you will find detailed descriptions of all the functions in alphabetical order. In each case, an enlarged section of the image, 50x32 pixels in size, is shown as a hard copy example, indicating the contents of the display after the command has been executed. The bytes to be transferred are shown as hex values in the examples.

ESC B L/R/O/U no x1 y1 x2 y2 sv ev pat**Define bar graph**

Up to 4 bar graphs (**no**=1..4) can be defined. These can extend to the left (**L**), right (**R**), up (**O**) or down (**U**). At its full extent, the bar graph occupies an area from coordinate **x1,y1** to **x2,y2**. It is scaled with the start value (no extension), **sv** (=0..254), and the end value (full extension), **ev** (=0..254). The bar graph is always drawn in inverse mode with the pattern (**pat**): The background is thus always retained. (Note: When this command is executed, it defines the bar graph but does not display it.)

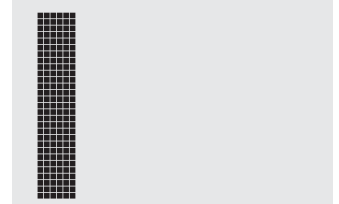
Example:

\$1B \$42 \$4F \$01 \$04 \$02 \$09 \$1E \$04 \$14 \$01

Bar graph no. 1, which extends upwards, is defined. When it is fully extended, it takes up an area from 4,2 to 9,30. The start and end values correspond to a 4..20 mA display. (The diagram shows the bar graph fully extended, as represented with \$42 \$01 \$14.)

ESC B no value**Draw bar graph**

The bar graph with the number **n1** (1..4) is set to the new value (sv <= **value** <= ev). If **value** > ev, the end value (ev) is displayed. The bar graph must be defined first (see above).

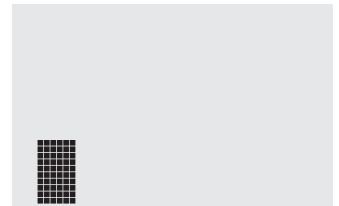
Example:

\$1B \$42 \$01 \$0A

Bar graph no. 1 defined in the above example is set to a value of 10.

ESC D L**Delete contents of display**

The entire contents of the display are deleted (white).

Example: \$1B \$44 \$4C

ESC D I**Invert contents of display**

The entire contents of the display are inverted.

Example: \$1B \$44 \$49

ESC D S**Fill contents of display**

The entire contents of the display are filled (black).

Example: \$1B \$44 \$53

ESC D A**Switch display off**

The contents of the display are switched off (made invisible). Outputs are also possible when the contents of the display are switched off.

Example: \$1B \$44 \$41

After this command is executed, the contents of the display are no longer visible.

ESC D E**Switching the display on**

The contents of the display are switched on (made visible).

Example: \$1B \$44 \$41

After this command is executed, the contents of the display become visible again.

ESC E n1 data

Define character

You can define up to 16 characters yourself (depending on the size of the font). These characters then have the ASCII codes 1 to max. 16 and remain in an invisible screen RAM 64 bytes in size until the supply voltage is switched off. In the case of a 4x6 font, up to 16 characters can be defined, whereas only 4 characters can be defined for an 8x16 font. Note: Please note that if you want to define several characters in different fonts, you must bear in mind that a character with code 1 of the 8x16 font, for example, requires the same amount of RAM as characters with the codes 1 to 4 of the 4x6 font (see the adjacent table).

Example 1:

\$1B \$45 \$01

\$04 \$02 \$7F \$02 \$04 \$00

Defines an arrow pointing upward for ASCII no. 1 using the 6x8 character set.

Example 2:

\$1B \$45 \$02

\$00 \$00 \$00 \$FF \$00 \$00 \$00 \$00

\$04 \$08 \$10 \$3F \$10 \$08 \$04 \$00

Defines an arrow pointing downward for ASCII no. 2 using the 8x16 character set.

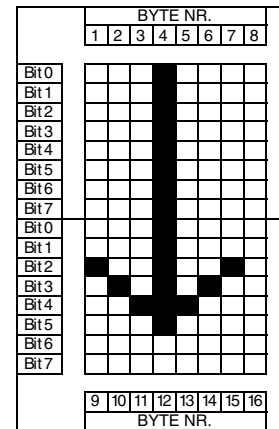
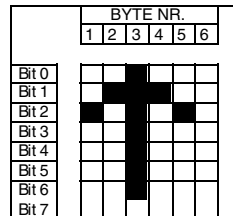

User defined characters (code)	
4x6	8x16
1	1
2	2
3	3
4	4
5	5
6	6
7	7
8	8
9	9
10	10
11	11
12	12
13	13
14	14
15	15
16	16

ESC F n1 n2 n3

Sets the font with the number **n1**. In addition, an enlargement factor (1..4 times) is set for the width (**n2**) and the height (**n3**) separately.

Example: \$1B \$46 \$02 \$03 \$04

The 6x8 font with 3 times the width and 4 times the height is set with immediate effect.

In the adjacent figure, the character 'E' is shown in the 6x8 font with various enlargements.

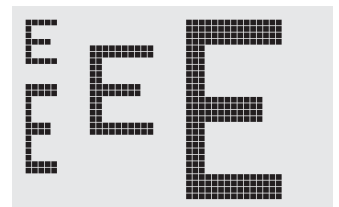

Set font

ESC F T n1

Set terminal font

Sets the font with the number **n1** for the terminal. The font for the terminal is always used without zoom and in REPLACE mode.

Example: \$1B \$46 \$54 \$03

The 6x8 font is set as the terminal font with immediate effect.

ESC G x1 y1 x2 y2

Draw straight line

A straight line is drawn from **x1,y1** to **x2,y2**, taking into account the set graphics mode 'V' (set/delete/inverse).

Example: \$1B \$47 \$03 \$14 \$28 \$06

A straight line is drawn from 3,20 to 50,6.

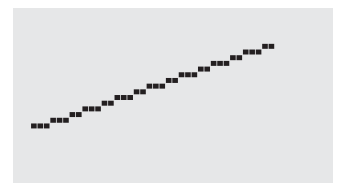

ESC H x1 y1 x2 y2

Create hard copy of display contents

Requests the area from the upper left corner (**x1,y1**) to the lower right corner (**x2,y2**). The kit then immediately sends the width and height of the image section followed by the image data. See the upload image command (**ESC U L**) for the structure of the image data.

Example: \$1B \$48 \$00 \$00 \$1F \$0F

The upper left part of the screen (32 x 16 pixels) is sent via RS-232.

ESC J n1

Switch tone on/off manually

Switches the tone off (**n1=0**), on for an undefined period (**n1=1**) or on for n1/10 seconds (**n1=2..255**). (This only applies to versions with the EA KIT120-5LEDTP touch panel.)

Example: \$1B \$4A \$0A

The tone sounds for 1 second after this command.

ELECTRONIC ASSEMBLY

ESC K A add

Assign address

Assigns an address to the KIT (**adr**=0..254). The best place for this command is in the power-on macro.

Example: \$1B \$4B \$41 \$01

The KIT is assigned the address \$01 with immediate effect.

ESC K S/Dadd

(De)select EA KIT120

Selects (**S**) or deselects (**D**) the KIT with the address **add** (0..254); the address 255=\$FF is a master address for all KITs.

Example: \$1B \$4B \$44 \$01

All commands for the KIT with the address \$01 are ignored with immediate effect.

ESC L n1 pat

Sets the link mode (**n1**) and pattern (**pat**) for the string output text function (**ESC Z**).

Example:

\$1B \$4C \$03 \$03

Sets the link mode for all subsequent text functions to gray characters (pattern 3 = 50% gray) inverted with the background.

Link mode n1:

- 1 = set: black pixels irrespective of the previous value (OR)
- 2 = delete: white pixels irrespective of the previous value
- 3 = inverse: changes black pixels to white pixels and vice versa (EXOR)
- 4 = replace: deletes the background and set black pixels
- 5 = inverse replace: fills the background and sets white pixels

Set text mode

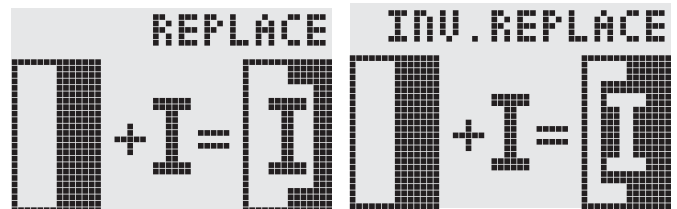
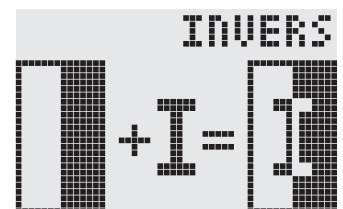
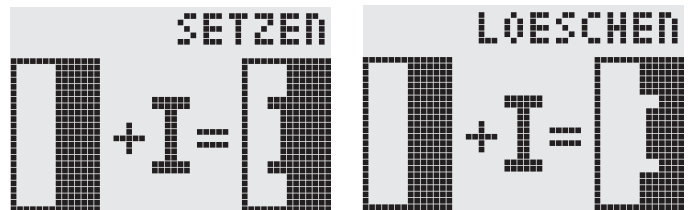

ESC M N n1

Call macro

Calls the (normal) macro with the number **n1** (0..255).

Example: \$1B \$4D \$4E \$0F ; macro number 15 is started after this command.

ESC M T n1

Call touch macro

Calls the touch macro with the number **n1** (0..255).

Example: \$1B \$4D \$4E \$0F ; touch macro number 15 is started after this command.

ESC M P n1

Call port macro

Calls the port macro with the number **n1** (0..255).

Example: \$1B \$4D \$4E \$0F ; port macro number 15 is started after this command.

ESC M A/J n1 n2 n3

Execute macros automatically

Calls the normal macros with the numbers **n1** to **n2** automatically every **n3**/10 seconds. **A**=cyclical call (e.g. 1,2,3,4,1,2,3,4 etc.); **J**=ping-pong call (e.g. 1,2,3,4,3,2,1,2,3,4 etc.).

Automatic execution is terminated:

- When a character is received from the RS-232 interface
- When a touch automatically executes a touch macro
- When an input change executes a port macro

Example: \$1B \$4D \$41 \$01 \$03 \$05

The macros with the numbers 1, 2 and 3 are executed automatically with a break of 1/2 second.

ESC O n1 n2

Position cursor

Sets the cursor to column **n1** and row **n2** for terminal operation. The origin in the upper left corner is 1,1.

Example:

```
$1B $4F $03 $05
```

Sets the cursor to the 3rd column in row 5.

ESC P x1 y1

Sets a pixel at **x1,y1**, taking into account the set graphics mode 'ESC V' (set/delete/invert).

Example:

```
$50 $11 $0D
```

Sets the pixel at 17,13.

Set point

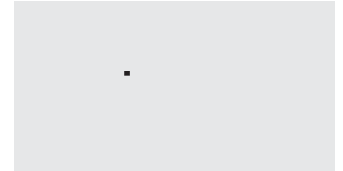

ESC Q C n1

Cursor on/off

n1=1: Switches the cursor on; it flashes at the current position on the terminal.

n1=0: Switches the cursor off.

Example:

```
$1B $51 $43 $01
```

Switches the cursor on.

ESC Q D x1 y1 x2 y2

Define flashing area

Defines the area from the upper left corner (**x1,y1**) to the lower right corner (**x2,y2**) as an automatically inverting area and starts the flashing function. This deactivates the terminal cursor.

Example:

```
$1B $51 $44 $00 $0F $07 $10
```

Defines the flashing area from 0,15 to 7,16.

ESC Q Z n1

Set flashing time

Sets the flashing time to **n1** (=1..15) tenths of a second. When **n1=0**, the flashing function is deactivated and the original screen restored.

Example:

```
$1B $51 $5A $03
```

Sets the flashing time to 0.3 seconds.

ESC R R x1 y1 x2 y2

Draw rectangle

Draws a rectangle from the upper left corner (**x1,y1**) to the lower right corner (**x2,y2**) taking into account the set graphics mode 'V' (set/delete/inverse). The contents of the rectangle are not changed. See 'ESC R O' (Draw box).

Example:

```
$1B $52 $52 $15 $08 $30 $25
```

Draws a rectangle from 21,8 to 48,37.

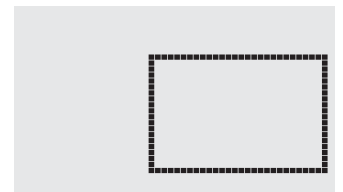

ESC R N x1 y1 x2 y2

Draw rounded rectangle

Draws a rectangle with rounded corners from the upper left corner (**x1,y1**) to the lower right corner (**x2,y2**) taking into account the set graphics mode 'V' (set/delete/inverse). The contents of the rounded rectangle are not changed. See 'ESC R J' (Draw rounded box).

Example:

```
$1B $52 $4E $06 $02 $26 $13
```

Draws a rounded rectangle from 6,2 to 38,19.

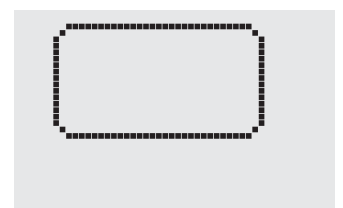

ELECTRONIC ASSEMBLY

ESC R L x1 y1 x2 y2

Deletes the area from the upper left corner (**x1,y1**) to the lower right corner (**x2,y2**).

Example:

\$1B \$44 \$53 \$1B \$52 \$4C \$06 \$04 \$28 \$19

The display is filled with **ESC D S** and then deleted from 6,4 to 40,25.

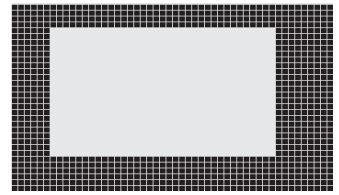
Delete area**ESC R I x1 y1 x2 y2**

Inverts the area from the upper left corner (**x1,y1**) to the lower right corner (**x2,y2**) (black pixels turn white and vice versa).

Example:

\$1B \$52 \$49 \$00 \$00 \$17 \$1B

Inverts the area from 0,0 to 23,27 with the display contents from the "Set font" example.

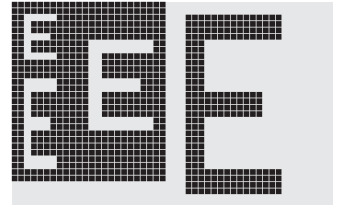
Invert area**ESC R S x1 y1 x2 y2**

Fills the area from upper left corner (**x1,y1**) to the lower right corner (**x2,y2**) (sets the pixels to black).

Example:

\$1B \$52 \$53 \$09 \$05 \$16 \$16

Sets the area from 9,5 to 22,22 to black.

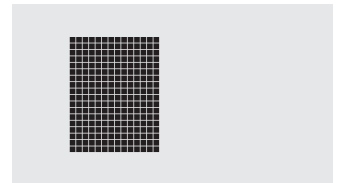
Fill area**ESC R M x1 y1 x2 y2 pat**

Fills a rectangular area from the upper left corner (**x1,y1**) to the lower right corner (**x2,y2**) with the pattern **pat** taking into account the set graphics mode 'ESC V' (set/delete/invert/replace/inverse replace).

Example:

\$1B \$52 \$4D \$05 \$01 \$2D \$1A \$07

Fills the area with the pattern 7=45°cross from 5,1 to 45,26.

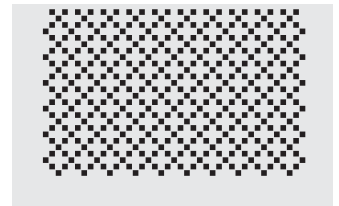
Fill area with pattern**ESC R O x1 y1 x2 y2 pat**

Draws a rectangle with rounded corners from the upper left corner (**x1,y1**) to the lower right corner (**x2,y2**) with the pattern **pat**. The background of the box is deleted. See 'ESC R R' (Draw rectangle).

Example:

\$1B \$52 \$4F \$02 \$05 \$12 \$1E \$02

Draws a box from 2,5 to 18,30 with the pattern 2=25% gray.

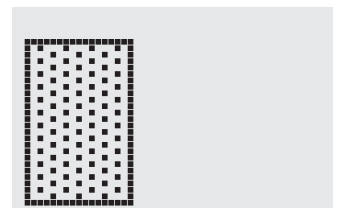
Draw box**ESC R J x1 y1 x2 y2 pat**

Draws a rectangle with rounded corners from the upper left corner (**x1,y1**) to the lower right corner (**x2,y2**) with the pattern **pat**. The background is deleted. See 'ESC R N' (Draw rounded rectangle).

Example:

\$1B \$52 \$4A \$07 \$03 \$23 \$16 \$03

Draws a rounded box from 7,3 to 35,22 with the pattern 3=50% gray.

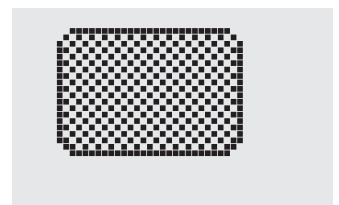
Draw rounded box**ESC S num data...**

Outputs the next **num** (1..255, 0=256) bytes at the serial interface.

Example:

\$1B \$53 \$04 \$54 \$45 \$53 \$54

Sends the word 'TEST' via the RS-232C interface.

Send bytes via RS-232

ESC T H/V f1 f2 ret frm text... NUL

Define touch key

Defines a touch key and labels it with the current font. **H**=horizontal or **V**=vertical labeling (rotated 90°). Several touch fields can be grouped together to form a single touch key (**f1**=upper left touch field; **f2**=lower right touch field of the new touch key). This touch key is assigned a return code with **ret** (1..255). When the touch key is touched, the touch macro with the number **ret** is called or, if no touch macro is defined, this return code is sent via the RS232. You use **frm** to define the format of the touch key (frm=0: don't draw anything; frm=1: delete touch key; frm=2: delete touch key and draw with frame). **text...**=string with the label (which is always centered on the touch key). The label can also have more than one line; in this case, the lines are separated by the character '|' (=\$7C). The string must be concluded with **NUL**= \$00. See the example on page 3.



Example 1: Horizontal touch key:

\$1B \$54 \$48 \$01 \$01 \$41 \$02 \$54 \$45 \$53 \$54 \$00

Defines a horizontal touch key (field no. 1 only) with the return code 65='A'. The touch key is drawn with a frame and labeled with the word 'TEST'.

Example 2: Vertical touch key:

\$1B \$54 \$56 \$02 \$02 \$42 \$02 \$54 \$45 \$53 \$54 \$00

Defines a vertical touch key (touch field no. 2 only) with the return code 66='B'. The touch key is drawn with a frame and labeled with the word 'TEST'.



ESC T P/R

Preset/reset touch fields

Assigns **P** (=ascending return code: 1..10) or **R** (=reset all touch fields) to all 10 touch fields. In the latter case, all touch fields receive the return code 0 (i.e. they are deactivated).

Example: \$1B \$54 \$52

All touch fields are deactivated by this command and no longer recognized.

ESC T I/S n1

Touch key response

These commands set the automatic response of the touch panel to touching. Both responses can be activated simultaneously.

I=automatic inversion when the touch key is touched (**n1**=0: off or **n1**=1: on)

S=automatic signal tone when the touch key is touched (**n1**=0: off or **n1**=1: on)

Example: \$1B \$54 \$49 \$01

After this command the tone sounds when a touch key is touched.

ESC T M ret

Invert touch key manually

This command manually inverts the touch key with the return code **ret**.

Example: \$1B \$54 \$4D \$41

Inverts the touch key from the above example with the return code 65='A'.

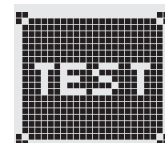

ESC T A n1

(Touch) key query on/off

This command sets the (touch) key query:

n1=0: Switches the query key off - no touch macros or manual key query possible.

n1=1: Activates the key query - keystrokes trigger touch macros or are sent via RS232.

n1=2: Activates the key query - keystrokes trigger touch macros; must be queried manually.

Example: \$1B \$54 \$41 \$02

Activates the (touch) key query. The keystrokes are not sent automatically via RS232; they have to be requested manually by means of the **ESC T W** command.

ESC T W

Query touch key manually

Sends the return code of the currently pressed touch key at the RS232.

Example: \$1B \$54 \$57

ELECTRONIC ASSEMBLY

ESC U E x1 y1 n1

Load image from EEPROM

Displays the image saved in the EEPROM with the number **n1** (0..255) at position **x1,y1**.

Example:

```
$1B $55 $45 $02 $03 $0E
```

Displays image number 14 from the EEPROM at position 2,3.

ESC U L x1 y1 data...

Displays an image at position **x1,y1**.

data..:

- 1 byte for the image width in pixels
- 1 byte for the image height in pixels
- Image data: number = $((\text{height}+7) / 8) * \text{width bytes}$

1 byte stands for 8 horizontal pixels on the screen; 0=white, 1=black;

LSB: top, MSB: bottom; the image is stored from left to right.

The BMP2BLV.EXE program on the EA DISK240 floppy disk available as an accessory creates the image data, including the width and height, from monochrome Windows bitmap graphics (*.BMP).

Example:

```
$1B $55 $4C $09 $04 $0C $0C
$F0 $FC $FE $FE $F7 $BF $BF $F7 $FE $FE $FC $F0
$00 $03 $07 $06 $0D $0D $0D $0D $06 $07 $03 $00
```

Loads the adjacent image at position 9,4.

Upload image

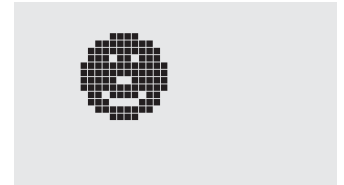

	BYTE NR																							
	1	2	3	4	5	6	7	8	9	10	11	12	13	14	15	16	17	18	19	20	21	22	23	24
Bit 0																								
Bit 1																								
Bit 2																								
Bit 3																								
Bit 4																								
Bit 5																								
Bit 6																								
Bit 7																								

ESC V n1

Set graphics mode

Sets the link mode **n1** for the following graphics functions: ESC P (Set point), ESC G (Draw straight line), ESC W (Continue straight line), ESC R R (Draw rectangle), ESC R N (Draw rounded rectangle), ESC R M (Fill area with pattern).

Example:

```
$1B $56 $03
```

Sets the link mode to inverse.

By way of example, a rectangle is drawn alongside with the link modes set, delete and inverse on an existing background.

Link mode n1:

- 1=set: black pixels irrespective of the previous value (OR)
- 2=delete: white pixels irrespective of the previous value
- 3=inverse: changes black pixels to white pixels and vice versa (EXOR)
- 4=replace: deletes the background and sets black pixels; only area with fill pattern 'pat'
- 5=inverse replace: fills the background and sets white pixels; only area with fill pattern 'pat'.

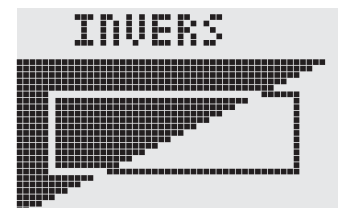
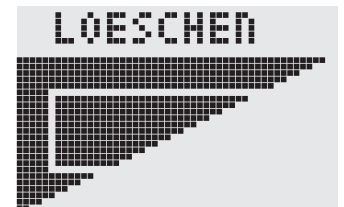
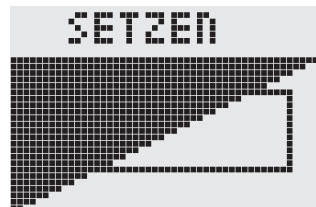

ESC W x1 y1

Continue straight line

Continues a straight line from the last end or point drawn to **x1,y1** taking into account the set graphics mode 'V'.

Example:

```
$1B $47 $00 $00 $10 $04
$1B $57 $16 $1B
$1B $57 $30 $0F
```

A straight line is drawn from 0,0 to 16,4. It is then continued to 22,27 and to 48,15.

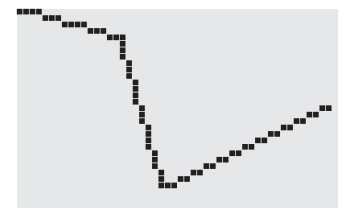

ESC X n1

Wait/pause

This command suspends the KIT for **n1**/10 seconds.

Example:

```
$1B $58 $0A
```

After this command the KIT waits for a second before the next command is processed.

ESC Y R n1

Read input port

Reads in the input port (**n1**=1..5 = IN1..IN5). When **n1**=0, all the inputs are read in as 5-bit binary values (MSB:IN5...IN1:LSB); see application on page 5. Important: The optocouplers invert the input logic (input open: 1). The „ESC Y I 1“ command puts this right (input open: 0).

Example:

```
$1B $59 $52 $03
```

Reads in port IN3. The result is sent via RS232.

ESC Y W n1 n2

Write output port

Changes the output port (**n1**=1..5 = OUT1..OUT5) to the value **n2** (0=low level; 1=high level; 2=invert port). When **n1**=0, all the outputs are output as a binary value **n2** (MSB:OUT5...OUT1:LSB); see application on page 5.

Example:

```
$1B $59 $57 $02 $01
```

Switches the output port OUT2 to high level.

ESC Y A n1

Automatic port query on/off

Each change at the input port (5-bit binary value IN5..IN1) can call a port macro (0..31). This command activates (**n1**=1) or deactivates (**n1**=0) the automatic port query. After power-on, the current port status is read and the associated port macro executed immediately.

Example:

```
$1B $59 $41 $01
```

Activates the automatic port query and executes the associated port macro.

ESC Y I n1

Invert input port

This command allows the logic of the input port to be inverted (**n1**=0 for normal or **n1**=1 for inverse). This is useful with the optocoupler inputs, for example.

Example:

```
$1B $59 $49 $01
```

Inverts the input port logic.

ESC Y L n1

Switch LED illumination on/off

The LED backlighting is switched off (**n1**=0), switched on for an undefined period (**n1**=1) or inverted (**n1**=2): on->off or off->on or switched on for **n1**/10 seconds with **n1**=3..255.

Example:

```
$1B $4A $64
```

The LED backlighting comes on for 10s after this command.

ELECTRONIC ASSEMBLY

ESC Z L/Z/R x1 y1 text... NUL

Writes the string **text...** left justified (**L**), centered (**Z**) or right justified (**R**) at position **x1** taking into account the set text mode (**ESC L**). Multi-line text can also be output, with the lines separated by the character '|' (=\$7C). The string must be concluded with **NUL= \$00**. Position **y1** is the upper edge of the 1st line.

Example 1:

```
$1B $5A $4C $00 $00 $4C $65 $66 $74 $7C $4F $6B $00
```

Writes the text „Left|Ok“ left justified at 0,0.

Example 2:

```
$1B $5A $5A $19 $00 $43 $65 $6E $74 $65 $72 $7C $4F $6B $00
```

Writes the text „Center|Ok“ centered at 25,0.

Example 3:

```
$1B $5A $52 $31 $00 $52 $69 $67 $68 $74 $7C $4F $6B $00
```

Writes the text „Right|Ok“ at 49,0.

Horizontal string



ESC Z O/M/U x1 y1 text... NUL

Writes the string **text...** rotated by 90° top justified (**O**), vertically centered (**M**) or bottom justified (**U**) at position **x1** taking into account the set text mode (**ESC L**). Multi-line text can also be output, with the lines separated by the character '|' (=\$7C). The string must be concluded with **NUL= \$00**. Position **y1** is the right edge of the 1st line.

Example 1:

```
$1B $5A $4F $31 $00 $54 $6F $70 $7C $4F $6B $00
```

Writes the text „Top|Ok“ top justified at 49,0.

Example 2:

```
$1B $5A $4D $31 $0F $4D $69 $64 $7C $4F $6B $00
```

Writes the text „Mid|Ok“ vertically centered at 49,15.

Example 3:

```
$1B $5A $55 $31 $1F $42 $6F $74 $7C $4F $6B $00
```

Writes the text „Bot|Ok“ bottom justified at 49,31.

Vertical string

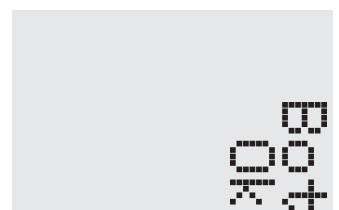
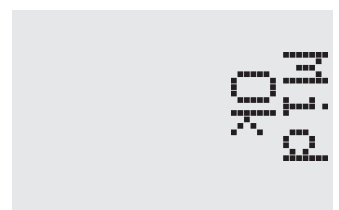
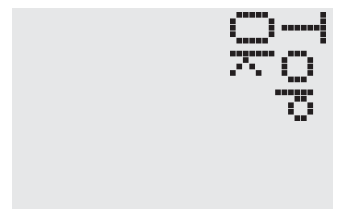

EA KIT120-5

DIMENSIONS

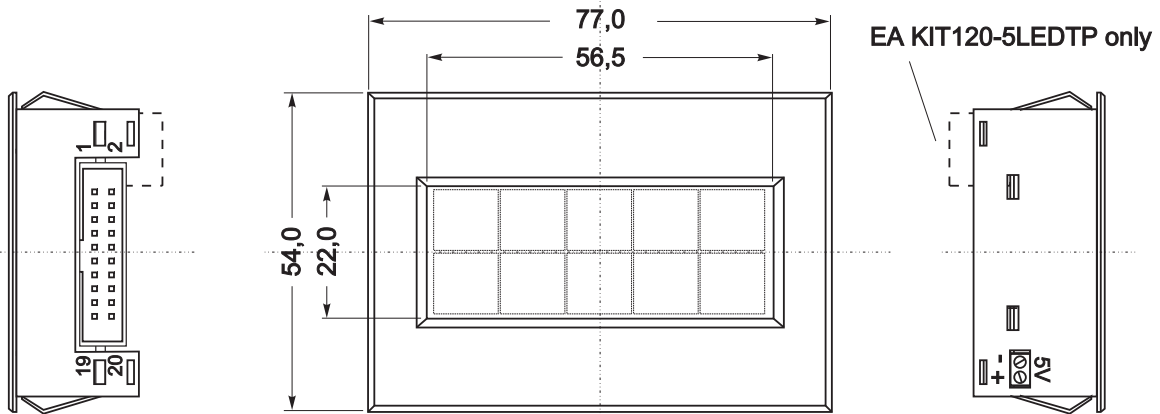

EA KIT120-5LEDTP only

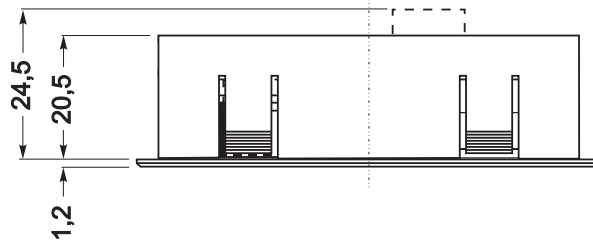

All dimensions in mm

Panel cutout: $70.5^{+0.5} \times 48.5^{+0.5}$ mm

Front panel thickness 1.5..3mm

Drawing without options

EA OPT-OPTO10: +10mm depth

EA OPT-9/36V: +13mm depth

DIMENSIONS WITHOUT HOUSING

In some applications it may make sense to take all the electronic components out of the housing. If you do this, please ensure that you do not subject the components to static electricity (ESD) when handling them.

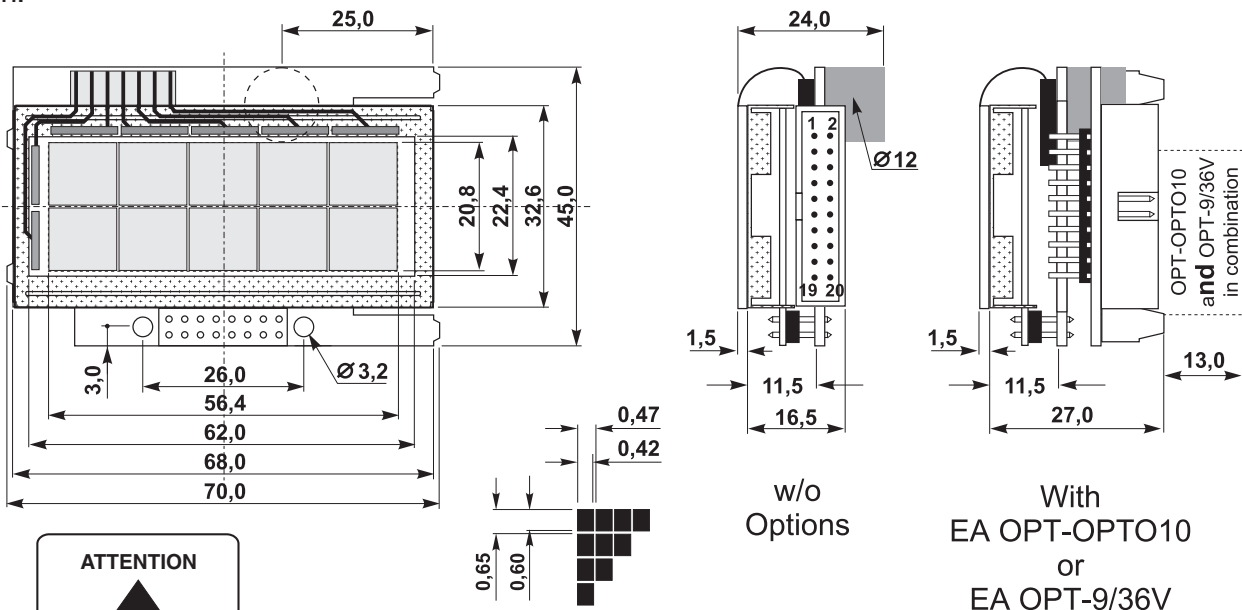

With
EA OPT-OPTO10
or
EA OPT-9/36V

all dimension in mm

Mouser Electronics

Authorized Distributor

Click to View Pricing, Inventory, Delivery & Lifecycle Information:

[ELECTRONIC ASSEMBLY:](#)

[EA KIT120-5LEDTK](#)