

Axial Lead Transient Voltage Suppressors (TVS)

20KP Series 20 To 300 V 20000W

Description

The 20KP series is designed specifically to protect sensitive electronic equipment from voltage transients induced by lightning and other transient voltage events.

Features

- u Glass passivated chip junction in P600 Package
- u Low leakage
- u Uni and Bidirectional unit
- u Excellent clamping capability
- u 20000W Peak power capability at 10 × 1000µs waveform Repetition rate (duty cycle):0.01%
- u Fast response time: typically less than 1.0ps from 0 Volts to V_{BR} min
- u Typical I_R less than 2µA above 50V.
- u High Temperature soldering: 260°C/40 seconds at terminals
- u Typical maximum temperature coefficient $\Delta V_{BR} = 0.1\% \times V_{BR}@25^\circ\text{C} \times \Delta T$
- u Plastic package has Underwriters Laboratory Flammability 94V-0
- u Matte tin lead-free Plated
- u Halogen free and RoHS compliant
- u Typical failure mode is short from over-specified voltage or current
- u Whisker test is conducted based on JEDEC JESD201A per its table 4a and 4c
- u IEC-61000-4-2 ESD 15kV(Air), 8kV (Contact)
- u ESD protection of data lines in accordance with IEC 61000-4-2 (IEC801-2)
- u EFT protection of data lines in accordance with IEC 61000-4-4 (IEC801-4)

Uni-directional

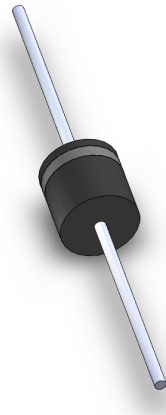

Bi-directional

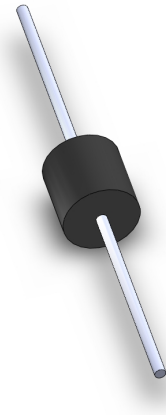

Functional Diagram

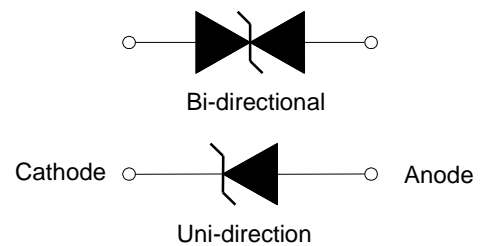

Applications

TVS devices are ideal for the protection of I/O interfaces, V_{CC} bus and other vulnerable circuits used in Telecom, Computer, Industrial and Consumer electronic applications.

Maximum Ratings ($T_A=25^\circ\text{C}$ unless otherwise noted)

Parameter	Symbol	Value	Unit
Peak Pulse Power Dissipation with a 10/1000µs waveform (Fig.1)(Note 1), (Note 2)	P_{PPM}	15000	Watts
Peak Pulse Current with a 10/1000µs waveform.(Note1, Fig.3)	I_{PP}	See Next Table	Amps
Power Dissipation on Infinite Heat Sink at $T_L=75^\circ\text{C}$	$P_{M(AV)}$	8.0	Watt
Peak Forward Surge Current, 8.3ms Single Half Sine Wave (Note 3)	I_{FSM}	500	Amps
Operating junction and Storage Temperature Range.	T_J, T_{STG}	-55 to +150	$^\circ\text{C}$

Notes:

1. Non-repetitive current pulse, per Fig. 3 and derated above $T_A = 25^\circ\text{C}$ per Fig. 2.
2. Mounted on 5.0mm x 5.0mm (0.03mm thick) Copper Pads to each terminal.
3. 8.3ms single half sine-wave, or equivalent square wave, Duty cycle = 4 pulses per minutes maximum.
4. $V_F < 3.5\text{V}$ for $V_{BR} < 200\text{V}$ and $V_F < 6.5\text{V}$ for $V_{BR} > 201\text{V}$.



Axial Lead Transient Voltage Suppressors (TVS)

20KP Series 20 To 300 V 20000W

Part Number		Reverse Stand-Off Voltage V_{RWM} (V)	Breakdown Voltage V_{BR} (V) @ I_T	Test Current I_T (mA)	Maximum Clamping Voltage V_C @ I_{PP} (V)	Maximum Peak Pulse Current I_{PP} (A)	Maximum Reverse Leakage I_R @ V_{RWM} (μ A)
Uni	Bi		MIN				
20KP20A	20KP20CA	20	22.34	50	36.8	548.9	5000
20KP24A	20KP24CA	24	26.81	50	41.2	490.3	5000
20KP26A	20KP26CA	26	29.04	50	22.7	451.9	2000
20KP28A	20KP28CA	28	31.28	50	48.0	420.8	1000
20KP30A	20KP30CA	30	33.51	5	51.5	392.2	250
20KP32A	20KP32CA	32	35.74	5	54.3	372.0	150
20KP34A	20KP34CA	34	38.00	5	57.5	351.3	50
20KP36A	20KP36CA	36	40.20	5	61.5	328.5	20
20KP40A	20KP40CA	40	44.70	5	67.8	297.9	15
20KP44A	20KP44CA	44	49.10	5	72.7	277.9	2
20KP48A	20KP48CA	48	53.60	5	79.4	254.4	2
20KP52A	20KP52CA	52	58.10	5	85.8	235.4	2
20KP56A	20KP56CA	56	62.60	5	92.6	218.1	2
20KP60A	20KP60CA	60	67.00	5	97.6	207.0	2
20KP64A	20KP64CA	64	71.50	5	104.0	194.2	2
20KP68A	20KP68CA	68	76.00	5	110.0	183.6	2
20KP72A	20KP72CA	72	80.40	5	116.0	174.1	2
20KP80A	20KP80A	80	89.40	5	130.0	155.4	2
20KP88A	20KP88CA	88	98.30	5	142.0	142.3	2
20KP96A	20KP96CA	96	107.20	5	155.0	130.3	2
20KP104A	20KP104CA	104	116.20	5	168.0	120.2	2
20KP112A	20KP112CA	112	125.10	5	182.0	111.0	2
20KP120A	20KP120CA	120	134.00	5	194.0	104.1	2
20KP132A	20KP132CA	132	147.40	5	213.0	94.8	2
20KP144A	20KP144CA	144	160.80	5	232.0	87.1	2
20KP160A	20KP160CA	160	178.70	5	258.0	78.3	2
20KP172A	20KP172CA	172	192.10	5	277.0	72.9	2
20KP180A	20KP180CA	180	201.10	5	291.0	69.4	2
20KP192A	20KP192CA	192	214.50	5	309.0	65.4	2
20KP204A	20KP204CA	204	227.90	5	329.0	61.4	2
20KP216A	20KP216CA	216	241.30	5	348.0	58.0	2
20KP232A	20KP232CA	232	159.10	5	374.0	54.0	2
20KP240A	20KP240CA	240	268.10	5	387.0	52.2	2
20KP256A	20KP256CA	256	286.00	5	412.0	49.0	2
20KP280A	20KP280CA	280	312.80	5	451.0	44.8	2
20KP300A	20KP300CA	300	335.10	5	483.0	41.8	2

Note:

- For Bi-Directional devices having V_R of 40 volts and under, the I_R limit is double

Axial Lead Transient Voltage Suppressors (TVS)

20KP Series 20 To 300 V 20000W

Ratings and Characteristic Curves ($T_A=25^\circ\text{C}$ unless otherwise noted)

Figure 1 - Peak Pulse Power Rating Curve

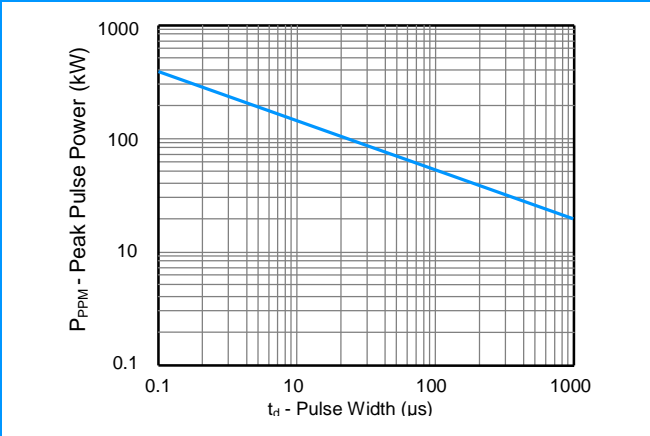

Figure 2 - Pulse Derating Curve

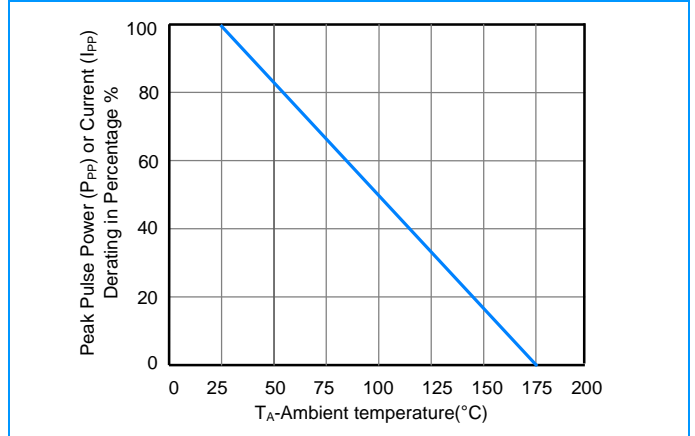

Figure 3 - Pulse Waveform

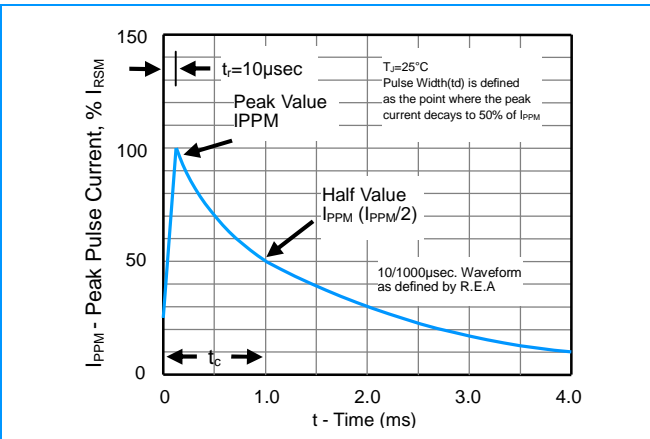

Figure 4 - Typical Junction Capacitance

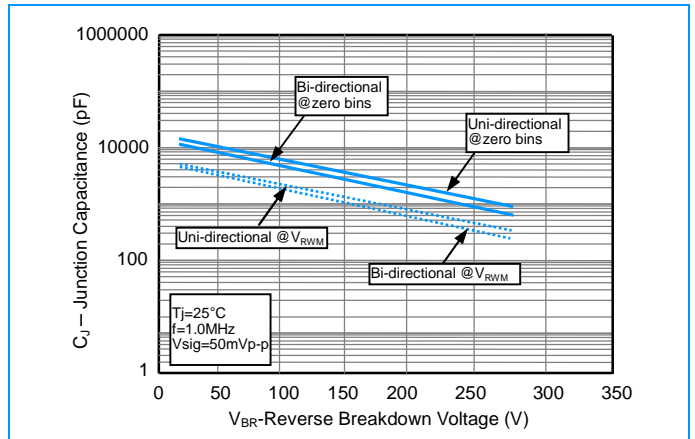

Figure 5 - Steady State Power Derating Curve

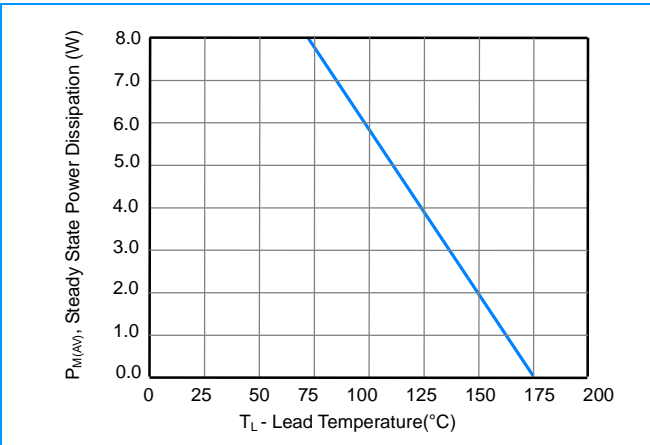
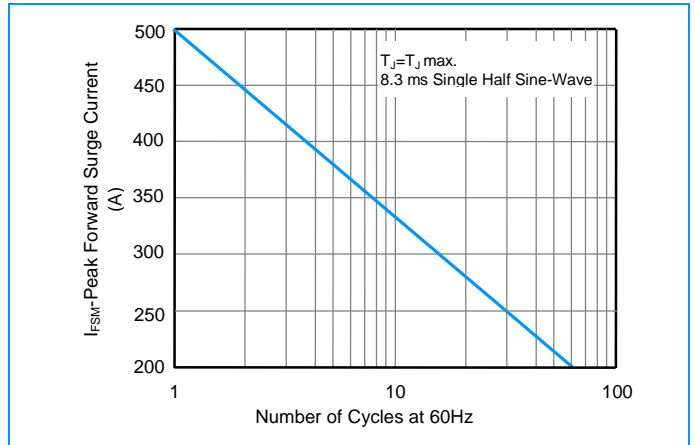

Figure 6 - Maximum Non-Repetitive Surge Current



Axial Lead Transient Voltage Suppressors (TVS)

20KP Series 20 To 300 V 20000W

I-V Curve Characteristics

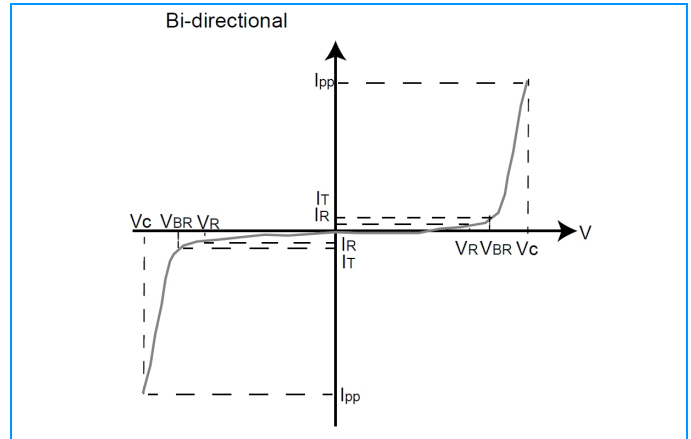
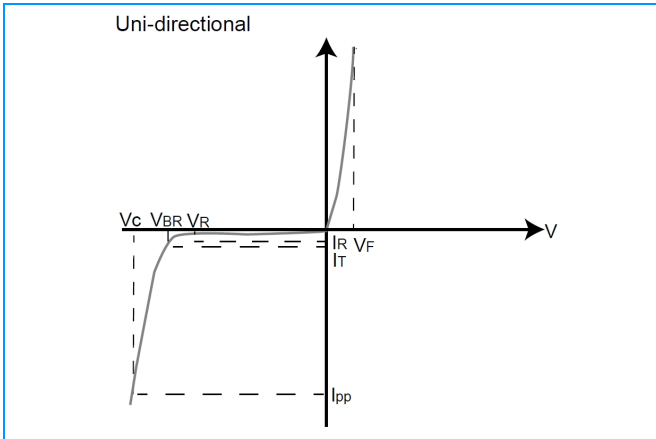

Physical Specifications

Weight	0.07 ounce, 2.1gram
Case	JEDEC R-6/P600 Molded Plastic over glass passivated junction
Polarity	Color band denotes cathode except Bipolar
Terminal	Matte Tin-plated leads, Solderable per JESD22-B102D

Environmental Specifications

Temperature Cycle	JESD22-A104
Pressure Cooker	JESD22-A102
High Temp. Storage	JESD22-A103
HTRB	JESD22-A108
Thermal Shock	JESD22-A106

Soldering Parameters

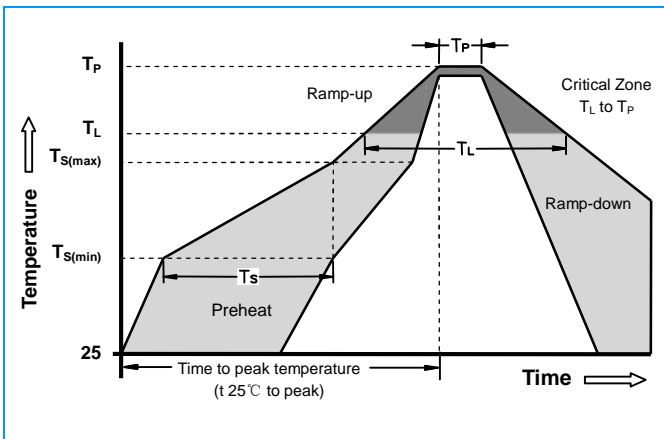

Reflow Condition		Lead-free assembly
Pre Heat	-Temperature Min ($T_{s(min)}$)	150°C
	-Temperature Max ($T_{s(max)}$)	200°C
	- Time (min to max) (t_s)	60 -180 Seconds
Average ramp up rate (Liquidus Temp T_L) to peak		3°C/second max
$T_{s(max)}$ to T_L - Ramp-up Rate		3°C/second max
Reflow	- Temperature (T_L) (Liquidus)	217°C
	- Time (min to max) (t_s)	60 -150 Seconds
Peak Temperature (T_P)		260 +0/-5°C
Time within 5°C of actual peak Temperature (t_p)		20 -40 Seconds
Ramp-down Rate		6°C/second max
Time 25°C to peak Temperature (T_P)		8 minutes Max
Do not exceed		280°C

Axial Lead Transient Voltage Suppressors (TVS)

20KP Series 20 To 300 V 20000W

Dimensions

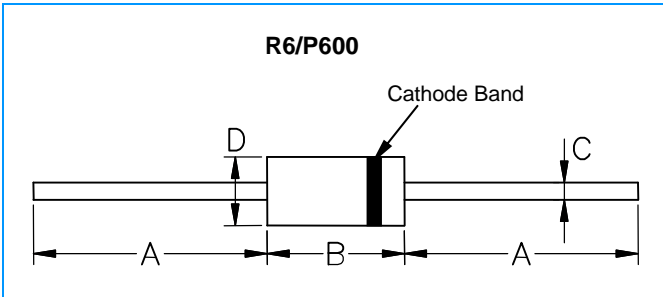

Dimensions	Inches		Millimeters	
	Min	Max	Min	Max
A	1.000	-	25.40	-
B	0.340	0.360	8.64	9.14
C	0.048	0.052	1.22	1.32
D	0.340	0.360	8.64	9.14

Part Numbering

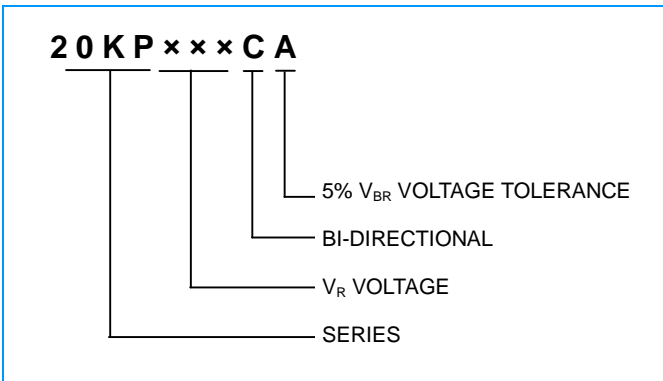

Packaging

Part Number	Component Package	Quantity	Packaging Option
20KPXXXXX	R6/P600	200	Box

Packaging Dimensions Unit: Inches (Millimeters)

