

3.5 mm×2.9 mm SMD Light Touch Switches

Type: **EVPAA**

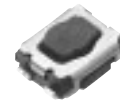

■ Features

- External dimensions : 3.5 mm×2.9 mm, Height 1.7 mm
- High operating force available
(Operating force : 5.0 N max.)
- Optional ground terminal

■ Recommended Applications

- Operation switches for portable electronic equipment
(Mobile phones, Digital still cameras, etc.)
- Operating switches for keyless entry systems

■ Explanation of Part Numbers

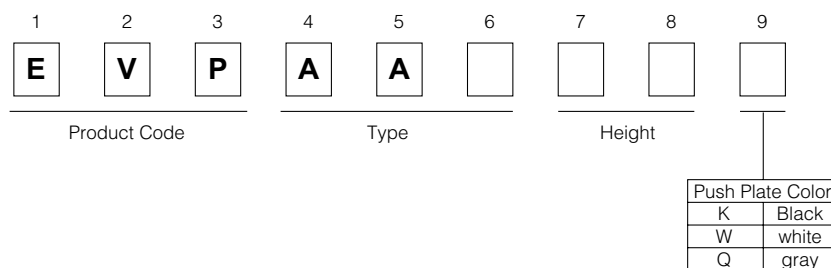

■ Specifications

Type		Snap action/Push-on type SPST
Electrical	Rating	10 μ A 2 Vdc to 20 mA 15 Vdc (Resistive load)
	Contact Resistance	100 m Ω max.
	Insulation Resistance	100 M Ω min. (at 100 Vdc)
	Dielectric Withstanding Voltage	250 Vac for 1 minute
	Bouncing	10 ms max. (ON, OFF)
Mechanical	Operating Force	1.0 N, 1.6 N, 2.4 N, 3.5 N, 5.0 N
	Travel	0.15 mm \pm 0.1 mm
Endurance	Operating Life	1000000 cycles min. (1.0 N) 200000 cycles min. (1.6 N, 2.4 N, 3.5 N) 100000 cycles min. (5.0 N)
Operating Temperature		-40 °C to +85 °C
Storage Temperature		-40 °C to +85 °C (Bulk) -20 °C to +60 °C (Taping)
Minimum Quantity/Packing Unit		5000 pcs. Embossed Taping (Reel Pack)
Quantity/Carton		25000 pcs.

Note: Non washable

Design and specifications are each subject to change without notice. Ask factory for the current technical specifications before purchase and/or use.
Should a safety concern arise regarding this product, please be sure to contact us immediately.

00 Oct. 2012

■ Dimensions in mm (not to scale)

EVPAA

(Embossed Taping)

Thickness : 1.7 mm

With J-bent terminals

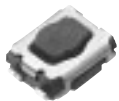

(Tolerance ± 0.2)

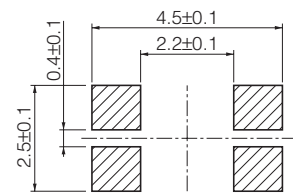
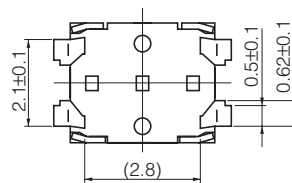
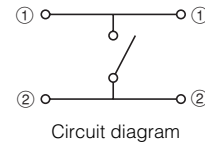
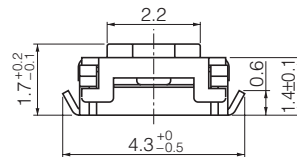
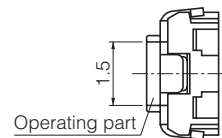
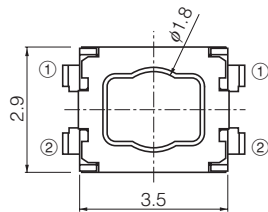

PWB land pattern for reference

Part Numbers	Ground Terminal	Operating Force	Push Plate Color	Operating Life
EVPAA002K	Without	1.0 N	Black	1000000 cycles
EVPAA102K	With	1.0 N	Black	1000000 cycles
EVPAA202K	Without	1.6 N	Black	200000 cycles
EVPAA302K	With	1.6 N	Black	200000 cycles
EVPAA402W	Without	2.4 N	White	200000 cycles
EVPAA502W	With	2.4 N	White	200000 cycles
EVPAA602W	Without	3.5 N	White	200000 cycles
EVPAA702W	With	3.5 N	White	200000 cycles
EVPAA802Q	Without	5.0 N	Grey	100000 cycles
EVPAA902Q	With	5.0 N	Grey	100000 cycles

Design and specifications are each subject to change without notice. Ask factory for the current technical specifications before purchase and/or use. Should a safety concern arise regarding this product, please be sure to contact us immediately.

Recommended Reflow Soldering Conditions

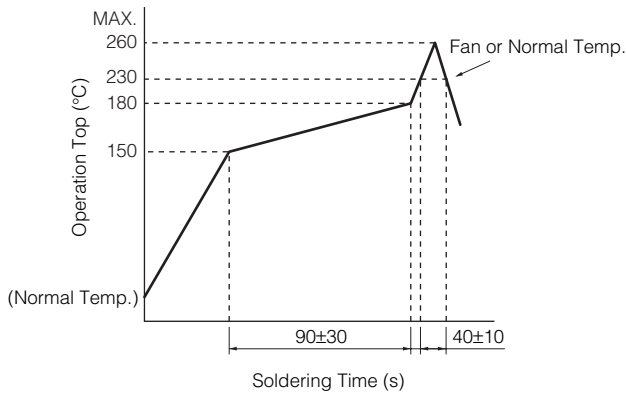

Embossed Carrier Taping

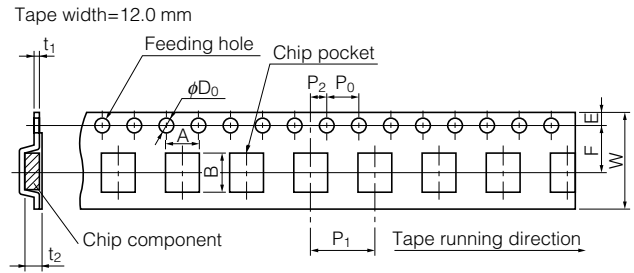

Unit: mm

Part No.	Height	A	B	W	F	E	P ₁	P ₂	P ₀	D ₀ Dia	t ₁	t ₂
EVPAA	1.7	4.5±0.2	3.8±0.2	12.0±0.3	5.5±0.1	1.75±0.10	8.0±0.1	2.0±0.1	4.0±0.1	1.5 ^{+0.1} ₋₀	0.3±0.1	1.85±0.20

Standard Reel Dimensions in mm (not to scale)

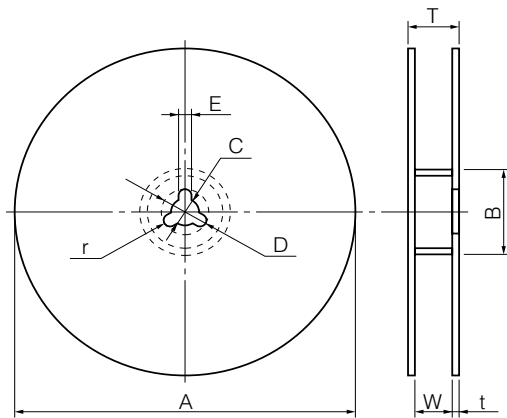

Item	A	B	C	D	E
Rate (mm)	φ380.0±2.0	φ80.0±1.0	φ13.0±0.5	φ21.0±1.0	2.0±0.5

Item	W	T	t	r
Rate (mm)	13.5±1.0	17.5±1.0	—	—

Recommended Shape of Test Pole

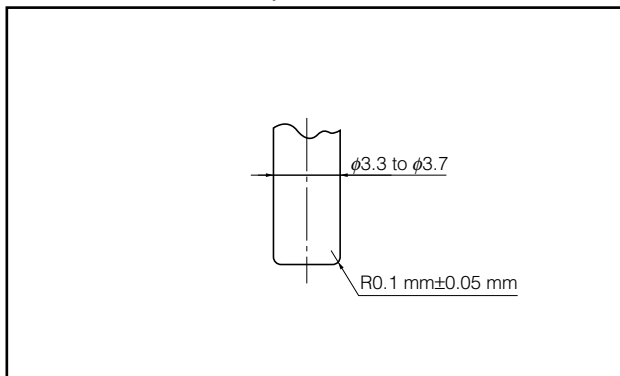

Recommended Operating Conditions

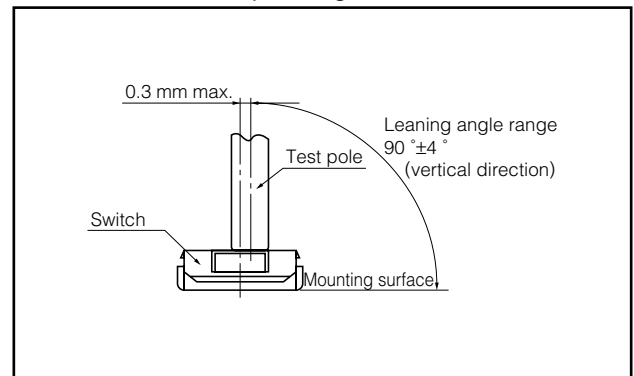

Design and specifications are each subject to change without notice. Ask factory for the current technical specifications before purchase and/or use. Should a safety concern arise regarding this product, please be sure to contact us immediately.

00 Oct. 2012