

-30V P-CHANNEL Enhancement Mode MOSFET

MTP4411M3

BV_{DSS}	-30V
I_D	-5A
R_{DS(on)}@ V_{GS}=-10V, I_D=-4A	40mΩ (typ.)
R_{DS(on)}@ V_{GS}=-4.5V, I_D=-3A	58mΩ (typ.)

Features

- Single Drive Requirement
- Ultra High Speed Switching
- Pb-free lead plating package

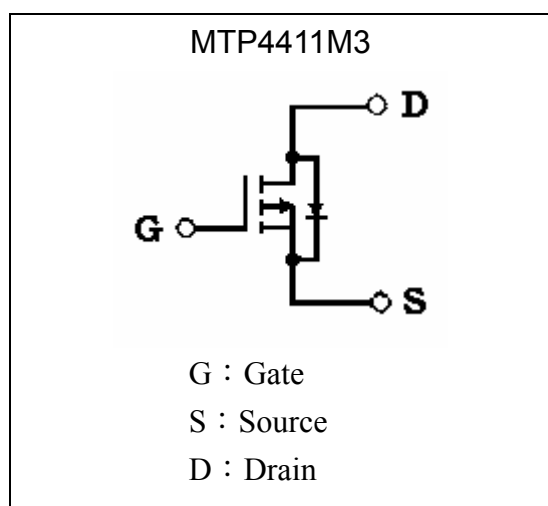
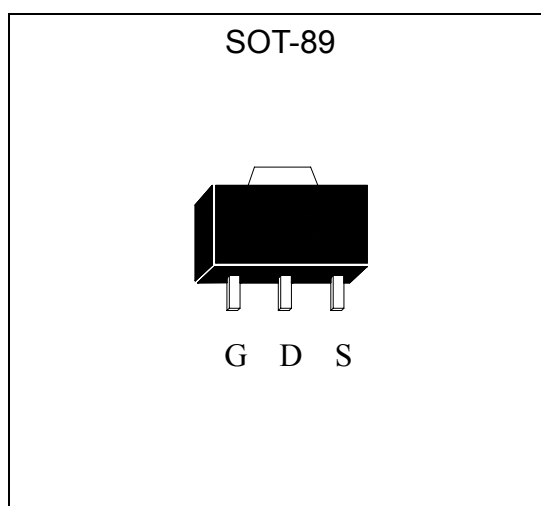
Symbol

Outline

Absolute Maximum Ratings (T_a=25°C)

Parameter	Symbol	Limits	Unit
Drain-Source Voltage	V _{DS}	-30	V
Gate-Source Voltage	V _{GS}	±20	V
Continuous Drain Current @ T _A =25°C	I _D	-5	A
Continuous Drain Current @ T _A =70°C	I _D	-4	A
Pulsed Drain Current	I _{DM}	-20 *1, 3	A
Total Power Dissipation (T _A =25°C)	P _d	1.5 *2	W
Linear Derating Factor		0.01	W/°C
Operating Junction and Storage Temperature	T _j , T _{stg}	-55~+150	°C

Note : *1. Pulse width limited by maximum junction temperature

 *2. Surface mounted on 1 in² copper pad of FR-4 board; 250 °C/W when mounted on min. copper pad

*3. Pulse width ≤ 300μs, duty cycle ≤ 2%



Thermal Data

Parameter	Symbol	Value	Unit
Thermal Resistance, Junction-to-case, max	$R_{th,j-c}$	17	°C/W
Thermal Resistance, Junction-to-ambient, max	$R_{th,j-a}$	83.3 (Note)	°C/W

Note : When mounted on a 1 in² pad of 2 oz. copper; 250 °C/W when mounted on min. copper pad

Electrical Characteristics (Tj=25°C, unless otherwise noted)

Symbol	Min.	Typ.	Max.	Unit	Test Conditions
Static					
BV_{DSS}	-30	-	-	V	$V_{GS}=0, I_D=-250\mu A$
$V_{GS(th)}$	-1	-1.4	-2.5	V	$V_{DS}=V_{GS}, I_D=-250\mu A$
G_{FS}	-	5	-	S	$V_{DS}=-10V, I_D=-4A$
I_{GSS}	-	-	±100	nA	$V_{GS}=\pm 20V, V_{DS}=0$
I_{DSS}	-	-	-1	μA	$V_{DS}=-24V, V_{GS}=0$
	-	-	-10	μA	$V_{DS}=-20V, V_{GS}=0 (T_j=125^\circ C)$
* $R_{DS(ON)}$	-	40	45	mΩ	$I_D=-4A, V_{GS}=-10V$
	-	58	75		$I_D=-3A, V_{GS}=-4.5V$
Dynamic					
C_{iss}	-	796	-	pF	$V_{DS}=-15V, V_{GS}=0, f=1MHz$
C_{oss}	-	88	-		
C_{rSS}	-	71	-		
* $t_{d(ON)}$	-	6	-	ns	$V_{DS}=-15V, I_D=-1A, V_{GS}=-10V, R_G=6\Omega$
* t_r	-	10	-		
* $t_{d(OFF)}$	-	18	-		
* t_f	-	5	-		
* Q_g	-	11	-	nC	$V_{DS}=-15V, I_D=-4A, V_{GS}=-10V$
* Q_{gs}	-	2	-		
* Q_{gd}	-	3	-		
Source-Drain Diode					
* I_S	-	-	-2.3	A	
* I_{SM}	-	-	-9.2		
* V_{SD}	-	-0.76	-1.2	V	$V_{GS}=0V, I_S=-1A$

*Pulse Test : Pulse Width ≤300μs, Duty Cycle ≤2%

Ordering Information

Device	Package	Shipping	Marking
MTP4411M3	SOT-89 (Pb-free lead plating package)	1000 pcs / Tape & Reel	4411

Typical Characteristics

Typical Output Characteristics

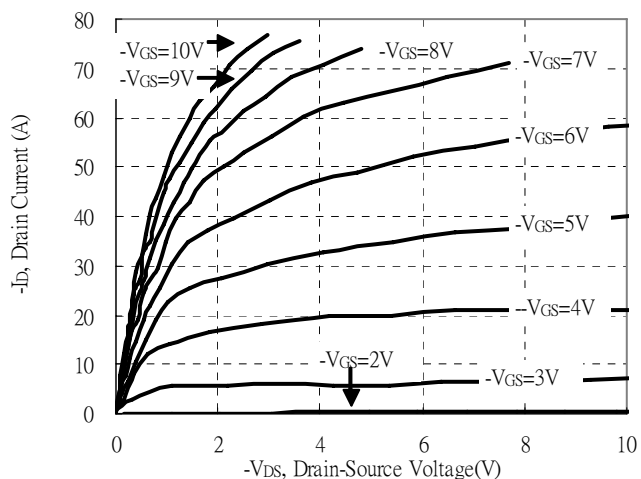

Brekdown Voltage vs Ambient Temperature

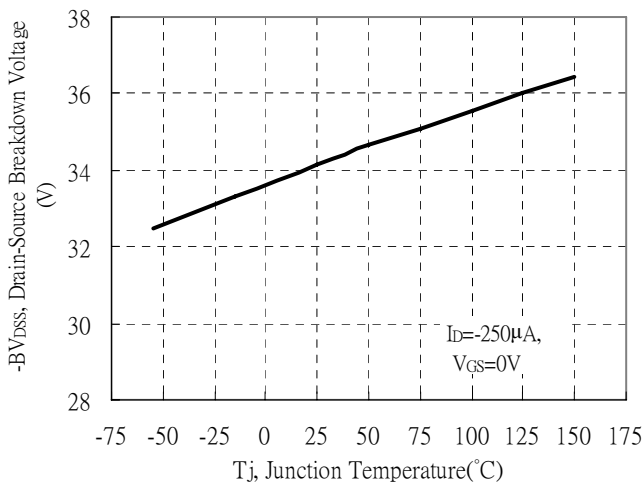

Static Drain-Source On-State resistance vs Drain Current

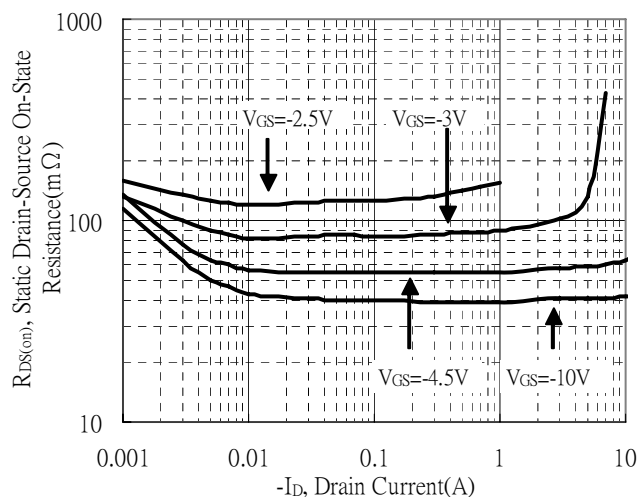

Reverse Drain Current vs Source-Drain Voltage

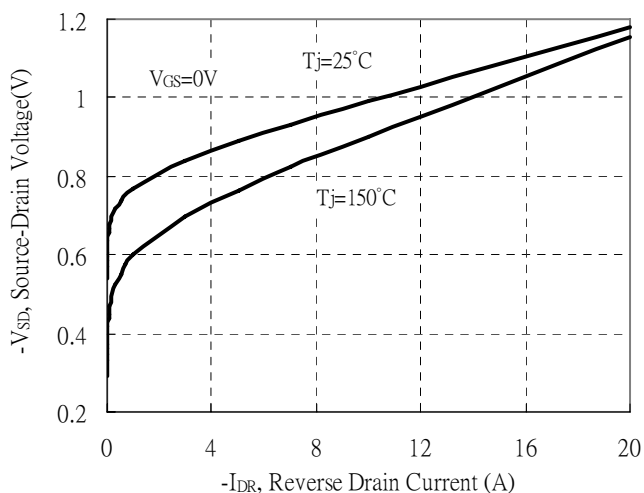

Static Drain-Source On-State Resistance vs Gate-Source Voltage

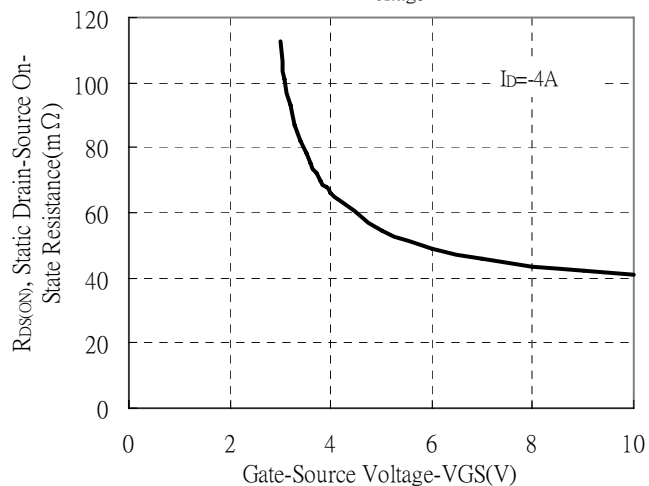

Drain-Source On-State Resistance vs Junction Temperature

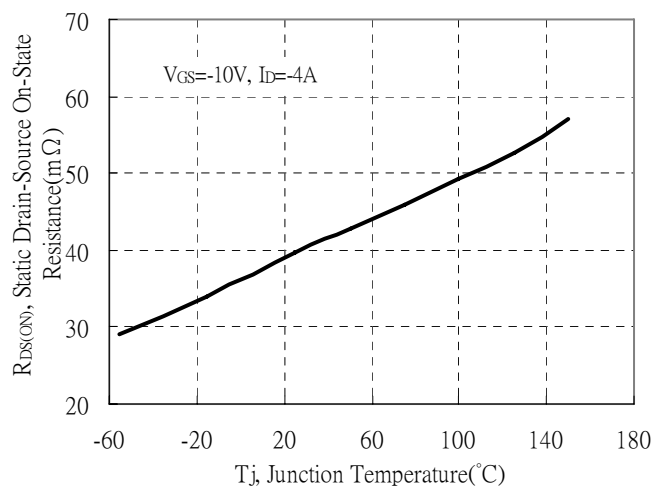

Typical Characteristics(Cont.)

Capacitance vs Drain-to-Source Voltage

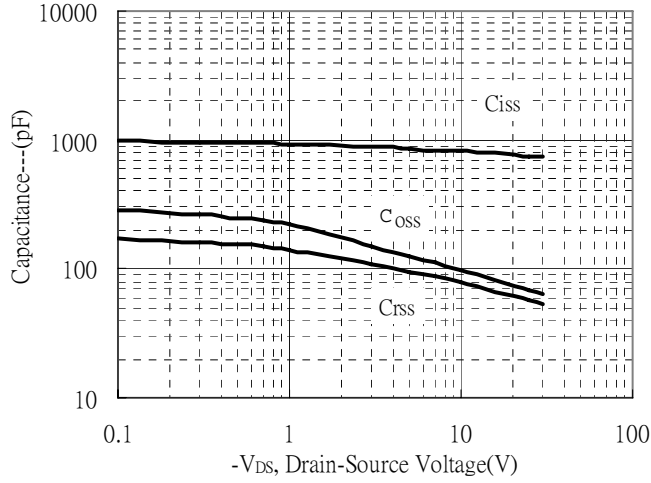

Normalized Threshold Voltage vs Junction Temperature

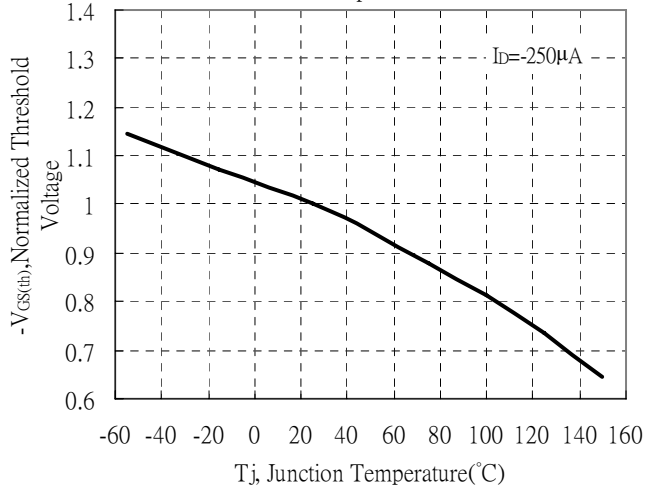

Forward Transfer Admittance vs Drain Current

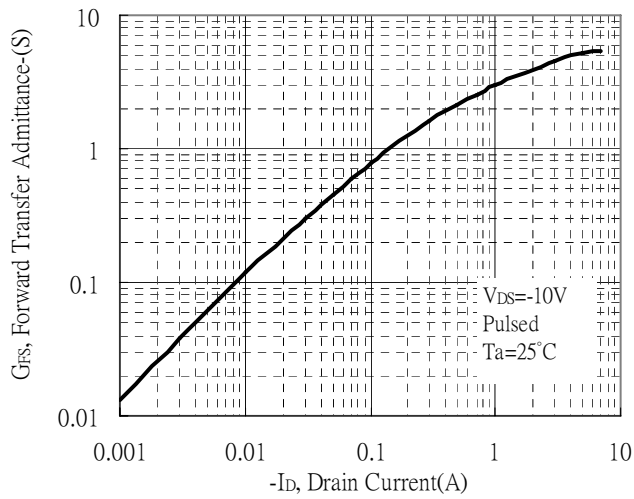

Gate Charge Characteristics

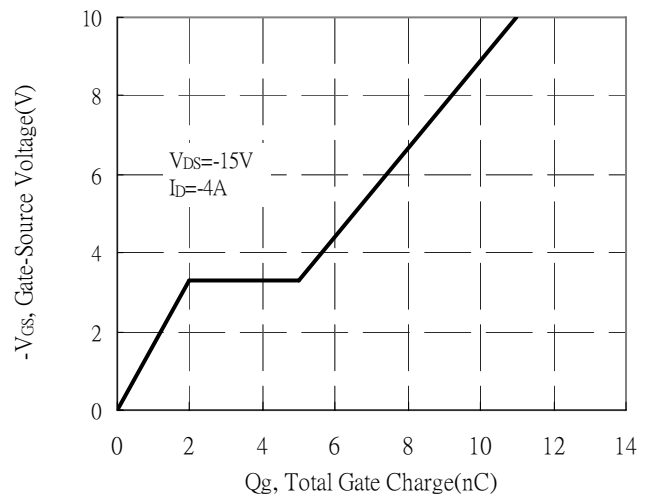

Maximum Safe Operating Area

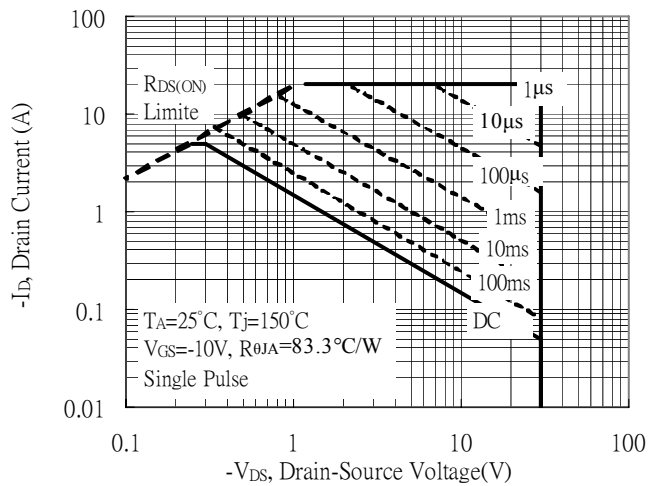

Maximum Drain Current vs Junction Temperature

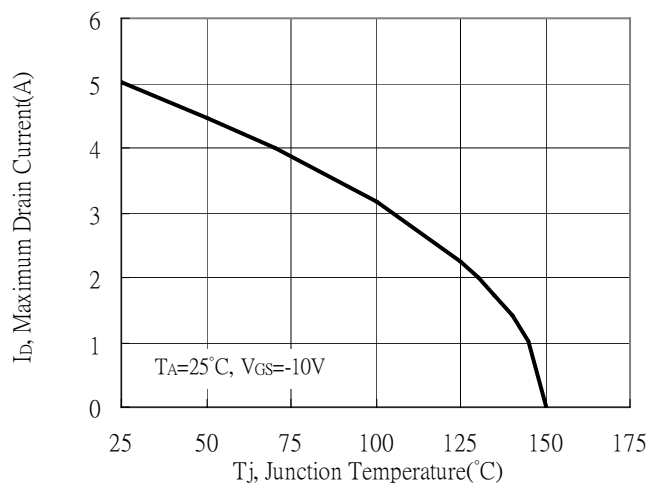

Typical Characteristics(Cont.)

Typical Transfer Characteristics

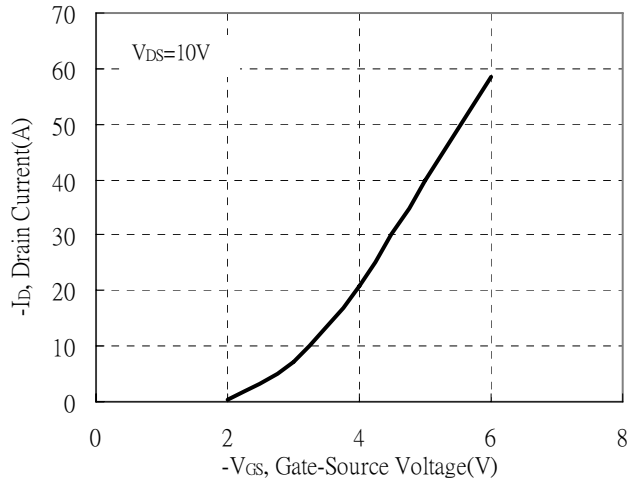

Transient Thermal Response Curves

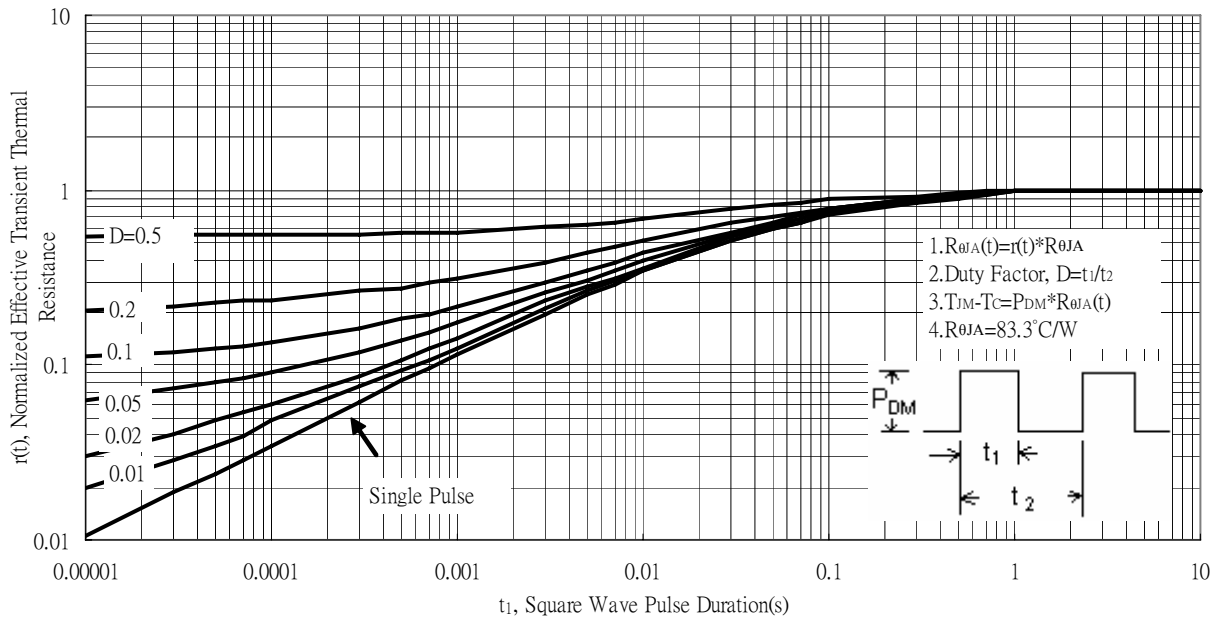

Reel Dimension

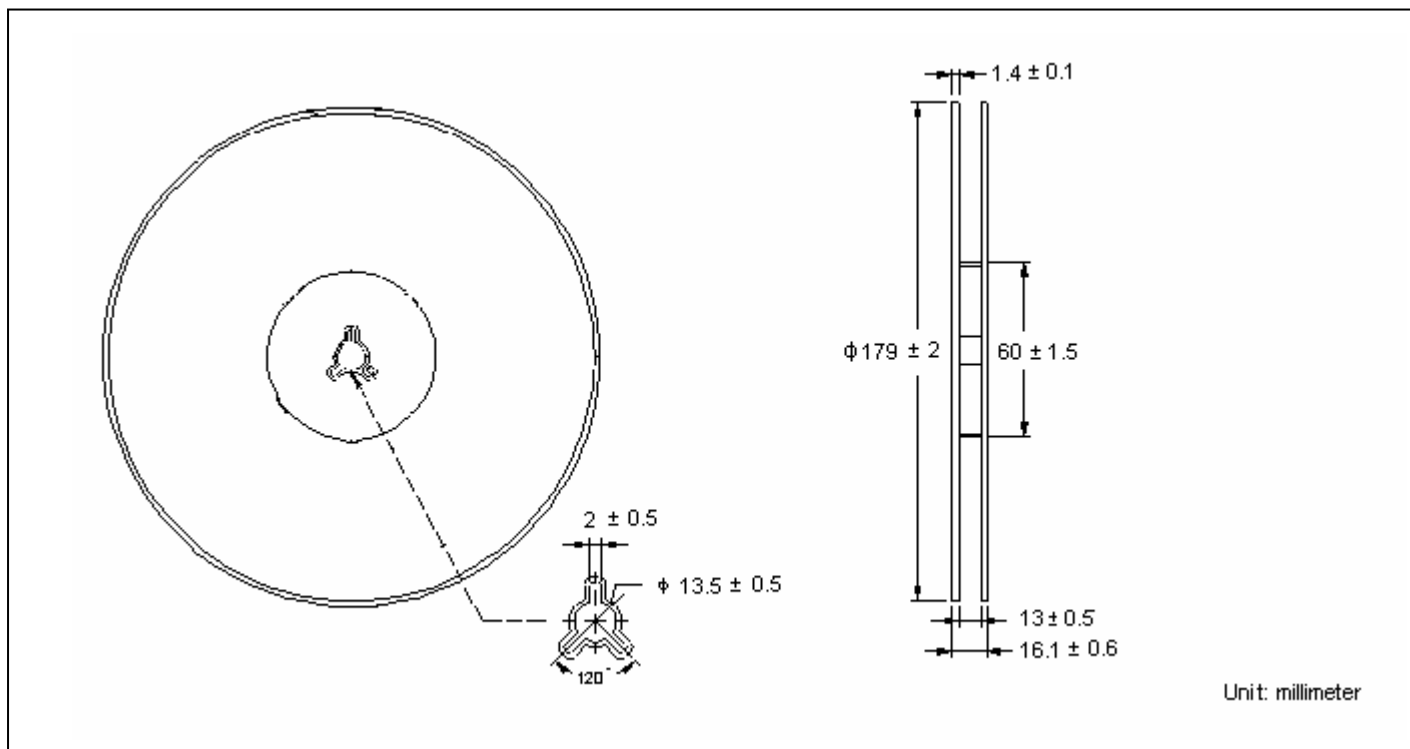

Carrier Tape Dimension

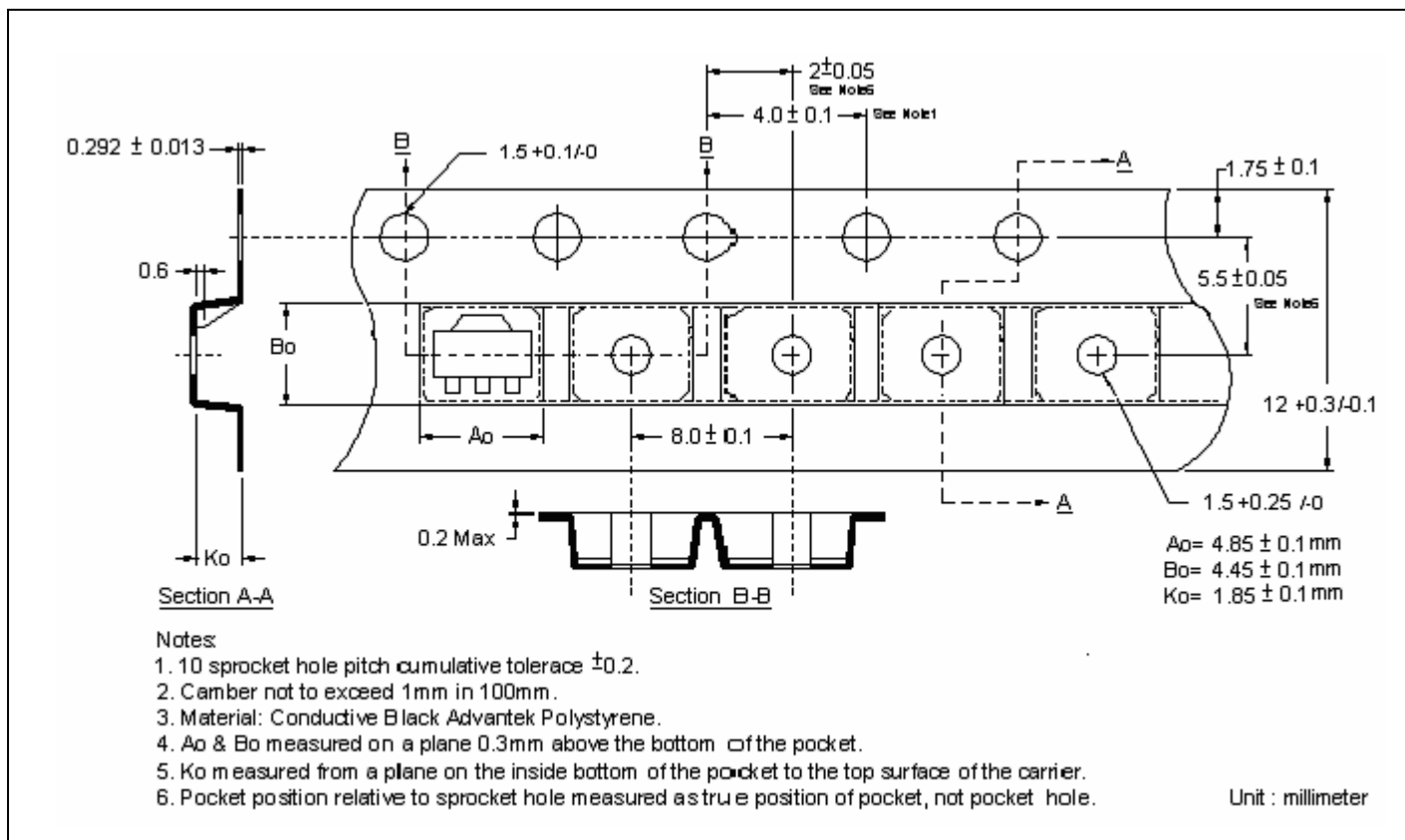

Recommended wave soldering condition

Product	Peak Temperature	Soldering Time
Pb-free devices	260 +0/-5 °C	5 +1/-1 seconds

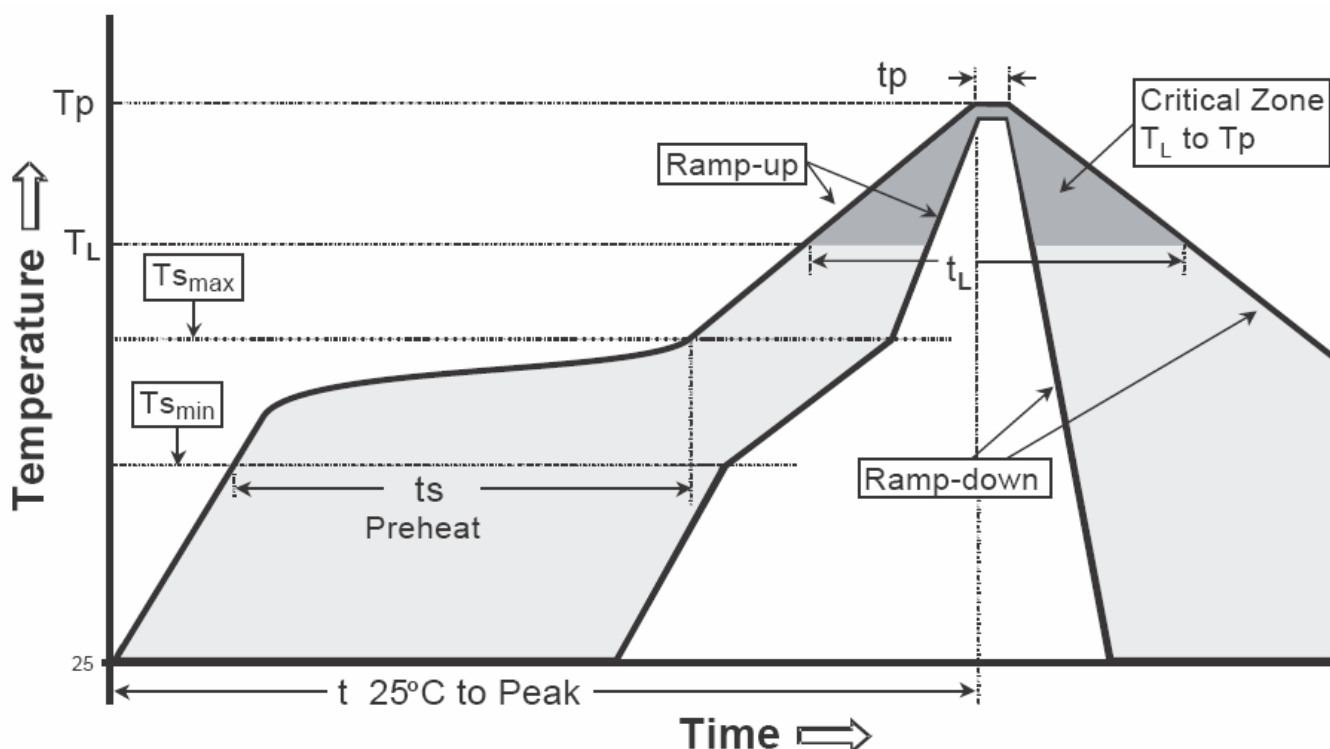
Recommended temperature profile for IR reflow

Profile feature	Sn-Pb eutectic Assembly	Pb-free Assembly
Average ramp-up rate (T _{smax} to T _p)	3°C/second max.	3°C/second max.
Preheat		
-Temperature Min(T _{s min})	100°C	150°C
-Temperature Max(T _{s max})	150°C	200°C
-Time(t _{s min} to t _{s max})	60-120 seconds	60-180 seconds
Time maintained above:		
-Temperature (T _L)	183°C	217°C
- Time (t _L)	60-150 seconds	60-150 seconds
Peak Temperature(T _P)	240 +0/-5 °C	260 +0/-5 °C
Time within 5°C of actual peak temperature(tp)	10-30 seconds	20-40 seconds
Ramp down rate	6°C/second max.	6°C/second max.
Time 25 °C to peak temperature	6 minutes max.	8 minutes max.

Note : All temperatures refer to topside of the package, measured on the package body surface.

SOT-89 Dimension

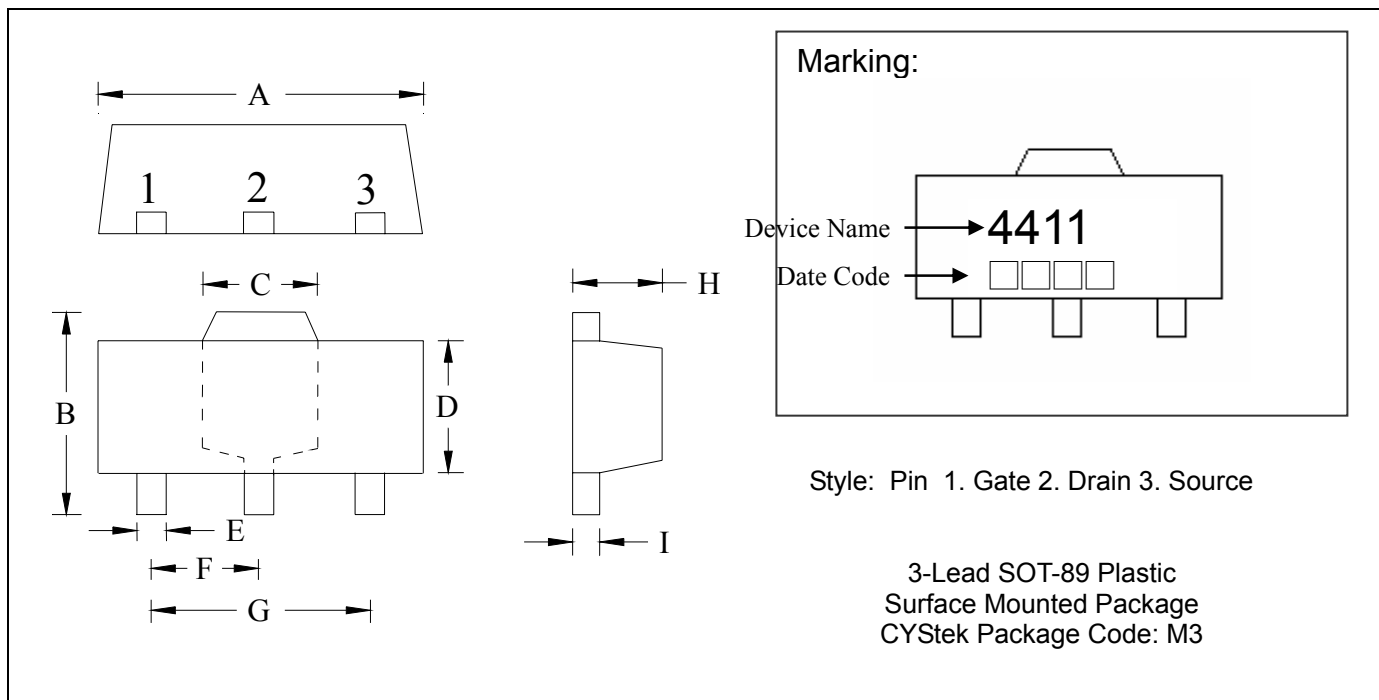

DIM	Inches		Millimeters		DIM	Inches		Millimeters	
	Min.	Max.	Min.	Max.		Min.	Max.	Min.	Max.
A	0.1732	0.1811	4.40	4.60	F	0.0591	TYP	1.50	TYP
B	0.1551	0.1673	3.94	4.25	G	0.1181	TYP	3.00	TYP
C	0.0610	REF	1.55	REF	H	0.0551	0.0630	1.40	1.60
D	0.0906	0.1024	2.30	2.60	I	0.0138	0.0173	0.35	0.44
E	0.0126	0.0205	0.32	0.52					

Notes: 1.Controlling dimension: millimeters.
 2.Maximum lead thickness includes lead finish thickness, and minimum lead thickness is the minimum thickness of base material.
 3.If there is any question with packing specification or packing method, please contact your local CYStek sales office.

Material:

- Lead: Pure tin plated.
- Mold Compound: Epoxy resin family, flammability solid burning class: UL94V-0.

Important Notice:

- All rights are reserved. Reproduction in whole or in part is prohibited without the prior written approval of CYStek.
- CYStek reserves the right to make changes to its products without notice.
- CYStek **semiconductor products are not warranted to be suitable for use in Life-Support Applications, or systems.**
- CYStek assumes no liability for any consequence of customer product design, infringement of patents, or application assistance.