

ASSEMBLED VIEW

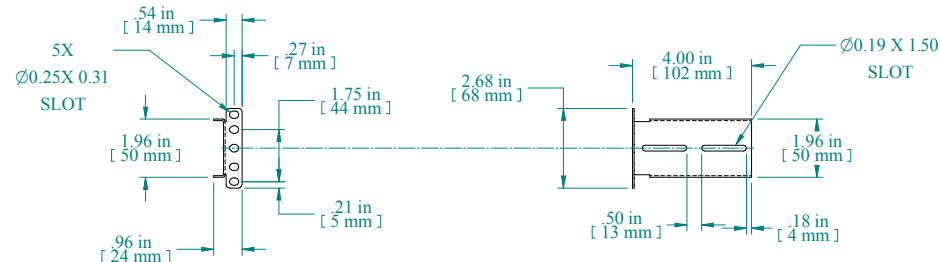

SLIDE RAIL MOUNT BRACKETS

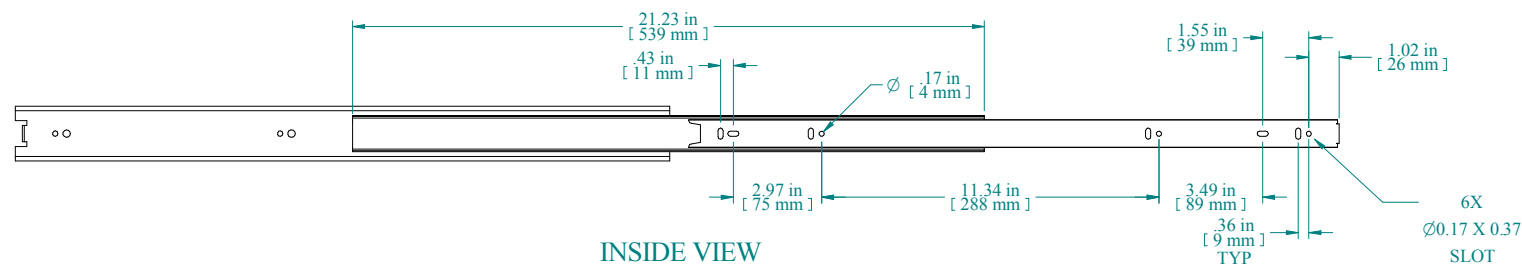

INSIDE VIEW

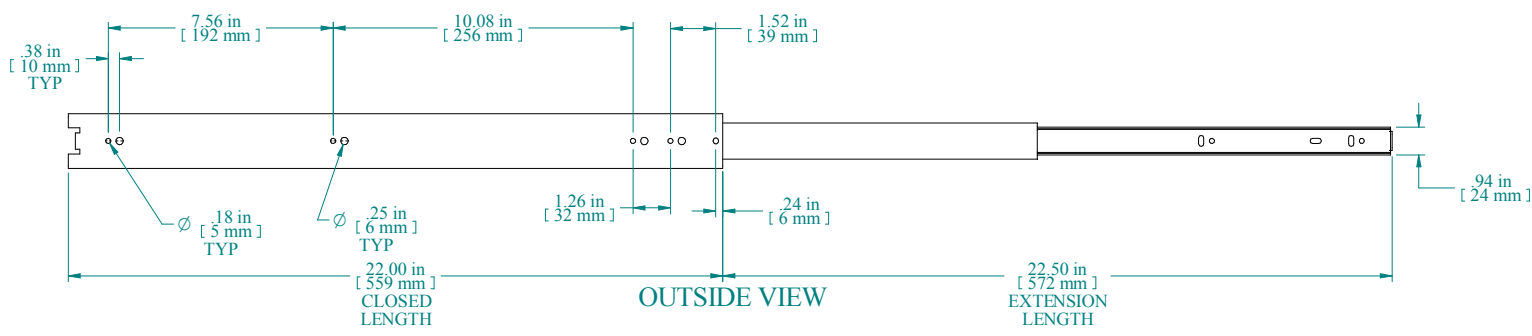
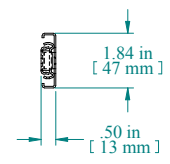

OUTSIDE VIEW

NOTES
Long life ball bearing slides
Sold in Pairs
Maximum Weight 130 lbs (Pair)
Comes with assembly hardware. 2 slides, 4 brackets
Some Assembly Required

Data subject to change without notice. Isometric drawing not to scale.



**HAMMOND  
MANUFACTURING™**

www.hammondmfg.com

PART NO. RSLIDE22