

## N-channel TO-220F MOSFET

### Features

- High ruggedness
- $R_{DS(ON)}$  (Max 2.2Ω)@ $V_{GS}=10V$
- Gate Charge (Typical 22nC)
- Improved dv/dt Capability
- 100% Avalanche Tested

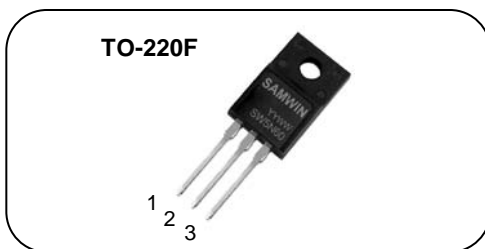

1. Gate 2. Drain 3. Source

$BV_{DSS}$  : 600V  
 $I_D$  : 5.0A  
 $R_{DS(ON)}$  : 2.2ohm

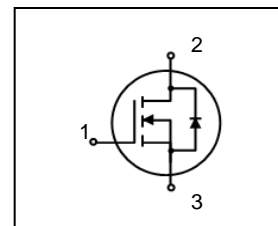

### General Description

This power MOSFET is produced with advanced VDMOS technology of SAMWIN. This technology enable power MOSFET to have better characteristics, such as fast switching time, low on resistance, low gate charge and especially excellent avalanche characteristics. This power MOSFET is usually used at high efficient DC to DC converter block and switch mode power supply.

### Order Codes

Item	Sales Type	Marking	Package	Packaging
1	SW F 5N60	SW5N60	TO-220F	TUBE

### Absolute maximum ratings

Symbol	Parameter	Value	Unit
$V_{DSS}$	Drain to Source Voltage	600	V
$I_D$	Continuous Drain Current (@ $T_C=25^{\circ}C$ )	5.0*	A
	Continuous Drain Current (@ $T_C=100^{\circ}C$ )	3.15*	A
$I_{DM}$	Drain current pulsed (note 1)	20	A
$V_{GS}$	Gate to Source Voltage	$\pm 30$	V
$E_{AS}$	Single pulsed Avalanche Energy (note 2)	135	mJ
$E_{AR}$	Repetitive Avalanche Energy (note 1)	27	mJ
dv/dt	Peak diode Recovery dv/dt (note 3)	5	V/ns
$P_D$	Total power dissipation (@ $T_C=25^{\circ}C$ )	24	W
	Derating Factor above 25°C	0.19	W/°C
$T_{STG}, T_J$	Operating Junction Temperature & Storage Temperature	-55 ~ + 150	°C
$T_L$	Maximum Lead Temperature for soldering purpose, 1/8 from Case for 5 seconds.	300	°C

\*. Drain current is limited by junction temperature.

### Thermal characteristics

Symbol	Parameter	Value	Unit
$R_{thjc}$	Thermal resistance, Junction to case	5.3	°C/W
$R_{thcs}$	Thermal resistance, Case to Sink	-	°C/W
$R_{thja}$	Thermal resistance, Junction to ambient	49	°C/W

### Electrical characteristic ( $T_C = 25^\circ\text{C}$ unless otherwise specified )

Symbol	Parameter	Test conditions	Min.	Typ.	Max.	Unit
<b>Off characteristics</b>						
$BV_{DSS}$	Drain to source breakdown voltage	$V_{GS}=0V, I_D=250\mu A$	600			V
$\Delta BV_{DSS} / \Delta T_J$	Breakdown voltage temperature coefficient	$I_D=250\mu A$ , referenced to $25^\circ\text{C}$		0.59		V/ $^\circ\text{C}$
$I_{DSS}$	Drain to source leakage current	$V_{DS}=600V, V_{GS}=0V$			1	$\mu A$
		$V_{DS}=480V, T_C=125^\circ\text{C}$			50	$\mu A$
$I_{GSS}$	Gate to source leakage current, forward	$V_{GS}=30V, V_{DS}=0V$			100	nA
	Gate to source leakage current, reverse	$V_{GS}=-30V, V_{DS}=0V$			-100	nA
<b>On characteristics</b>						
$V_{GS(TH)}$	Gate threshold voltage	$V_{DS}=V_{GS}, I_D=250\mu A$	2.0		4.0	V
$R_{DS(ON)}$	Drain to source on state resistance	$V_{GS}=10V, I_D = 2.5A$		1.9	2.2	$\Omega$
$G_{fs}$	Forward Transconductance	$V_{DS} = 20 V, I_D = 2.5 A$	3			S
<b>Dynamic characteristics</b>						
$C_{iss}$	Input capacitance	$V_{GS}=0V, V_{DS}=25V, f=1\text{MHz}$		630		pF
$C_{oss}$	Output capacitance			65		
$C_{riss}$	Reverse transfer capacitance			22		
$t_{d(on)}$	Turn on delay time	$V_{DS}=300V, I_D=5.0A, R_G=25\Omega$ (note 4,5)		13	25	ns
$t_r$	Rising time			25	50	
$t_{d(off)}$	Turn off delay time			39	80	
$t_f$	Fall time			23	50	
$Q_g$	Total gate charge	$V_{DS}=480V, V_{GS}=10V, I_D=5.0A$ (note 4,5)		22	50	nC
$Q_{gs}$	Gate-source charge			4		
$Q_{gd}$	Gate-drain charge			10		

### Source to drain diode ratings characteristics

Symbol	Parameter	Test conditions	Min.	Typ.	Max.	Unit
$I_S$	Continuous source current	Integral reverse p-n Junction diode in the MOSFET			5	A
$I_{SM}$	Pulsed source current				20	A
$V_{SD}$	Diode forward voltage drop.	$I_S=5.0A, V_{GS}=0V$			1.5	V
$T_{rr}$	Reverse recovery time	$I_S=5.0A, V_{GS}=0V,$		267		ns
$Q_{rr}$	Reverse recovery Charge	$dI_F/dt=100A/\mu s$		2.3		$\mu C$

#### ※. Notes

1. Repetitive rating : pulse width limited by junction temperature.
2.  $L = 11\text{mH}, I_{AS} = 5A, V_{DD} = 50V, R_G=25\Omega$ , Starting  $T_J = 25^\circ\text{C}$
3.  $I_{SD} \leq 5.0A, di/dt = 100A/\mu s, V_{DD} \leq BV_{DSS}$ , Starting  $T_J = 25^\circ\text{C}$
4. Pulse Test : Pulse Width  $\leq 300\mu s$ , duty cycle  $\leq 2\%$
5. Essentially independent of operating temperature.

Fig. 1. On-state characteristics

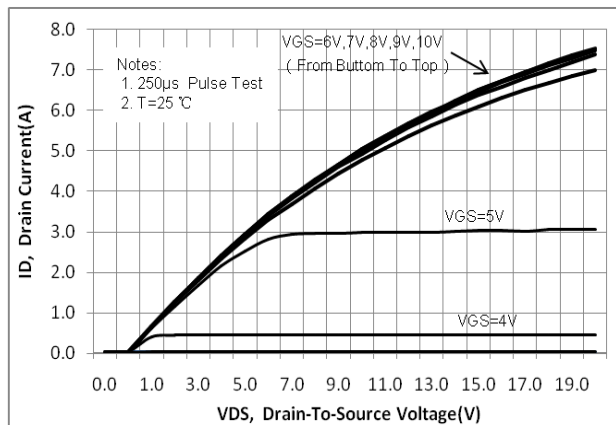

Fig. 2. On-resistance variation vs. drain current and gate voltage

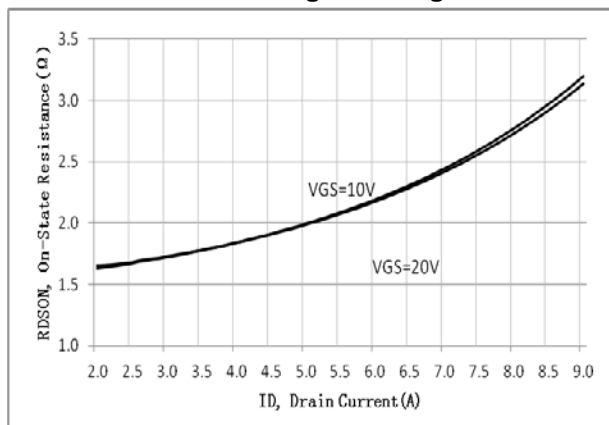

Fig. 3. Gate charge characteristics

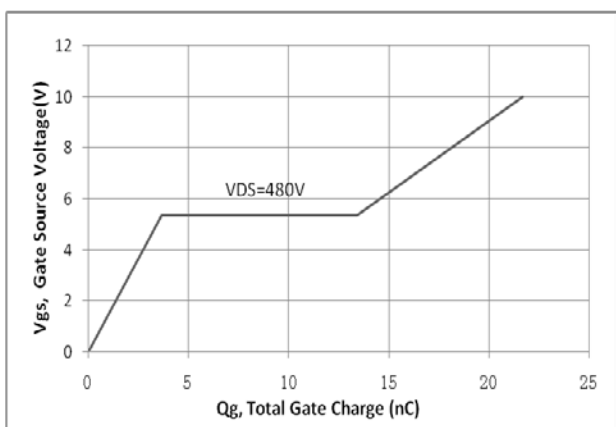

Fig. 4. On state current vs. diode forward voltage

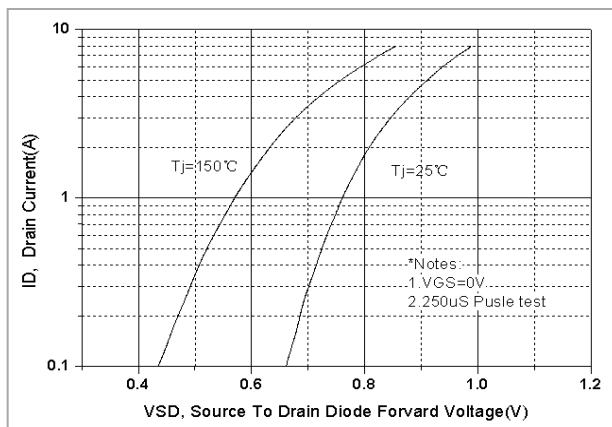

Fig 5. Breakdown Voltage Variation vs. Junction Temperature

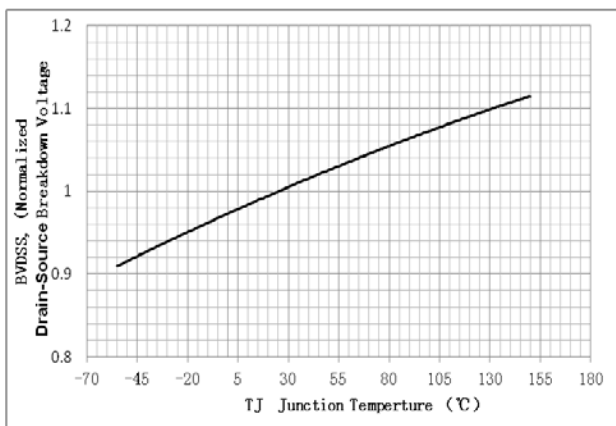

Fig. 6. On resistance variation vs. junction temperature

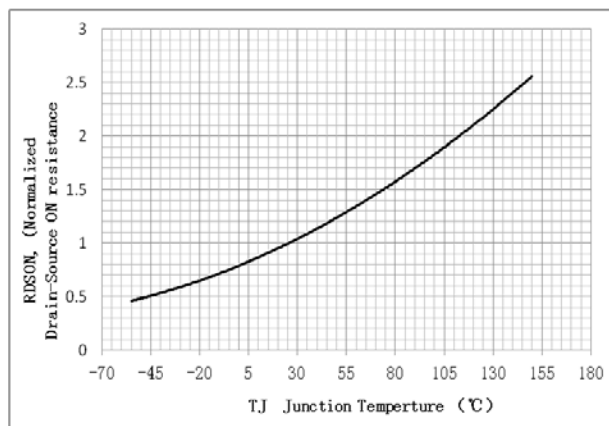

Fig. 7. Maximum safe operating area

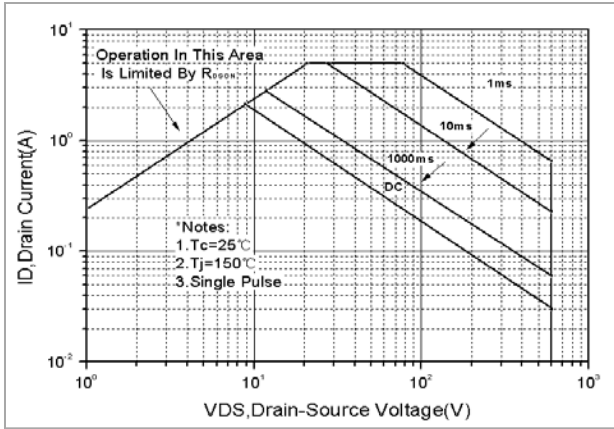

Fig. 8. Transient thermal response curve

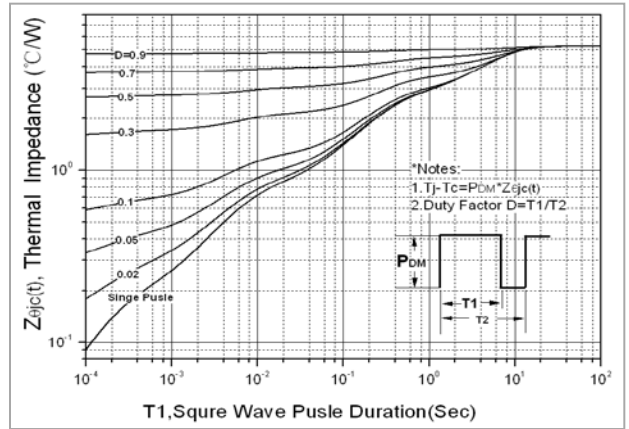

Fig. 9. Gate charge test circuit & waveform

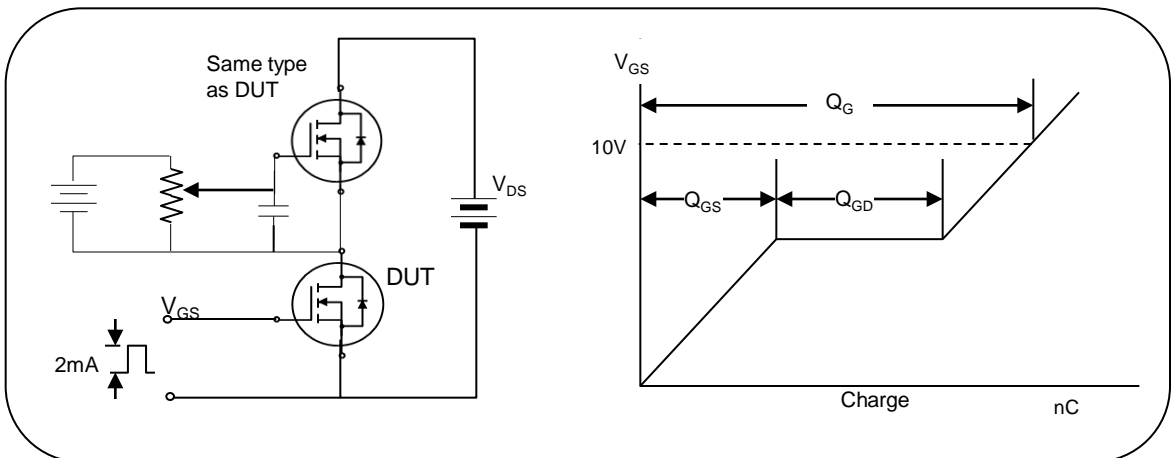

Fig. 10. Switching time test circuit & waveform

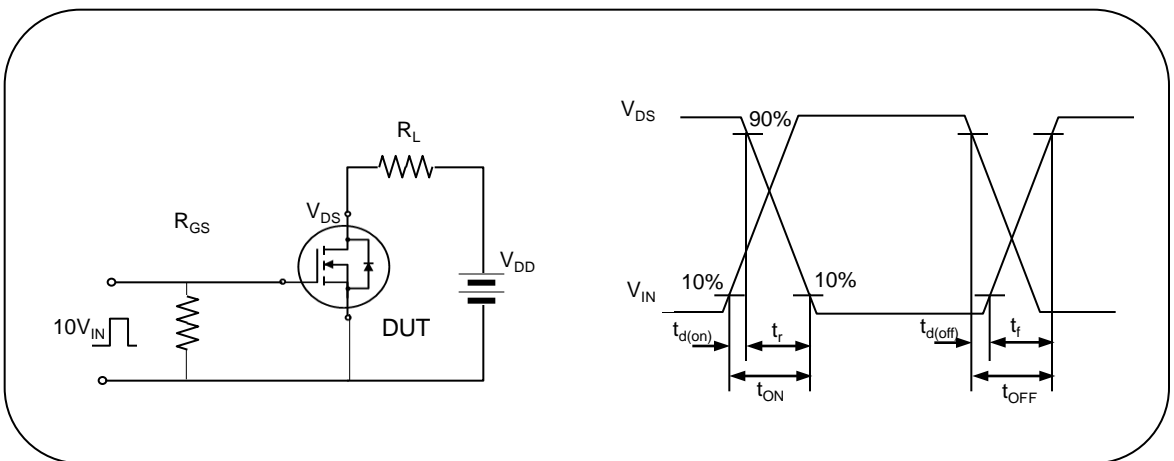

Fig. 11. Unclamped Inductive switching test circuit & waveform

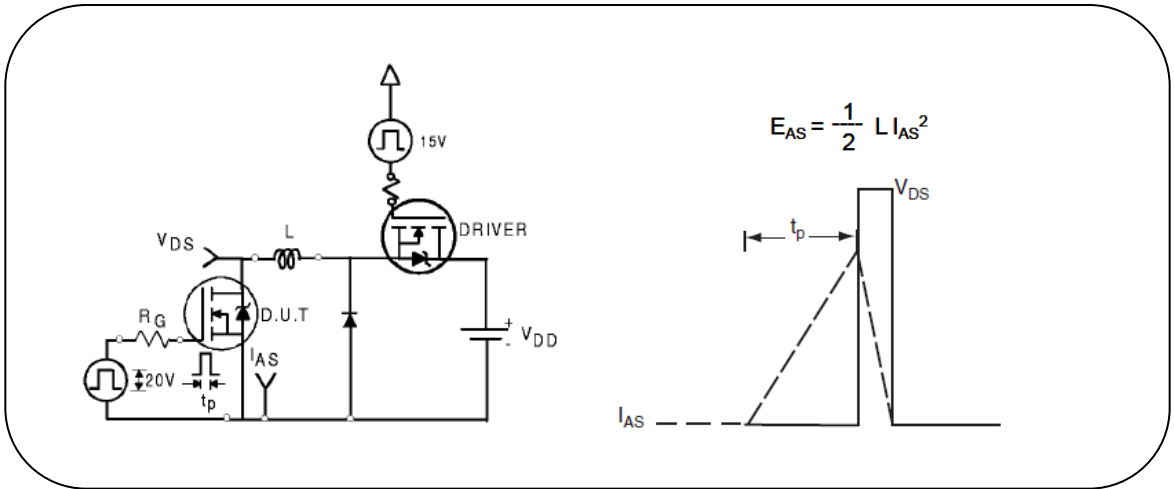

Fig. 12. Peak diode recovery dv/dt test circuit & waveform

