

TLV271

Single-Channel, Rail-to-Rail Output, 3 MHz BW Operational Amplifier

The TLV271 operational amplifier provides rail-to-rail output operation. The output can swing within 320 mV to the positive rail and 50 mV to the negative rail. This rail-to-rail operation enables the user to make optimal use of the entire supply voltage range while taking advantage of 3 MHz bandwidth. The TLV271 can operate on supply voltage as low as 2.7 V over the temperature range of -40°C to 105°C . The high bandwidth provides a slew rate of $2.4\text{ V}/\mu\text{s}$ while only consuming $550\ \mu\text{A}$ of quiescent current. Likewise the TLV271 can run on a supply voltage as high as 16 V making it ideal for a broad range of battery-operated applications. Since this is a CMOS device it has high input impedance and low bias currents making it ideal for interfacing to a wide variety of signal sensors. In addition it comes in a small TSOP-5 package with two pinout styles allowing for use in high-density PCB's.

Features

- Rail-To-Rail Output
- Wide Bandwidth: 3 MHz
- High Slew Rate: $2.4\text{ V}/\mu\text{s}$
- Wide Power-Supply Range: 2.7 V to 16 V
- Low Supply Current: $550\ \mu\text{A}$
- Low Input Bias Current: 45 pA
- Wide Temperature Range: -40°C to 105°C
- Small Package: 5 Pin TSOP-5 (same as SOT23-5)
- These Devices are Pb-Free, Halogen Free/BFR Free and are RoHS Compliant

Applications

- Notebook Computers
- Portable Instruments



ON Semiconductor®

<http://onsemi.com>



TSOP-5
(SOT23-5)
SN SUFFIX
CASE 483

MARKING DIAGRAM

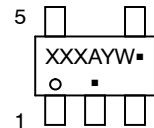

XXX = ADG (TLV271SN1T1G)
= ADH (TLV271SN2T1G)
A = Assembly Location
Y = Year
W = Work Week
▪ = Pb-Free Package

(Note: Microdot may be in either location)

PIN CONNECTIONS

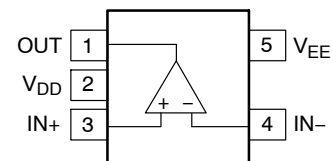

Style 1 Pinout (SN1T1)
(Top View)

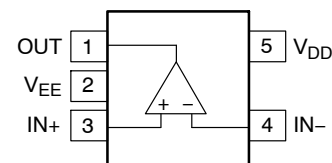

Style 2 Pinout (SN2T1)
(Top View)

ORDERING INFORMATION

Device	Package	Shipping†
TLV271SN1T1G (Style 1 Pinout)	TSOP-5 (Pb-Free)	3000 / Tape & Reel
TLV271SN2T1G (Style 2 Pinout)	TSOP-5 (Pb-Free)	3000 / Tape & Reel

†For information on tape and reel specifications, including part orientation and tape sizes, please refer to our Tape and Reel Packaging Specifications Brochure, BRD8011/D.

MAXIMUM RATINGS

Symbol	Rating	Value	Unit
V _{DD}	Supply Voltage (Note 1)	16.5	V
V _{ID}	Input Differential Voltage (Note 2)	± Supply Voltage	V
V _I	Input Common Mode Voltage Range (Note 1)	-0.2 V to (V _{DD} + 0.2 V)	V
I _I	Maximum Input Current	± 10	mA
I _O	Output Current Range	± 100	mA
	Continuous Total Power Dissipation (Note 1)	200	mW
T _J	Maximum Junction Temperature	150	°C
θ _{JA}	Thermal Resistance	333	°C/W
T _{stg}	Operating Temperature Range (free-air)	-40 to 105	°C
T _{stg}	Storage Temperature	-65 to 150	°C
	Mounting Temperature (Infrared or Convection – 20 sec)	260	°C

Stresses exceeding Maximum Ratings may damage the device. Maximum Ratings are stress ratings only. Functional operation above the Recommended Operating Conditions is not implied. Extended exposure to stresses above the Recommended Operating Conditions may affect device reliability.

1. Continuous short-circuit operation to ground at elevated ambient temperature can result in exceeding the maximum allowed junction temperature of 150°C. Output currents in excess of 45 mA over long term may adversely affect reliability. Shorting output to either V₊ or V₋ will adversely affect reliability.
2. ESD data available upon request.

DC ELECTRICAL CHARACTERISTICS (V_{DD} = 2.7V, 3.3V, 5V & ± 5 V (Note 3), T_A = 25°C, R_L ≥ 10 kΩ unless otherwise noted)

Parameter	Symbol	Conditions	Min	Typ	Max	Unit
Input Offset Voltage	V _{IO}	VIC = V _{DD} /2, V _O = V _{DD} /2, R _L = 10 kΩ, R _S = 50 Ω		0.5	5	mV
		T _A = -40°C to +105°C			7	
Offset Voltage Drift	ICV _{OS}	VIC = V _{DD} /2, V _O = V _{DD} /2, R _L = 10 kΩ, R _S = 50 Ω		2		μV/°C
Common Mode Rejection Ratio	CMRR	0 V ≤ VIC ≤ V _{DD} - 1.35 V, R _S = 50 Ω	V _{DD} = 2.7 V	58	70	dB
		T _A = -40°C to +105°C		55		
		0 V ≤ VIC ≤ V _{DD} - 1.35 V, R _S = 50 Ω	V _{DD} = 5 V	65	130	
		T _A = -40°C to +105°C		62		
Power Supply Rejection Ratio	PSRR	V _{DD} = 2.7 V to 16 V, VIC = V _{DD} /2, No Load	70	135		dB
		T _A = -40°C to +105°C				
Large Signal Voltage Gain	A _{VD}	V _{O(pp)} = V _{DD} /2, R _L = 10 kΩ	V _{DD} = 2.7 V	97	106	dB
		T _A = -40°C to +105°C		76		
		V _{O(pp)} = V _{DD} /2, R _L = 10 kΩ	V _{DD} = 3.3 V	97	123	
		T _A = -40°C to +105°C		76		
		V _{O(pp)} = V _{DD} /2, R _L = 10 kΩ	V _{DD} = 5 V	100	127	
		T _A = -40°C to +105°C		86		
Input Bias Current	I _B	V _{DD} = 5 V, VIC = V _{DD} /2, V _O = V _{DD} /2, R _S = 50 Ω	T _A = 25°C	45	150	pA
		T _A = 105°C			1000	

3. V_{DD} = ±5 V is shorthand for V_{DD} = +5 V and V_{EE} = -5 V.

TLV271

DC ELECTRICAL CHARACTERISTICS ($V_{DD} = 2.7V, 3.3V, 5V$ & $\pm 5V$ (Note 3), $T_A = 25^\circ C$, $R_L \geq 10\text{ k}\Omega$ unless otherwise noted)

Parameter	Symbol	Conditions	Min	Typ	Max	Unit	
Input Offset Current	I_{IO}	$V_{DD} = 5\text{ V}$, $V_{IC} = V_{DD}/2$, $V_O = V_{DD}/2$, $R_S = 50\ \Omega$	$T_A = 25^\circ C$		45	150	pA
			$T_A = 105^\circ C$			1000	
Differential Input Resistance	$r_{i(d)}$			1000		G Ω	
Common-mode Input Capacitance	C_{IC}	$f = 21\text{ kHz}$		8		pF	
Output Swing (High-level)	V_{OH}	$V_{IC} = V_{DD}/2$, $I_{OH} = -1\text{ mA}$	$V_{DD} = 2.7\text{ V}$	2.55	2.58		V
		$T_A = -40^\circ C$ to $+105^\circ C$		2.48			
		$V_{IC} = V_{DD}/2$, $I_{OH} = -1\text{ mA}$	$V_{DD} = 3.3\text{ V}$	3.15	3.21		
		$T_A = -40^\circ C$ to $+105^\circ C$		3.00			
		$V_{IC} = V_{DD}/2$, $I_{OH} = -1\text{ mA}$	$V_{DD} = 5\text{ V}$	4.8	4.93		
		$T_A = -40^\circ C$ to $+105^\circ C$		4.75			
		$V_{IC} = V_{DD}/2$, $I_{OH} = -1\text{ mA}$	$V_{DD} = \pm 5\text{ V}$	4.92	4.96		
		$T_A = -40^\circ C$ to $+105^\circ C$		4.9			
		$V_{IC} = V_{DD}/2$, $I_{OH} = -5\text{ mA}$	$V_{DD} = 2.7\text{ V}$	1.9	2.1		V
		$T_A = -40^\circ C$ to $+105^\circ C$		1.5			
		$V_{IC} = V_{DD}/2$, $I_{OH} = -5\text{ mA}$	$V_{DD} = 3.3\text{ V}$	2.5	2.89		
		$T_A = -40^\circ C$ to $+105^\circ C$		2.1			
		$V_{IC} = V_{DD}/2$, $I_{OH} = -5\text{ mA}$	$V_{DD} = 5\text{ V}$	4.5	4.68		
		$T_A = -40^\circ C$ to $+105^\circ C$		4.35			
		$V_{IC} = V_{DD}/2$, $I_{OH} = -5\text{ mA}$	$V_{DD} = \pm 5\text{ V}$	4.7	4.78		
		$T_A = -40^\circ C$ to $+105^\circ C$		4.65			
Output Swing (Low-level)	V_{OL}	$V_{IC} = V_{DD}/2$, $I_{OL} = -1\text{ mA}$	$V_{DD} = 2.7\text{ V}$		0.1	0.15	V
		$T_A = -40^\circ C$ to $+105^\circ C$				0.22	
		$V_{IC} = V_{DD}/2$, $I_{OL} = -1\text{ mA}$	$V_{DD} = 3.3\text{ V}$		0.03	0.15	
		$T_A = -40^\circ C$ to $+105^\circ C$				0.22	
		$V_{IC} = V_{DD}/2$, $I_{OL} = -1\text{ mA}$	$V_{DD} = 5\text{ V}$		0.03	0.1	
		$T_A = -40^\circ C$ to $+105^\circ C$				0.15	
		$V_{IC} = V_{DD}/2$, $I_{OL} = -1\text{ mA}$	$V_{DD} = \pm 5\text{ V}$		0.05	0.08	
		$T_A = -40^\circ C$ to $+105^\circ C$				0.1	
		$V_{IC} = V_{DD}/2$, $I_{OL} = -5\text{ mA}$	$V_{DD} = 2.7\text{ V}$		0.5	0.7	V
		$T_A = -40^\circ C$ to $+105^\circ C$				1.1	
		$V_{IC} = V_{DD}/2$, $I_{OL} = -5\text{ mA}$	$V_{DD} = 3.3\text{ V}$		0.13	0.7	
		$T_A = -40^\circ C$ to $+105^\circ C$				1.1	
		$V_{IC} = V_{DD}/2$, $I_{OL} = -5\text{ mA}$	$V_{DD} = 5\text{ V}$		0.13	0.4	
		$T_A = -40^\circ C$ to $+105^\circ C$				0.5	
		$V_{IC} = V_{DD}/2$, $I_{OL} = -5\text{ mA}$	$V_{DD} = \pm 5\text{ V}$		0.16	0.3	
		$T_A = -40^\circ C$ to $+105^\circ C$				0.35	

3. $V_{DD} = \pm 5\text{ V}$ is shorthand for $V_{DD} = +5\text{ V}$ and $V_{EE} = -5\text{ V}$.

TLV271

DC ELECTRICAL CHARACTERISTICS ($V_{DD} = 2.7V, 3.3V, 5V$ & $\pm 5V$ (Note 3), $T_A = 25^\circ C$, $R_L \geq 10 k\Omega$ unless otherwise noted)

Parameter	Symbol	Conditions	Min	Typ	Max	Unit	
Output Current	I_O	$V_O = 0.5 V$ from rail, $V_{DD} = 2.7 V$	Positive rail		4.0		mA
			Negative rail		5.0		
		$V_O = 0.5 V$ from rail, $V_{DD} = 5 V$	Positive rail		7.0		
			Negative rail		8.0		
		$V_O = 0.5 V$ from rail, $V_{DD} = 10 V$	Positive rail		13		
			Negative rail		12		
Power Supply Quiescent Current	I_{DD}	$V_O = V_{DD}/2$	$V_{DD} = 2.7 V$		380	560	μA
			$V_{DD} = 3.3 V$		385	620	
			$V_{DD} = 5 V$		390	660	
			$V_{DD} = 10 V$		400	800	
		$T_A = -40^\circ C$ to $+105^\circ C$			1000		

3. $V_{DD} = \pm 5 V$ is shorthand for $V_{DD} = +5 V$ and $V_{EE} = -5 V$.

AC ELECTRICAL CHARACTERISTICS ($V_{DD} = 2.7 V, 5 V,$ & $\pm 5 V$ (Note 4), $T_A = 25^\circ C$, and $R_L \geq 10 k\Omega$ unless otherwise noted)

Parameter	Symbol	Conditions	Min	Typ	Max	Unit	
Unity Gain Bandwidth	UGBW	$R_L = 2 k\Omega, C_L = 10 pF$	$V_{DD} = 2.7 V$		3.2		MHz
			$V_{DD} = 5 V$ to $10 V$		3.5		
Slew Rate at Unity Gain	SR	$V_{O(pp)} = V_{DD}/2, R_L = 10 k\Omega, C_L = 50 pF$	$V_{DD} = 2.7 V$		1.35	2.1	$V/\mu S$
				$T_A = -40^\circ C$ to $+105^\circ C$		1	
		$V_{O(pp)} = V_{DD}/2, R_L = 10 k\Omega, C_L = 50 pF$	$V_{DD} = 5 V$		1.45	2.3	
				$T_A = -40^\circ C$ to $+105^\circ C$		1.2	
		$V_{O(pp)} = V_{DD}/2, R_L = 10 k\Omega, C_L = 50 pF$	$V_{DD} = \pm 5 V$		1.8	2.6	
$T_A = -40^\circ C$ to $+105^\circ C$				1.3			
Phase Margin	θ_m	$R_L = 2 k\Omega, C_L = 10 pF$		45		$^\circ$	
Gain Margin		$R_L = 2 k\Omega, C_L = 10 pF$		14		dB	
Settling Time to 0.1%	t_S	V -step(pp) = 1 V, AV = -1, $R_L = 2 k\Omega, C_L = 10 pF$	$V_{DD} = 2.7 V$		2.9		μS
			$V_{DD} = 5 V, \pm 5 V$		2.0		
Total Harmonic Distortion plus Noise	THD+N	$V_{DD} = 2.7 V, V_{O(pp)} = V_{DD}/2, R_L = 2 k\Omega, f = 10 kHz$	AV = 1		0.004		%
			AV = 10		0.04		
			AV = 100		0.3		
		$V_{DD} = 5 V, \pm 5 V, V_{O(pp)} = V_{DD}/2, R_L = 2 k\Omega, f = 10 kHz$	AV = 1		0.004		
			AV = 10		0.04		
Input-Referred Voltage Noise	e_n	f = 1 kHz		30		nV/\sqrt{Hz}	
		f = 10 kHz		20			
Input-Referred Current Noise	i_n	f = 1 kHz		0.6		fA/\sqrt{Hz}	

4. $V_{DD} = \pm 5 V$ is shorthand for $V_{DD} = +5 V$ and $V_{EE} = -5 V$.

TLV271

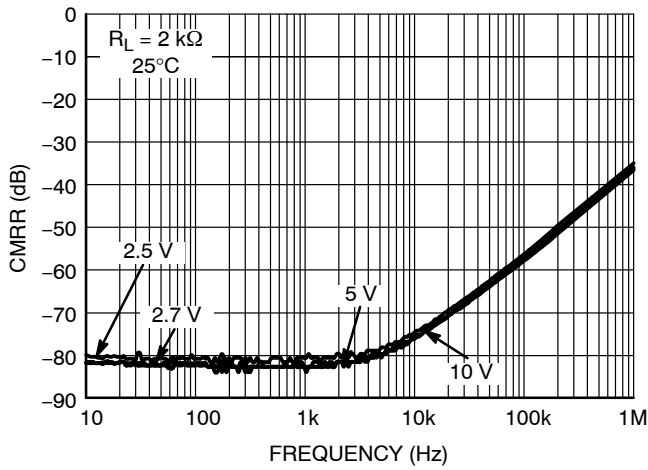

Figure 1. CMRR vs. Frequency

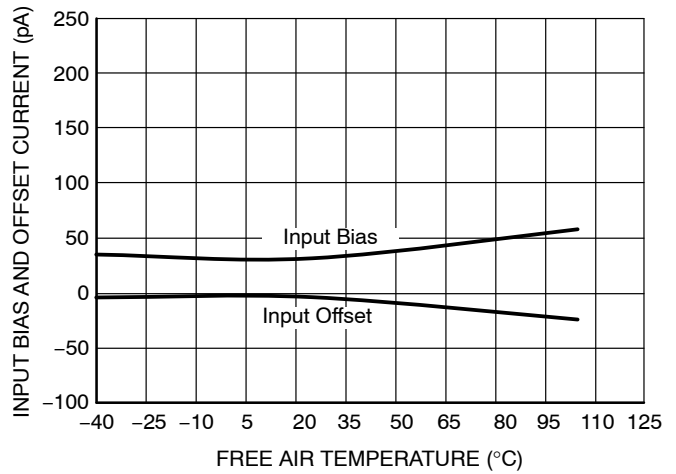

Figure 2. Input Bias and Offset Current vs. Temperature

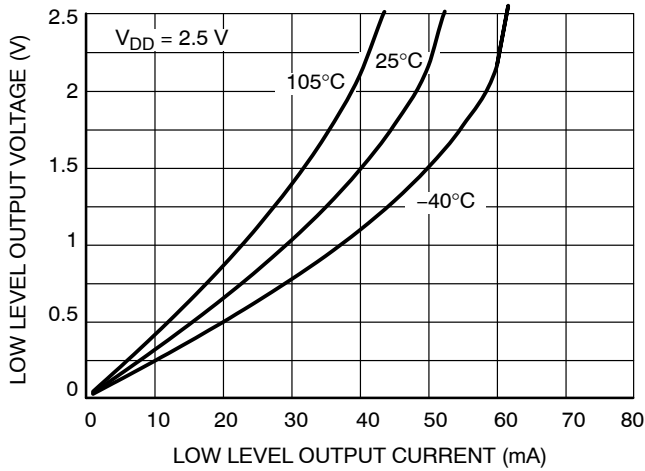

Figure 3. 2.5 V V_{OL} vs. I_{out}

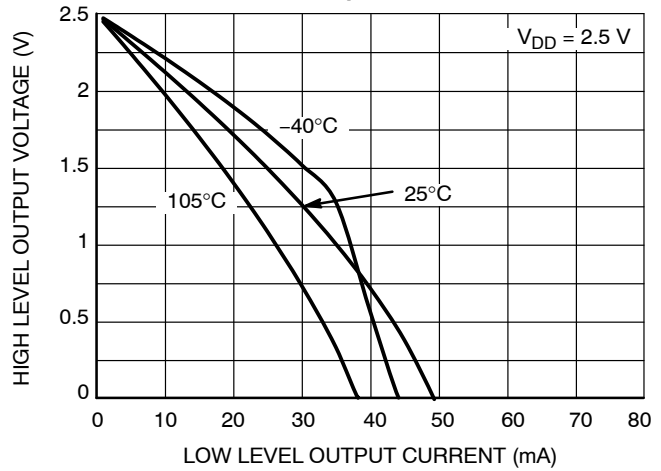

Figure 4. 2.5 V V_{OH} vs. I_{out}

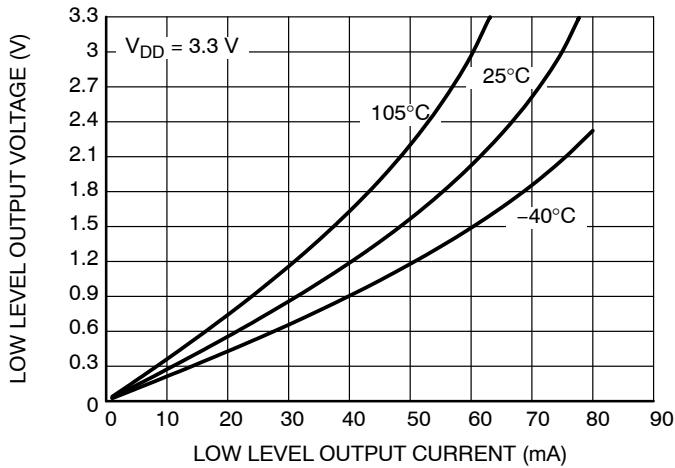

Figure 5. 3.3 V V_{OL} vs. I_{out}

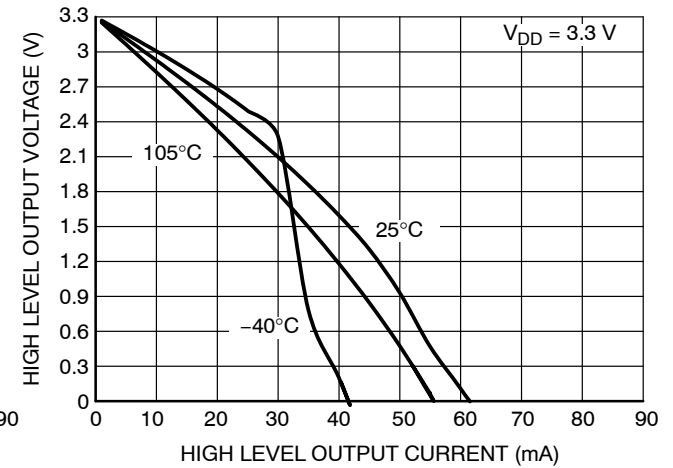

Figure 6. 3.3 V V_{OH} vs. I_{out}

TLV271

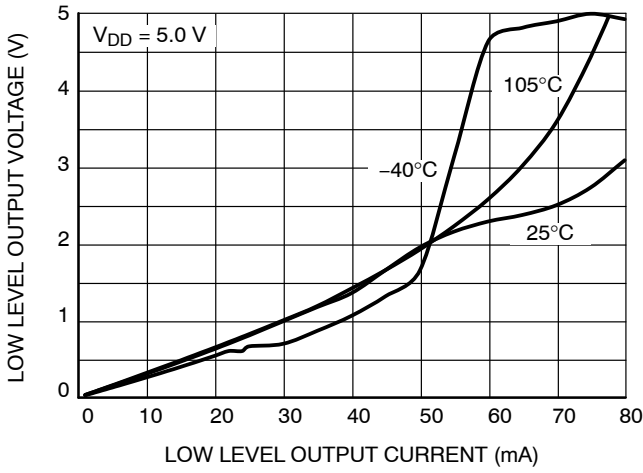

Figure 7. V_{OL} vs. I_{out}

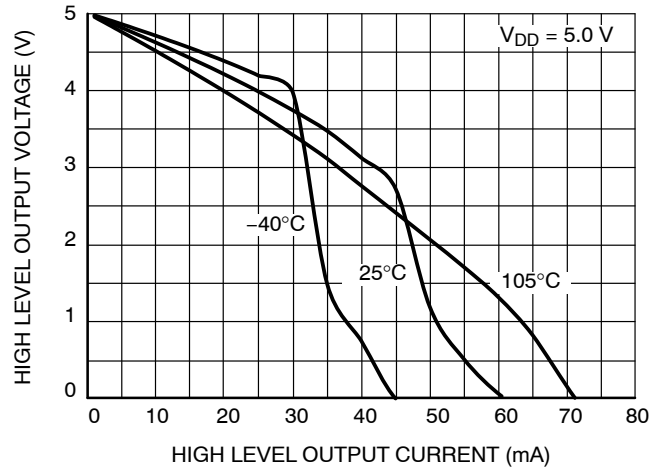

Figure 8. V_{OH} vs. I_{out}

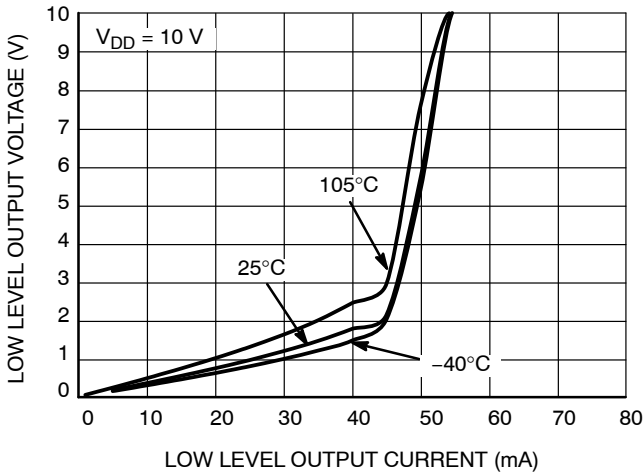

Figure 9. 10 V V_{OL} vs. I_{out}

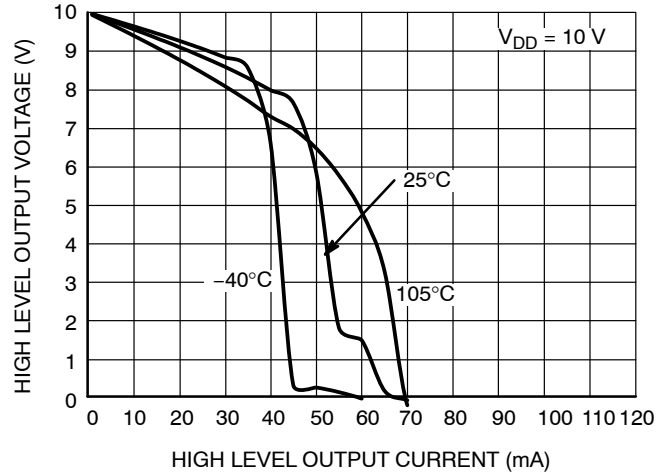

Figure 10. 10 V V_{OH} vs. I_{out}

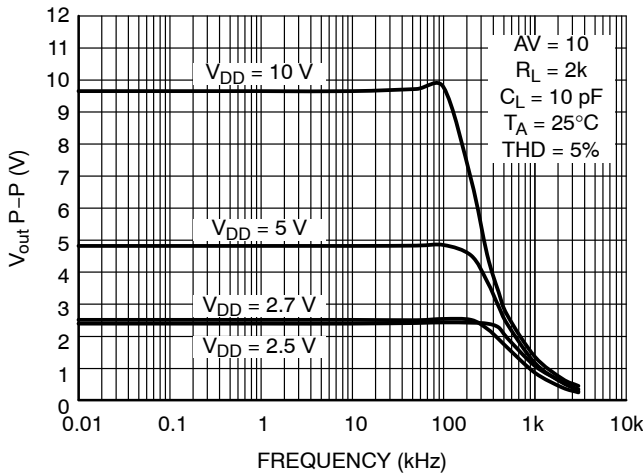

Figure 11. Peak-to-Peak Output vs. Supply vs. Frequency

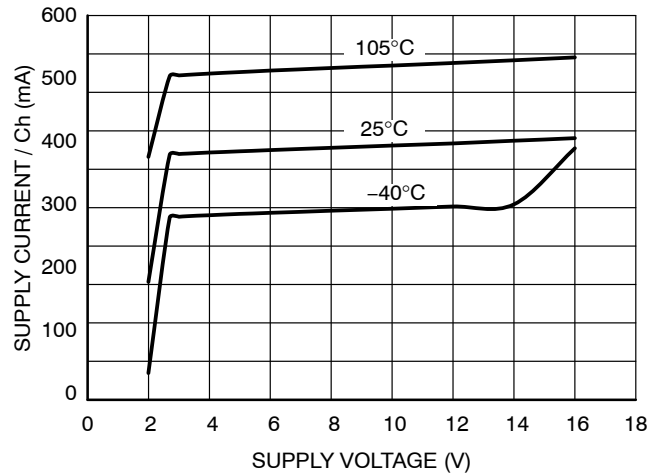

Figure 12. Supply Current vs. Supply Voltage

TLV271

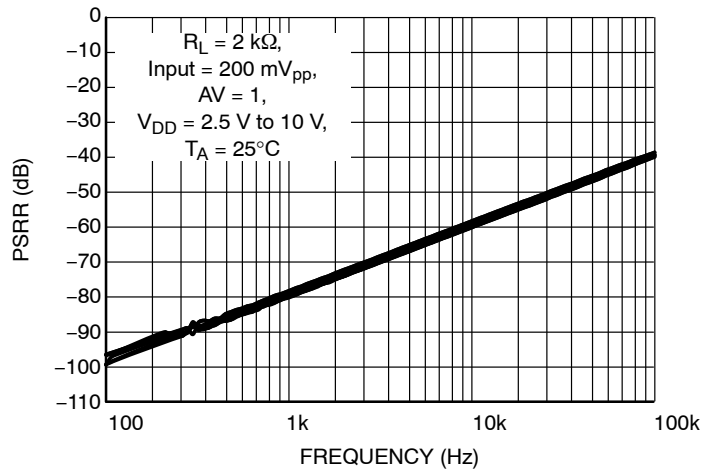

Figure 13. PSRR vs. Frequency

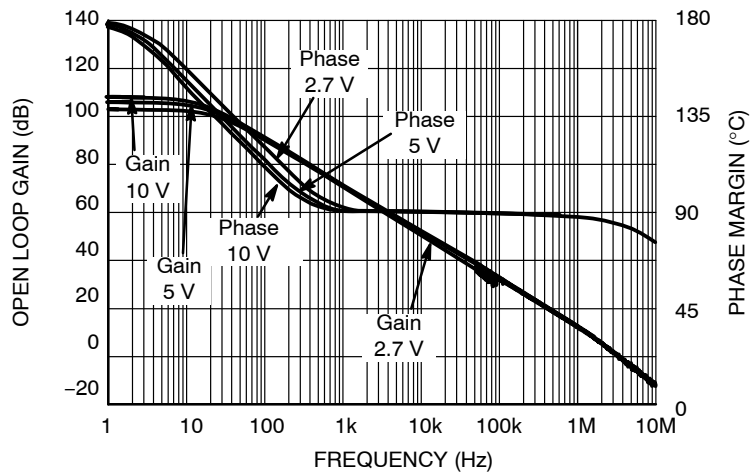

Figure 14. Open Loop Gain and Phase vs. Frequency

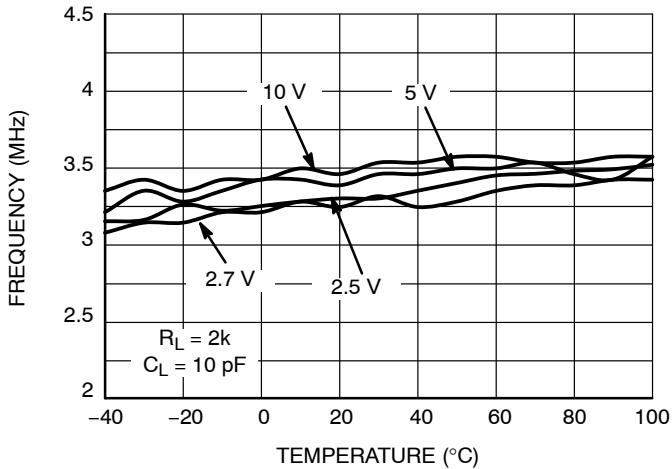

Figure 15. Gain Bandwidth Product vs. Temperature

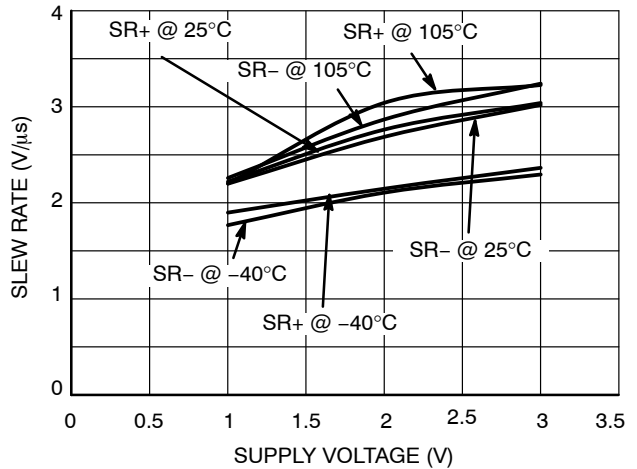

Figure 16. Slew Rate vs. Supply Voltage

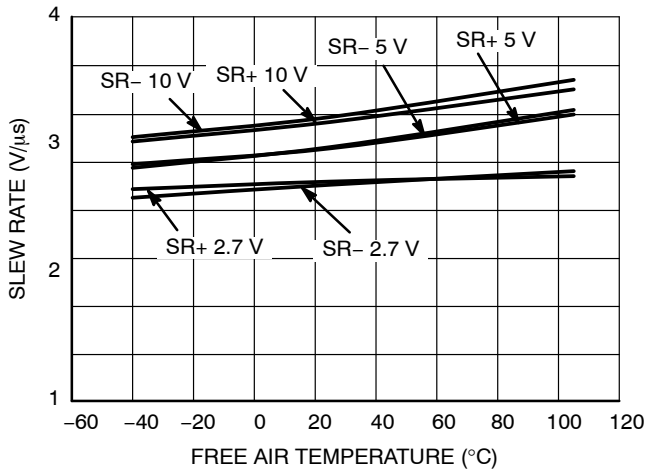

Figure 17. Slew Rate vs. Temperature

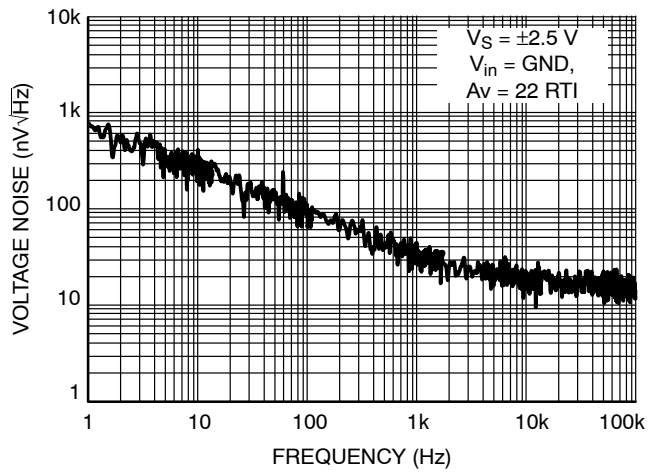

Figure 18. Voltage Noise vs. Frequency

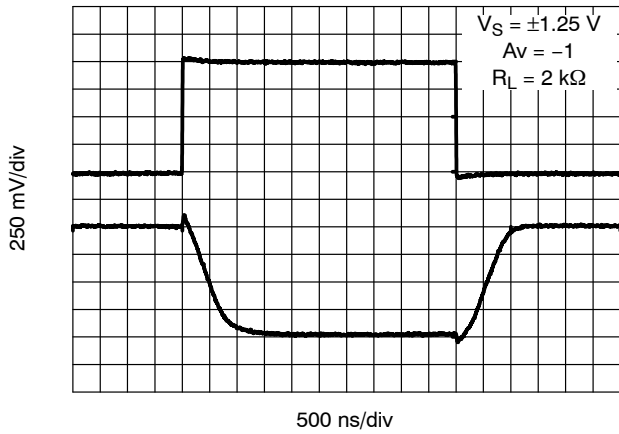

Figure 19. 2.5 V Inverting Large Signal Pulse Response

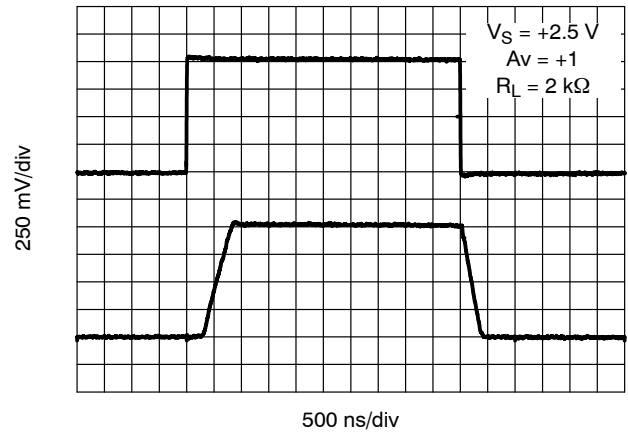

Figure 20. 2.5 V Non-Inverting Large Signal Pulse Response

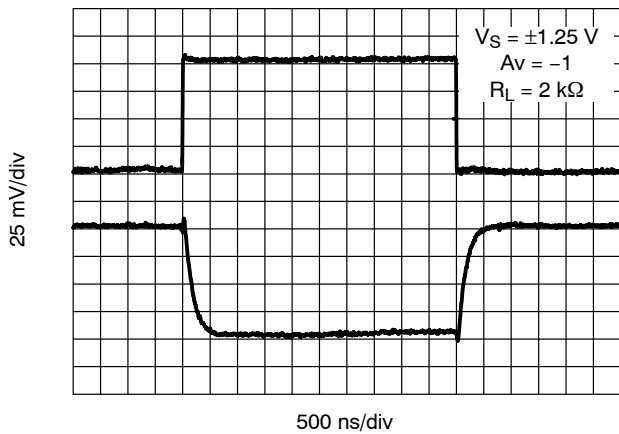

Figure 21. 2.5 V Inverting Small Signal Pulse Response

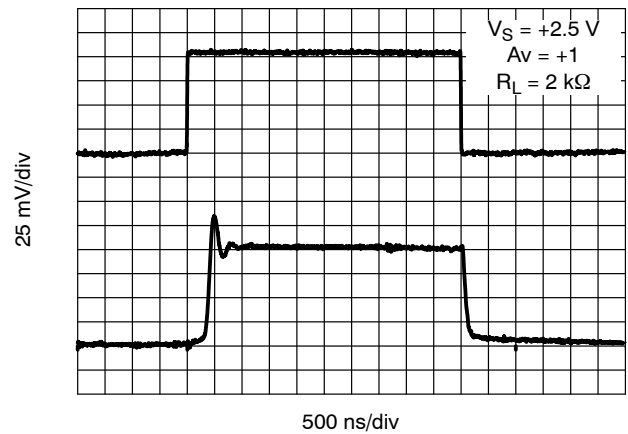
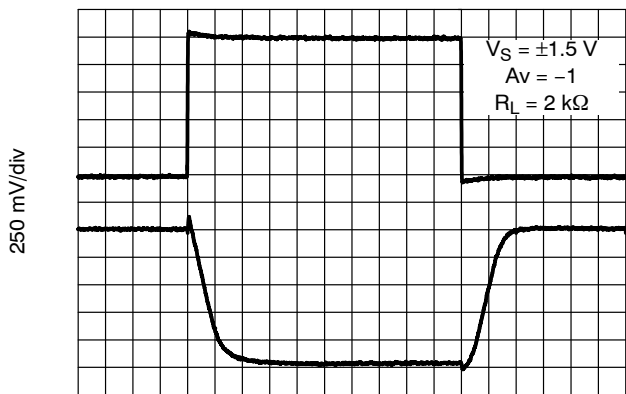

Figure 22. 2.5 V Non-Inverting Small Signal Pulse Response



500 ns/div

Figure 23. 3 V Inverting Large Signal Pulse Response



500 ns/div

Figure 24. 3 V Non-Inverting Large Signal Pulse Response

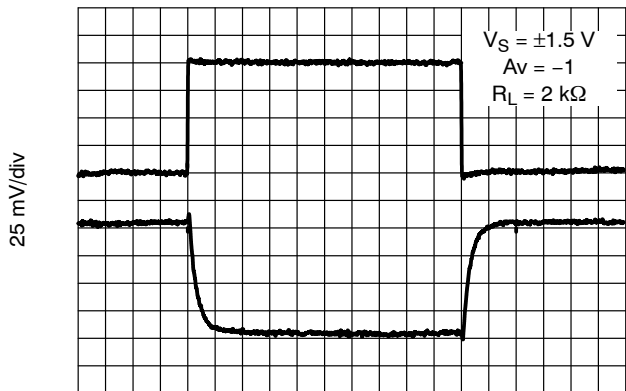

500 ns/div

Figure 25. 3 V Inverting Small Signal Pulse Response

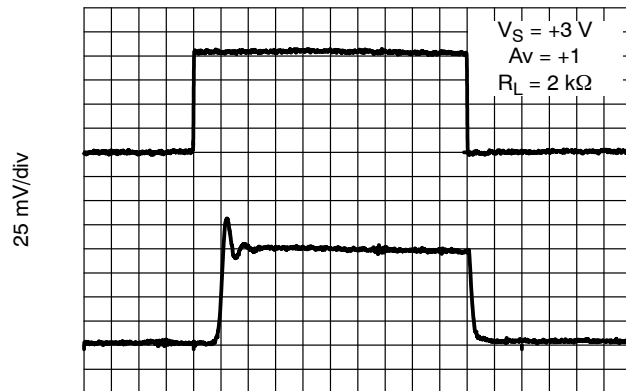

500 ns/div

Figure 26. 3 V Non-Inverting Small Signal Pulse Response

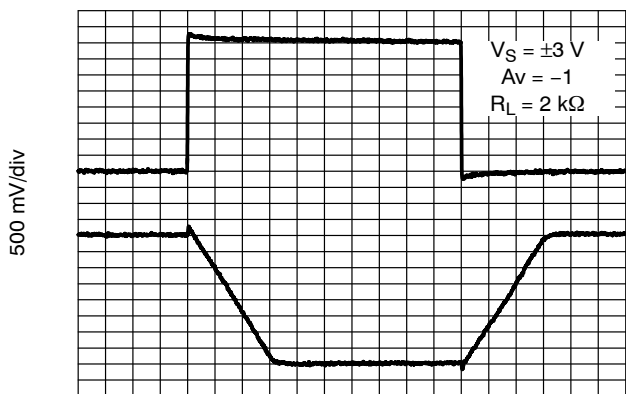

500 ns/div

Figure 27. 6 V Inverting Large Signal Pulse Response

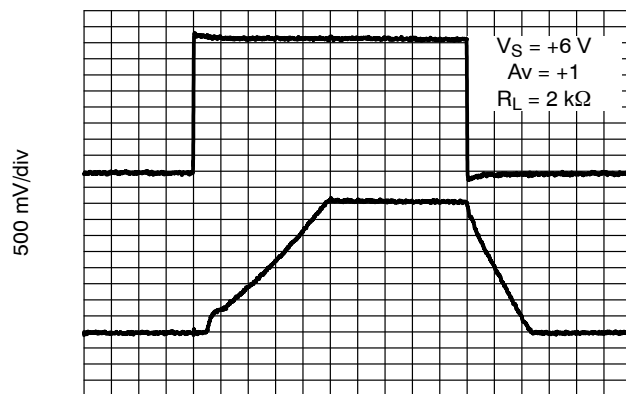

500 ns/div

Figure 28. 6 V Non-Inverting Large Signal Pulse Response

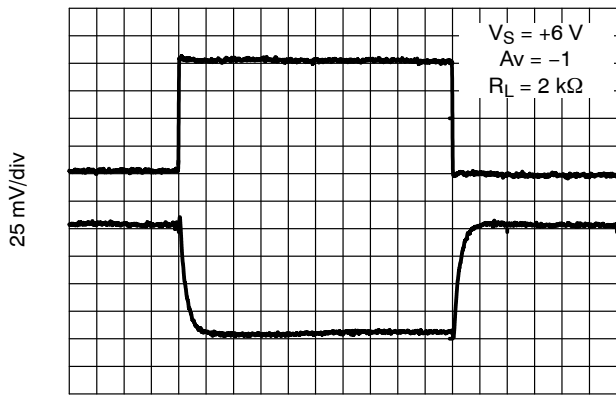

Figure 29. 6 V Inverting Small Signal Pulse Response

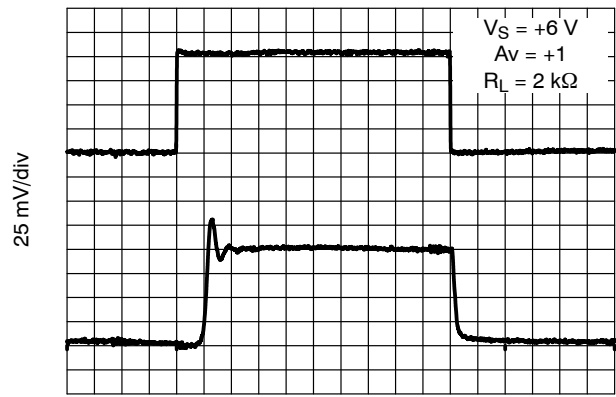

Figure 30. 6 V Non-Inverting Small Signal Pulse Response

TLV271

APPLICATIONS

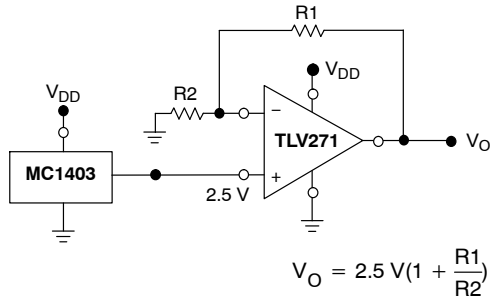

Figure 31. Voltage Reference

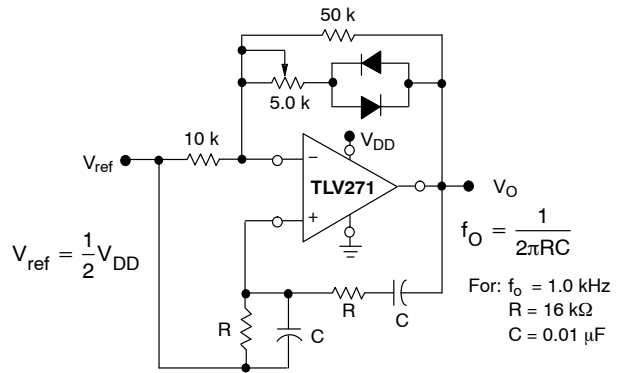

Figure 32. Wien Bridge Oscillator

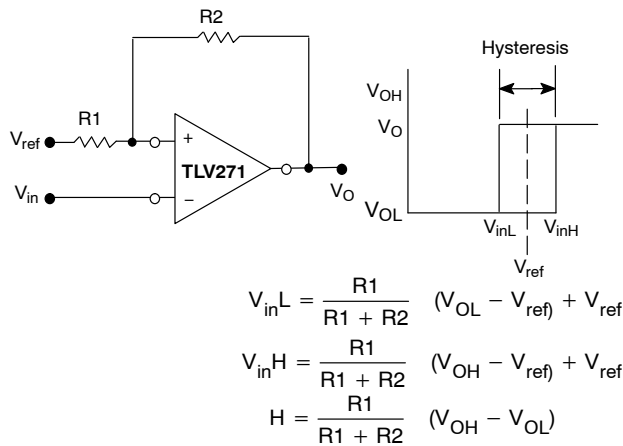
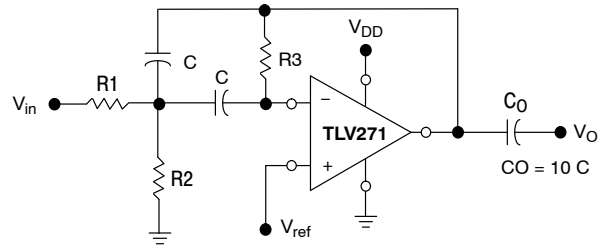

Figure 33. Comparator with Hysteresis



Given: f_o = center frequency
 $A(f_o)$ = gain at center frequency

Choose value f_o, C

$$\text{Then : } R3 = \frac{Q}{\pi f_o C}$$

$$R1 = \frac{R3}{2 A(f_o)}$$

$$R2 = \frac{R1 R3}{4Q^2 R1 - R3}$$

For less than 10% error from operational amplifier,
 $((Q_o f_o)/BW) < 0.1$ where f_o and BW are expressed in Hz.
 If source impedance varies, filter may be preceded with
 voltage follower buffer to stabilize filter parameters.

Figure 34. Multiple Feedback Bandpass Filter

TLV271

PACKAGE DIMENSIONS

TSOP-5 CASE 483-02 ISSUE K

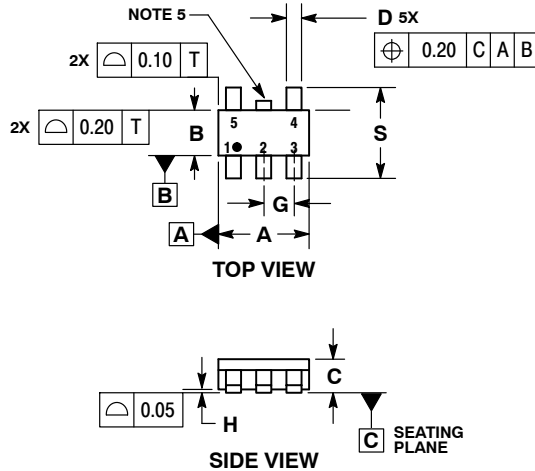

NOTES:

1. DIMENSIONING AND TOLERANCING PER ASME Y14.5M, 1994.
2. CONTROLLING DIMENSION: MILLIMETERS.
3. MAXIMUM LEAD THICKNESS INCLUDES LEAD FINISH THICKNESS. MINIMUM LEAD THICKNESS IS THE MINIMUM THICKNESS OF BASE MATERIAL.
4. DIMENSIONS A AND B DO NOT INCLUDE MOLD FLASH, PROTRUSIONS, OR GATE BURRS. MOLD FLASH, PROTRUSIONS, OR GATE BURRS SHALL NOT EXCEED 0.15 PER SIDE. DIMENSION A.
5. OPTIONAL CONSTRUCTION: AN ADDITIONAL TRIMMED LEAD IS ALLOWED IN THIS LOCATION. TRIMMED LEAD NOT TO EXTEND MORE THAN 0.2 FROM BODY.

DIM	MILLIMETERS	
	MIN	MAX
A	3.00 BSC	
B	1.50 BSC	
C	0.90	1.10
D	0.25	0.50
G	0.95 BSC	
H	0.01	0.10
J	0.10	0.26
K	0.20	0.60
M	0°	10°
S	2.50	3.00

SOLDERING FOOTPRINT*

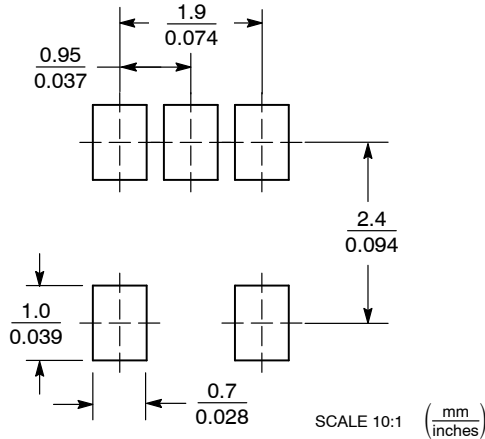

*For additional information on our Pb-Free strategy and soldering details, please download the ON Semiconductor Soldering and Mounting Techniques Reference Manual, SOLDERRM/D.

ON Semiconductor and are registered trademarks of Semiconductor Components Industries, LLC (SCILLC). SCILLC reserves the right to make changes without further notice to any products herein. SCILLC makes no warranty, representation or guarantee regarding the suitability of its products for any particular purpose, nor does SCILLC assume any liability arising out of the application or use of any product or circuit, and specifically disclaims any and all liability, including without limitation special, consequential or incidental damages. "Typical" parameters which may be provided in SCILLC data sheets and/or specifications can and do vary in different applications and actual performance may vary over time. All operating parameters, including "Typicals" must be validated for each customer application by customer's technical experts. SCILLC does not convey any license under its patent rights nor the rights of others. SCILLC products are not designed, intended, or authorized for use as components in systems intended for surgical implant into the body, or other applications intended to support or sustain life, or for any other application in which the failure of the SCILLC product could create a situation where personal injury or death may occur. Should Buyer purchase or use SCILLC products for any such unintended or unauthorized application, Buyer shall indemnify and hold SCILLC and its officers, employees, subsidiaries, affiliates, and distributors harmless against all claims, costs, damages, and expenses, and reasonable attorney fees arising out of, directly or indirectly, any claim of personal injury or death associated with such unintended or unauthorized use, even if such claim alleges that SCILLC was negligent regarding the design or manufacture of the part. SCILLC is an Equal Opportunity/Affirmative Action Employer. This literature is subject to all applicable copyright laws and is not for resale in any manner.

PUBLICATION ORDERING INFORMATION

LITERATURE FULFILLMENT:
Literature Distribution Center for ON Semiconductor
P.O. Box 5163, Denver, Colorado 80217 USA
Phone: 303-675-2175 or 800-344-3860 Toll Free USA/Canada
Fax: 303-675-2176 or 800-344-3867 Toll Free USA/Canada
Email: orderlit@onsemi.com

N. American Technical Support: 800-282-9855 Toll Free
USA/Canada
Europe, Middle East and Africa Technical Support:
Phone: 421 33 790 2910
Japan Customer Focus Center
Phone: 81-3-5817-1050

ON Semiconductor Website: www.onsemi.com

Order Literature: <http://www.onsemi.com/orderlit>

For additional information, please contact your local Sales Representative