

**High Gain Single and Dual Operational Amplifiers
for Military, Industrial and Commercial Applications**

March 1993

Features

- Input Bias Current (All Types) 500nA (Max.)
- Input Offset Current (All Types) 200nA (Max.)

Applications

- Comparator
- DC Amplifier
- Integrator or Differentiator
- Multivibrator
- Summing Amplifier
- Narrow Band or Band Pass Filter

Description

The CA1458, CA1558 (dual types); CA741C, CA741 (single types); high-gain operational amplifiers for use in military, industrial, and commercial applications.

These monolithic silicon integrated circuit devices provide output short circuit protection and latch-free operation. These types also feature wide common mode and differential mode signal ranges and have low offset voltage nulling capability when used with an appropriately valued potentiometer. A 10kΩ potentiometer is used for offset nulling types CA741C, CA741 (See Figure 4); and types CA1458, CA1558, have no specific terminals for offset nulling. Each type consists of a differential input amplifier that effectively drives a gain and level shifting stage having a complementary emitter follower output.

The manufacturing process make it possible to produce IC operational amplifiers with low burst ("popcorn") noise characteristics. The CA741 gives limit specifications for burst noise in the data bulletin, File Number 530. Contact your Sales Representative for information pertinent to other operational amplifier types that meet low burst noise specifications.

Ordering Information

PART NUMBER	TEMP. RANGE	PACKAGE
CA741E	-55°C to +125°C	8 Lead Plastic DIP
CA741CE	0°C to +70°C	8 Lead Plastic DIP
CA1458E	0°C to +70°C	8 Lead Plastic DIP
CA1558E	-55°C to +125°C	8 Lead Plastic DIP
CA741T	-55°C to +125°C	8 Pin Can
CA741CT	0°C to +70°C	8 Pin Can
CA1458T	0°C to +70°C	8 Pin Can
CA1558T	-55°C to +125°C	8 Pin Can

NOTE: All types in any package style can be operated over the temperature range of -55°C to +125°C, although the published limits for certain electrical specifications apply only over the temperature range of 0°C to +70°C.

Pinouts

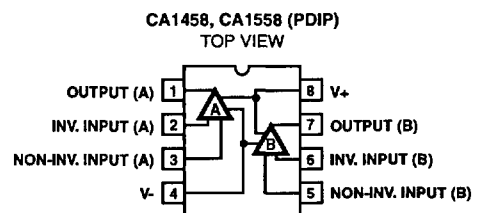
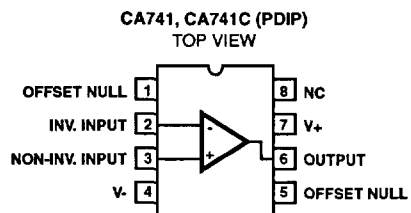
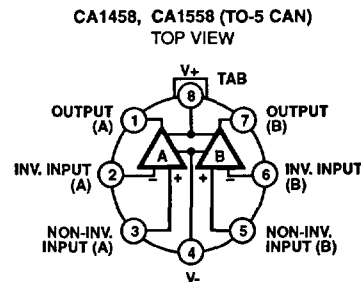
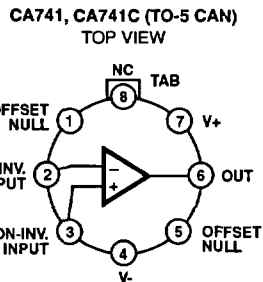

* Technical Data on LM Branded types is identical to the corresponding CA Branded types.
CAUTION: These devices are sensitive to electrostatic discharge. Users should follow proper I.C. Handling Procedures.
Copyright © Harris Corporation 1993

Specifications CA741, CA741C, CA1458, CA1558, LM741, LM741C, LM1458, LM1558

Absolute Maximum Ratings

Supply Voltage (Between V+ and V- Terminals)	
CA741C, CA1458 (Note 3)	36V
CA741, CA1558 (Note 3)	44V
Differential Input Voltage	30V
Input Voltage (Note 2)	±15V
Offset Terminal to V- Terminal Voltage (CA741C, CA741)	±0.5V
Output Short Circuit Duration	Indefinite
Power Dissipation	
Up to +70°C (CA741C)	500mW
Up to +75°C (CA741)	500mW
Up to +30°C (CA1558)	680mW
Up to +25°C (CA1458)	680mW
For Temperatures exceeding those indicated above	Derate Linearly 6.67mW/°C
Junction Temperature	+175°C
Junction Temperature (Plastic Package)	+150°C
Lead Temperature (Soldering 10 Sec.)	+300°C

Operating Conditions

Storage Temperature Range	-65°C to +150°C
Operating Temperature Range	
CA741, CA1558	-55°C to +125°C
CA741C, CA1458	0°C to +70°C (Note 4)

CAUTION: Stresses above those listed in "Absolute Maximum Ratings" may cause permanent damage to the device. This is a stress only rating and operation of the device at these or any other conditions above those indicated in the operational sections of this specification is not implied.

Electrical Specifications Typical Values Intended Only for Design Guidance, $V_{\pm} = \pm 15V$

PARAMETERS	SYMBOL	TEST CONDITIONS	TYPICAL VALUE (ALL TYPES)	UNITS
Input Capacitance	C_i		1.4	pF
Offset Voltage Adjustment Range			±15	mV
Output Resistance	R_o		75	Ω
Output Short Circuit Current			25	mA
Transient Response		Unity Gain, $V_i = 20mV$, $R_L = 2k\Omega$, $C_L \leq 100pF$		
Rise Time	t_R		0.3	μs
Overshoot	O.S.		5.0	%
Slew Rate (Closed Loop)	SR	$R_L \geq 2k\Omega$	0.5	V/ μs

Electrical Specifications For Equipment Design, $V_{\pm} = \pm 15V$

PARAMETERS	SYMBOL	TEST CONDITIONS	TEMPERATURE	LIMITS			UNITS
				CA741C, CA1458 (NOTE 1)			
				MIN	TYP	MAX	
Input Offset Voltage	V_{io}	$R_S \leq 10k\Omega$	+25°C	-	2	6	mV
			0°C to +70°C	-	-	7.5	mV
Input Offset Current	i_{io}		+25°C	-	20	200	nA
			0°C to +70°C	-	-	300	nA
Input Bias Current	i_{ib}		+25°C	-	80	500	nA
			0°C to +70°C	-	-	800	nA
Input Resistance	R_i			0.3	2	-	M Ω
Open Loop Differential Voltage Gain	A_{OL}	$R_L \geq 2k\Omega$, $V_O = \pm 10V$	+25°C	20,000	200,000	-	V/V
			0°C to +70°C	15,000	-	-	V/V
Common Mode Input Voltage Range	V_{ICR}		+25°C	±12	±13	-	V
Common Mode Rejection Ratio	CMRR	$R_S \leq 10k\Omega$	+25°C	70	90	-	dB
Supply Voltage Rejection Ratio	PSRR	$R_S \leq 10k\Omega$	+25°C	-	30	150	$\mu V/V$

Specifications CA741C, CA741, CA1458, CA1558, LM741, LM741C, LM1458, LM1558

Electrical Specifications For Equipment Design, $V_{\pm} = \pm 15V$ (Continued)

PARAMETERS	SYMBOL	TEST CONDITIONS	TEMPERATURE	LIMITS			UNITS
				CA741C, CA1458 (NOTE 1)			
				MIN	TYP	MAX	
Output Voltage Swing	V_{OPP}	$R_L \geq 10k\Omega$	+25°C	±12	±14	-	V
			+25°C	±10	±13	-	V
				0°C to +70°C	±10	±13	-
Supply Current	I_{\pm}		+25°C	-	1.7	2.8	mA
Device Dissipation	P_D		+25°C	-	50	85	mW

NOTE: 1. Values Apply for Each Section of the Dual Amplifiers

Electrical Specifications For Equipment Design, $V_{\pm} = \pm 15V$

PARAMETERS	SYMBOL	TEST CONDITIONS	TEMPERATURE	LIMITS			UNITS
				CA741, CA1558 (NOTE 1)			
				MIN	TYP	MAX	
Input Offset Voltage	V_{IO}	$R_S \leq 10k\Omega$	+25°C	-	1	5	mV
			-55°C to +125°C	-	1	6	mV
Input Offset Current	I_{IO}		+25°C	-	20	200	nA
			-55°C	-	85	500	nA
			+125°C	-	7	200	nA
Input Bias Current	I_{IB}		+25°C	-	80	500	nA
			-55°C	-	300	1500	nA
			+125°C	-	30	500	nA
Input Resistance	R_I		-	0.3	2	-	MΩ
Open Loop Differential Voltage Gain	A_{OL}	$R_L \geq 2k\Omega$, $V_O = \pm 10V$	+25°C	50,000	200,000	-	V/V
			-55°C to +125°C	25,000	-	-	V/V
Common Mode Input Voltage Range	V_{ICR}		-55°C to +125°C	±12	±13	-	V
Common Mode Rejection Ratio	CMRR	$R_S \leq 10k\Omega$	-55°C to +125°C	70	90	-	dB
Supply Voltage Rejection Ratio	PSRR	$R_S \leq 10k\Omega$	-55°C to +125°C	-	30	150	μV/V
Output Voltage Swing	V_{OPP}	$R_L \geq 10k\Omega$	-55°C to +125°C	±12	±14	-	V
			$R_L \geq 2k\Omega$	-55°C to +125°C	±10	±13	-
Supply Current	I_{\pm}		+25°C	-	1.7	2.8	mA
			-55°C	-	2	3.3	mA
			+125°C	-	1.5	2.5	mA
Device Dissipation	P_D		+25°C	-	50	85	mW
			-55°C	-	60	100	mW
			+125°C	-	45	75	mW

NOTES:

1. Values Apply for Each Section of the Dual Amplifiers
2. If supply voltage is less than $\pm 15V$, the Absolute Maximum Input Voltage is equal to the Supply Voltage
3. Voltage values apply for each of the dual operational amplifiers
4. All types in any package style can be operated over the temperature range of -55°C to +125°C, although the published limits for certain electrical specification apply only over the temperature range of 0°C to +70°C

CA741C, CA741, CA1458, CA1558, LM741, LM741C, LM1458, LM1558

Schematic Diagram

CA741C, CA741 AND FOR EACH AMPLIFIER OF THE CA1458 AND CA1558

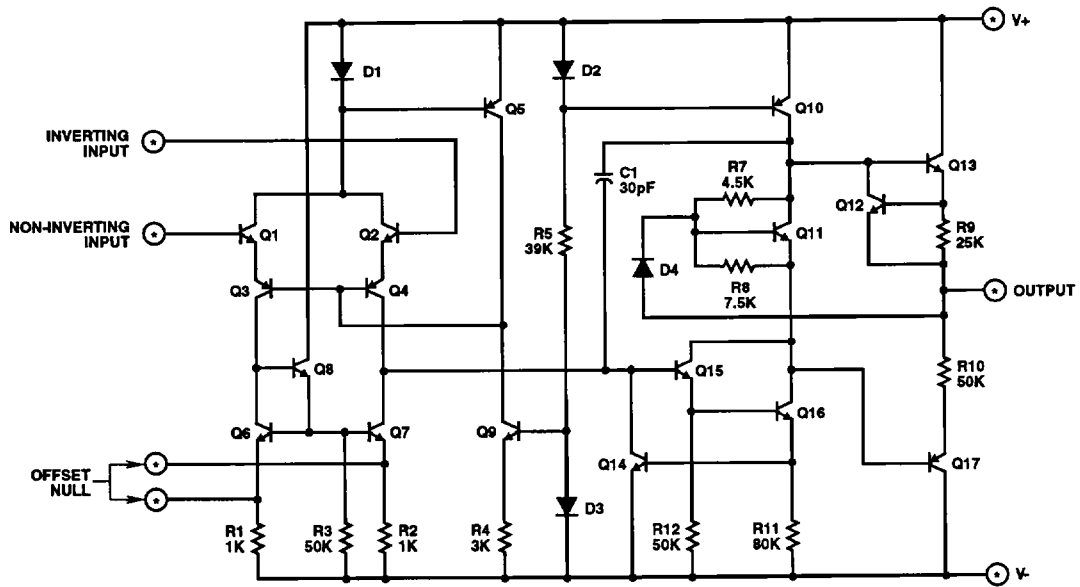

* See Functional Diagram for Terminal Numbers of Respective Type Numbers.

NOTE: All Resistance Values are in Ω

Typical Performance Curves

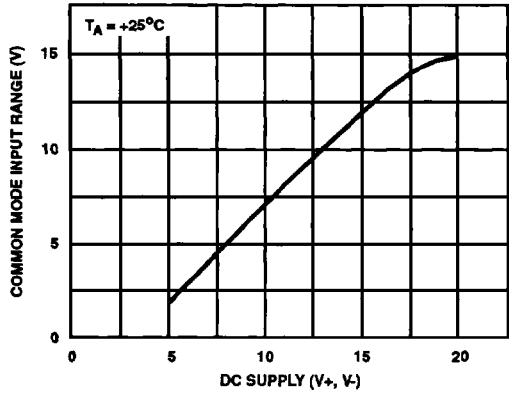

FIGURE 1. COMMON MODE INPUT VOLTAGE RANGE vs SUPPLY VOLTAGE FOR ALL TYPES

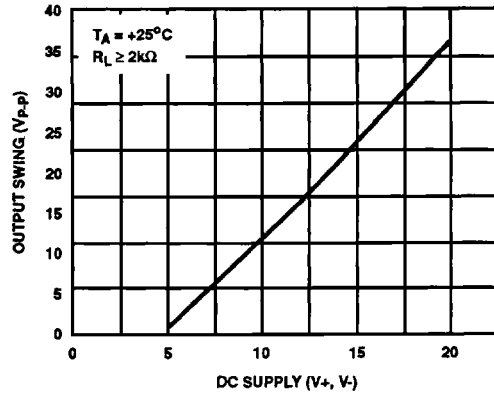

FIGURE 2. OUTPUT VOLTAGE vs SUPPLY VOLTAGE FOR ALL TYPES

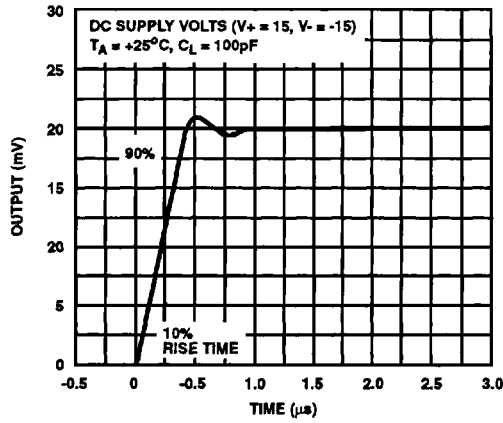

FIGURE 3. OUTPUT VOLTAGE vs TRANSIENT RESPONSE TIME FOR CA741C AND CA741

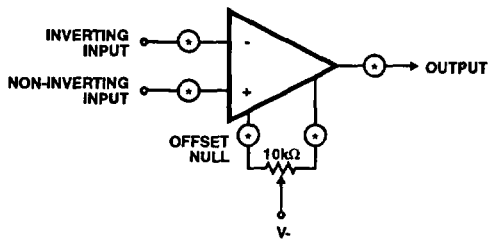

FIGURE 4. OFFSET VOLTAGE NULL CIRCUIT FOR CA741C AND CA741

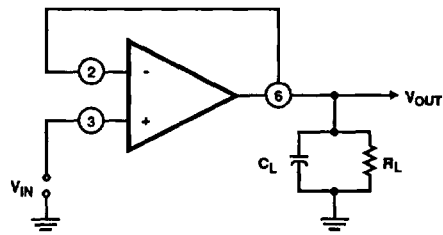
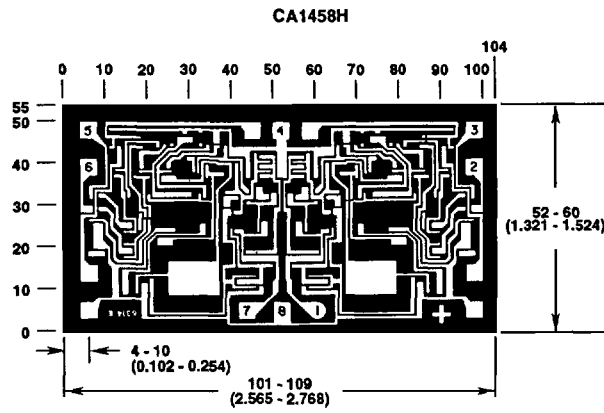
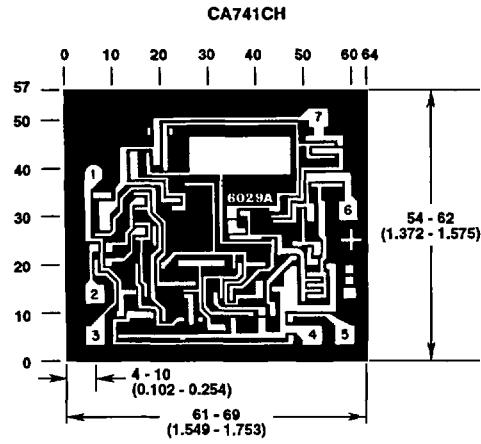

FIGURE 5. TRANSIENT RESPONSE TEST CIRCUIT FOR ALL TYPES

Metallization Mask Layout



NOTE: Dimensions in parentheses are in millimeters and are derived from the basic inch dimensions as indicated. Grid graduations are in mils (10^{-3} inch)