

### FEATURES

- **Current Transfer Ratio**  
MCT5210, >70% at  $I_F=3.0$  mA  
MCT5211, >110% at  $I_F=1.0$  mA
- **Saturation CTR—MCT5211, >100% at  $I_F=1.6$  mA**
- **High Isolation Voltage, 5300 V<sub>RMS</sub>**
- **Underwriters Lab File #E52744**
- **VDE #0884 Available with Option 1**

### DESCRIPTION

The MCT5210/5211 are optocouplers with a high efficiency AlGaAs LED optically coupled to a NPN phototransistor. The high performance LED makes operation at low input currents practical. The coupler is housed in a double molded, six pin DIP package. Isolation test voltage is 5300 V<sub>RMS</sub>.

Because these parts have guaranteed CTRs at one and three mA, they are ideally suitable for interfacing from CMOS to TTL or LSTTL to TTL. They are also ideal for telecommunications applications such as ring or off-hook detection.

### Maximum Ratings

#### Emitter

Peak Reverse Voltage .....6.0 V  
Continuous Forward Current ..... 40 mA  
Power Dissipation at 25°C.....75 mW  
Derate Linearly from 25°C ..... 1.0 mW/°C

#### Detector

Collector-Emitter Breakdown Voltage.....30 V  
Emitter-Collector Breakdown Voltage.....7.0 V  
Collector-Base Breakdown Voltage.....70 V  
Power Dissipation.....200 mW  
Derate Linearly from 25°C ..... 2.6 mW/°C

#### Package

Isolation Test Voltage..... 5300 V<sub>RMS</sub>  
Total Package Dissipation  
at 25°C Ambient (LED + Detector) .....260 mW  
Derate Linearly from 25°C ..... 3.5 mW/°C  
Leakage Path ..... ≥7.0 mm  
Clearance Path..... ≥7.0 mm  
Comparative Tracking Index per  
DIN IEC 112/VDE 0303, part 1 ..... 175  
Isolation Resistance  
 $V_{IO}=500$  V,  $T_A=25^\circ\text{C}$  ..... ≥10<sup>12</sup> Ω  
 $V_{IO}=500$  V,  $T_A=100^\circ\text{C}$  ..... ≥10<sup>11</sup> Ω  
Operating Temperature ..... -55°C to +100°C  
Storage Temperature..... -55°C to +150°C

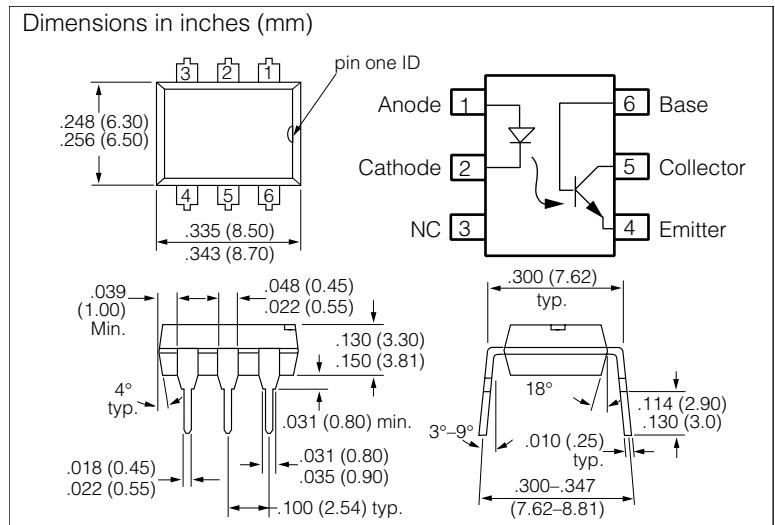

### Electrical Characteristics ( $T_A=25^\circ\text{C}$ )

Parameter	Symbol	Min.	Typ.	Max.	Unit	Condition
<b>Emitter</b>						
Forward Voltage	$V_F$	—	1.2	1.5	V	$I_F=5.0$ mA
Reverse Voltage	$V_R$	6.0	—	—	V	$I_R=10$ μA
<b>Detector</b>						
	$H_{FE}$	100	200	—	—	$V_{CE}=5.0$ V $I_C=100$ μA
	$BV_{CEO}$	30	—	—	V	$I_C=100$ μA
	$BV_{ECO}$	7.0	—	—	V	$I_E=100$ μA
	$BV_{CBO}$	70	—	—	V	$I_E=10$ μA
	$I_{CEO}$	—	5.0	100	nA	$V_{CE}=10$ V
<b>Package (0–70°C)</b>						
Saturated Current Transfer Ratio						$V_{CE}=0.4$ V
MCT5210	$CTR_{CEsat}$	60	120	—	%	$I_F=3.0$ mA
MCT5211	$CTR_{CEsat}$	100	200	—	%	$I_F=1.6$ mA
MCT5211	$CTR_{CEsat}$	75	150	—	%	$I_F=1.0$ mA
Current Transfer Ratio						$V_{CE}=5.0$ V
MCT5210	CTR	70	150	—	%	$I_F=3.0$ mA
MCT5211	CTR	150	300	—	%	$I_F=1.6$ mA
MCT5211	CTR	110	225	—	%	$I_F=1.0$ mA
Collector-Base Current Transfer Ratio						$V_{CE}=4.3$ V
MCT5210	$CTR_{CB}$	0.2	0.4	—	%	$I_F=3.0$ mA
MCT5211	$CTR_{CB}$	0.3	0.6	—	%	$I_F=1.6$ mA
MCT5211	$CTR_{CB}$	0.25	0.5	—	%	$I_F=1.0$ mA
<b>Saturation Voltage</b>						
MCT5210	$V_{CEsat}$	—	0.25	0.4	V	$I_F=3.0$ mA $I_C=1.8$ mA
MCT5211	$V_{CEsat}$	—	0.25	0.4	V	$I_F=1.6$ mA $I_C=1.6$ mA

Characteristics — continued

Parameter	Symbol	Min.	Typ.	Max.	Unit	Condition
<b>Switching Characteristics (25°C)</b>						
Propagation Delay —High to Low						
MCT5210	$t_{PHL}$		10		$\mu\text{s}$	$R_L=330\ \Omega, I_F=3.0\ \text{mA}, V_{CC}=5.0\ \text{V}$
MCT5211	$t_{PHL}$		20		$\mu\text{s}$	$R_L=750\ \Omega, I_F=1.6\ \text{mA}, V_{CC}=5.0\ \text{V}$
MCT5211	$t_{PHL}$		40		$\mu\text{s}$	$R_L=1.5\ \text{K}\Omega, I_F=1.0\ \text{mA}, V_{CC}=5.0\ \text{V}$
Propagation Delay —Low to High						
MCT5210	$t_{PHL}$		10		$\mu\text{s}$	$R_L=330\ \Omega, I_F=3.0\ \text{mA}, V_{CC}=5.0\ \text{V}$
MCT5211	$t_{PHL}$		20		$\mu\text{s}$	$R_L=750\ \Omega, I_F=1.6\ \text{mA}, V_{CC}=5.0\ \text{V}$
MCT5211	$t_{PHL}$		40		$\mu\text{s}$	$R_L=1.5\ \text{K}\Omega, I_F=1.0\ \text{mA}, V_{CC}=5.0\ \text{V}$

Figure 1. Forward current vs. forward voltage

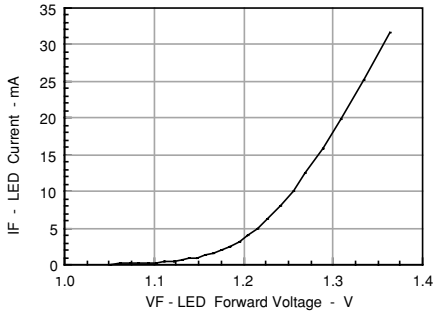

Figure 2. LED forward current vs. forward voltage

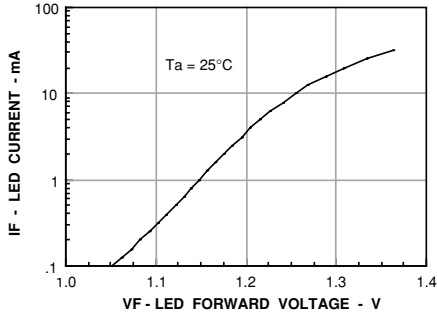

Figure 3. Switching waveform

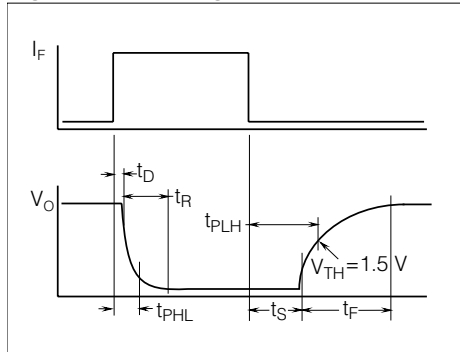

Figure 4. Collector base photocurrent vs. LED current

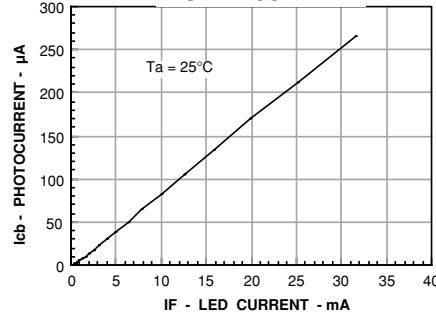

Figure 5. Photocurrent vs. LED current

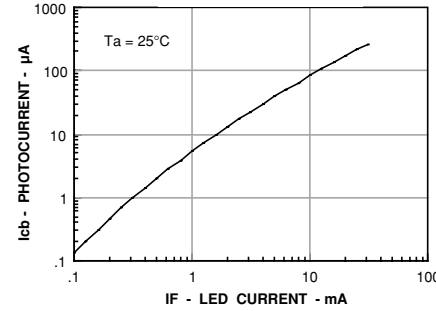

Figure 6. Switching schematic

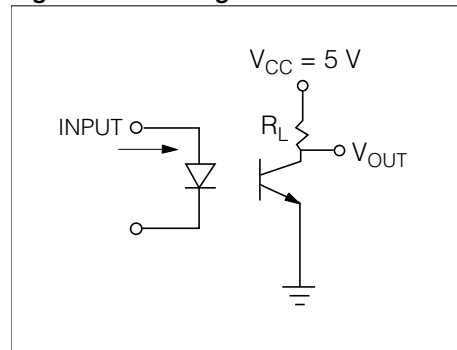

Figure 7. Collector base current transfer ratio vs. LED current

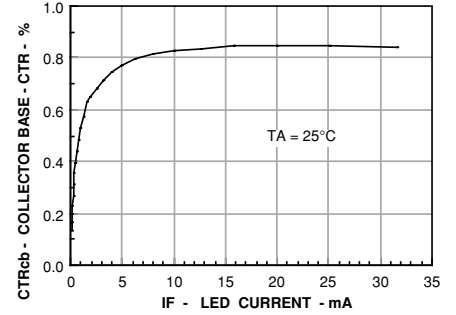

Figure 8. Collector base current transfer ratio vs. LED current

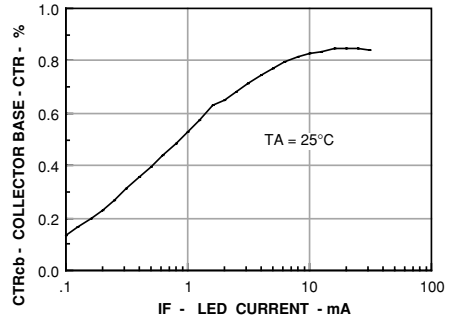

Figure 9. Current transfer ratio vs. LED current

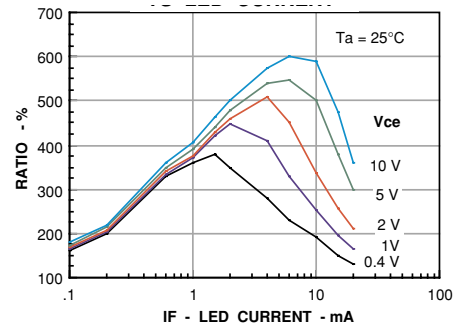

Figure 10. Collector current vs. LED current

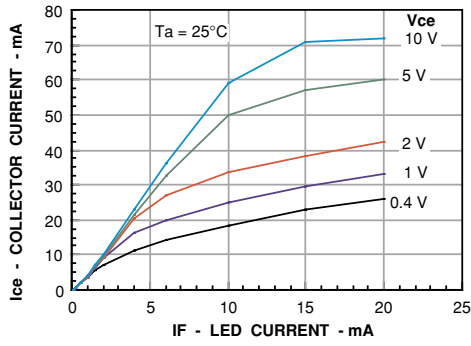

Figure 11. Collector current vs. LED current

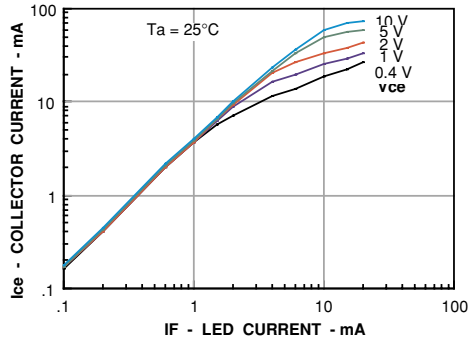

Figure 12. Transistor current gain vs. base current

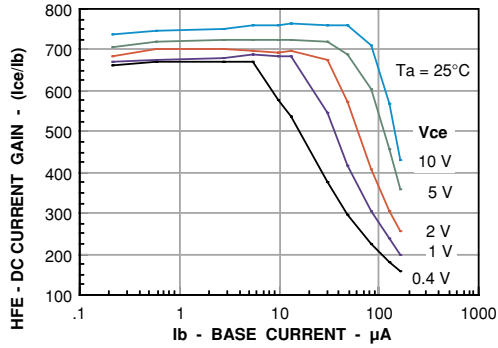

Figure 13. Transfer curve

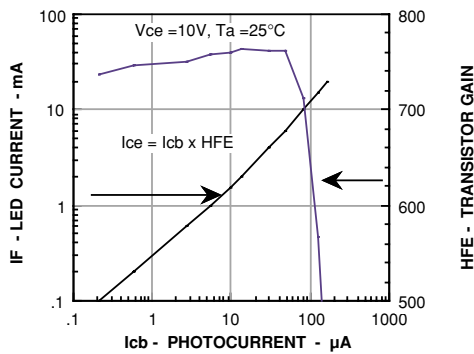

Figure 14. Transfer curve

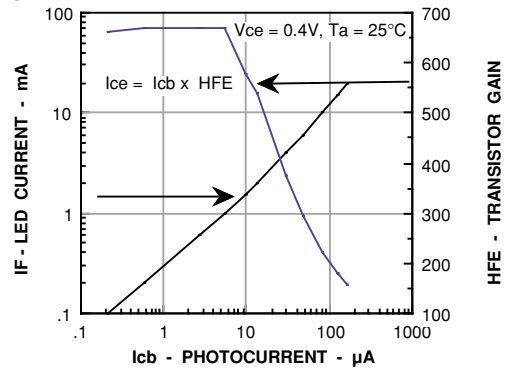

Figure 15. Propagation delay vs. base emitter resistor

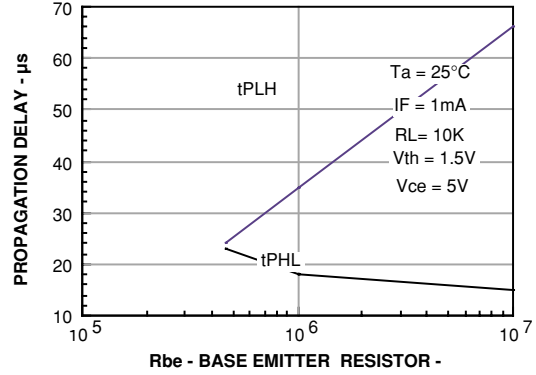

Figure 16. Propagation delay vs. base emitter resistor

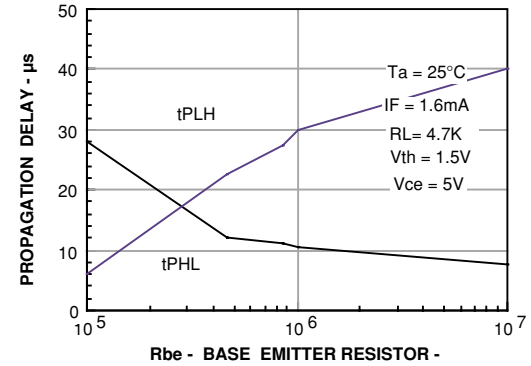

Figure 17. Propagation delay vs. base emitter resistor

