

DIGITRON SEMICONDUCTORS

2N6400-2N6405

SILICON CONTROLLED RECTIFIERS

Available Non-RoHS (standard) or RoHS compliant (add PBF suffix).

Available as "HR" (high reliability) screened per MIL-PRF-19500, JANTX level. Add "HR" suffix to base part number.

MAXIMUM RATINGS

Rating	Symbol	Value	Unit
Peak repetitive off-state voltage ⁽¹⁾ (T _J = -40 to 125°C, sine wave 50 to 60Hz, gate open)			
2N6400		50	Volts
2N6401	V _{DRM}	100	
2N6402	V _{RRM}	200	
2N6403		400	
2N6404		600	
2N6405		800	
On-state RMS current (180° conduction angles), T _C = 100°C)	I _{T(RMS)}	16	Amps
Average on-state current (180° conduction angles, T _C = 100°C)	I _{T(AV)}	10	Amps
Peak non-repetitive surge current (1/2 cycle, sine wave 60Hz, T _J = 90°C)	I _{TSM}	160	Amps
Circuit fusing (t = 8.3ms)	I ² t	145	A ² s
Forward peak gate power (pulse width ≤ 1.0μs, T _C = 100°C)	P _{GM}	20	Watts
Forward average gate power (t = 8.3ms, T _C = 100°C)	P _{G(AV)}	0.5	Watts
Forward peak gate current (Pulse width ≤ 1.0μs, T _C = 100°C)	I _{GM}	2.0	Amps
Operating junction temperature range	T _J	-40 to 125	°C
Storage temperature range	T _{stg}	-40 to 150	°C

1. V_{DRM} and V_{RRM} for all types can be applied on a continuous basis. Ratings apply for zero or negative gate voltage, however, positive gate voltage shall not be applied concurrent with negative potential on the anode. Blocking voltages shall not be tested with a constant current source such that the voltage ratings of the devices are exceeded.

THERMAL CHARACTERISTICS

Characteristic	Symbol	Max	Unit
Thermal resistance, junction to case	R _{θJC}	1.5	°C/W
Maximum lead temperature for soldering purposes 1/8" from case for 10 seconds	T _L	260	°C

ELECTRICAL CHARACTERISTICS (T_C = 25°C unless otherwise noted)

Characteristic	Symbol	Min	Typ	Max	Unit
OFF CHARACTERISTICS					
Peak repetitive forward or reverse blocking current (V _{AK} = rated V _{DRM} or V _{RRM} , gate open)	T _J = 25°C T _J = 125°C	I _{IDRM} , I _{IRRM}	- -	- -	10 2.0 μA mA
ON CHARACTERISTICS					
Peak forward on-state voltage (I _{TM} = 32A peak, pulse width ≤ 1ms, duty cycle ≤ 2%)	V _{TM}	-	-	1.7	Volts
Gate trigger current (continuous dc) (V _D = 12Vdc, R _L = 100ohms)	T _C = 25°C T _C = -40°C	I _{GT}	- -	9.0 60	mA
Gate trigger voltage (continuous dc) (V _D = 12Vdc, R _L = 100ohms)	T _C = 25°C T _C = -40°C	V _{GT}	- -	0.7 2.5	Volts
Gate non-trigger voltage (V _D = 12Vdc, R _L = 100ohms)	T _C = 125°C	V _{GD}	0.2	-	Volts

DIGITRON SEMICONDUCTORS

2N6400-2N6405

SILICON CONTROLLED RECTIFIERS

ON CHARACTERISTICS						
Holding current ($V_D = 12\text{Vdc}$, initiating current = 200mA, gate open)	$T_C = 25^\circ\text{C}$ $T_C = -40^\circ\text{C}$	I_H	-	18 -	40 60	mA
Turn-on time ($I_{TM} = 16\text{A}$, $I_{GT} = 40\text{mA}$, $V_D = \text{rated } V_{DRM}$)		t_{gt}	-	1.0	-	μs
Turn-off time ($I_{TM} = 16\text{A}$, $I_R = 16\text{A}$, $V_D = \text{rated } V_{DRM}$)		t_q	-	15 35	-	μs
DYNAMIC CHARACTERISTICS						
Critical rate of rise of off state voltage ($V_D = \text{rated } V_{DRM}$, exponential waveform)		$T_J = 125^\circ\text{C}$	dv/dt	-	50	$\text{V}/\mu\text{s}$

MECHANICAL CHARACTERISTICS

Case	TO-220AB
Marking	Alpha-numeric
Pin out	See below

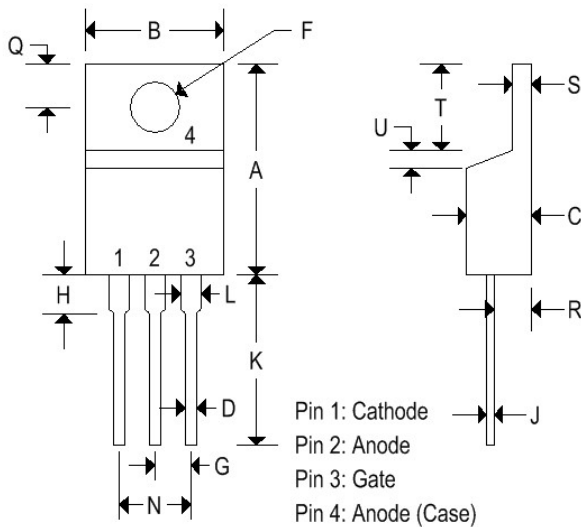

	TO-220AB			
	Inches		Millimeters	
	Min	Max	Min	Max
A	0.575	0.620	14.600	15.750
B	0.380	0.405	9.650	10.290
C	0.160	0.190	4.060	4.820
D	0.025	0.035	0.640	0.890
F	0.142	0.147	3.610	3.730
G	0.095	0.105	2.410	2.670
H	0.110	0.155	2.790	3.930
J	0.014	0.022	0.360	0.560
K	0.500	0.562	12.700	14.270
L	0.045	0.055	1.140	1.390
N	0.190	0.210	4.830	5.330
Q	0.100	0.120	2.540	3.040
R	0.080	0.110	2.040	2.790
S	0.045	0.055	1.140	1.390
T	0.235	0.255	5.970	6.480
U	-	0.050	-	1.270
V	0.045	-	1.140	-
Z	-	0.080	-	2.030

DIGITRON SEMICONDUCTORS

2N6400-2N6405

SILICON CONTROLLED RECTIFIERS

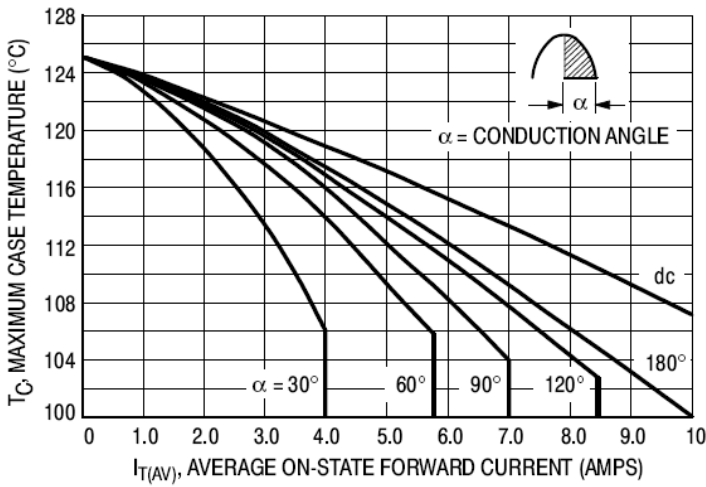
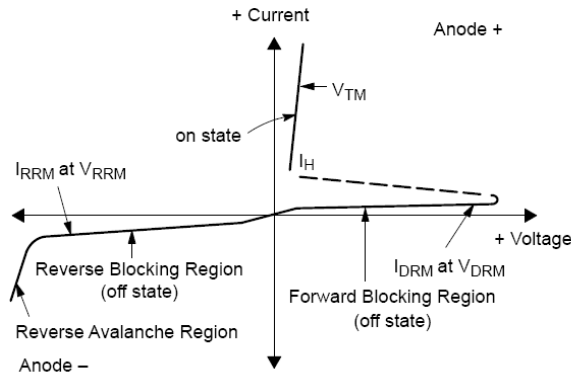

Figure 1. Average Current Derating

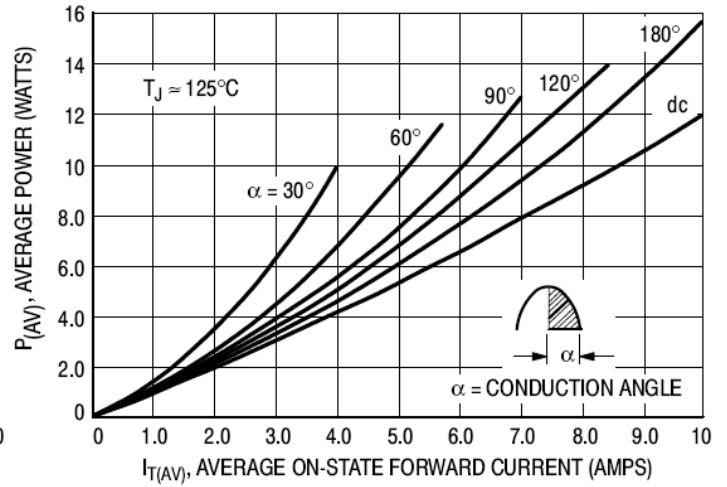

Figure 2. Maximum On-State Power Dissipation

DIGITRON SEMICONDUCTORS

2N6400 SERIES SILICON CONTROLLED RECTIFIERS

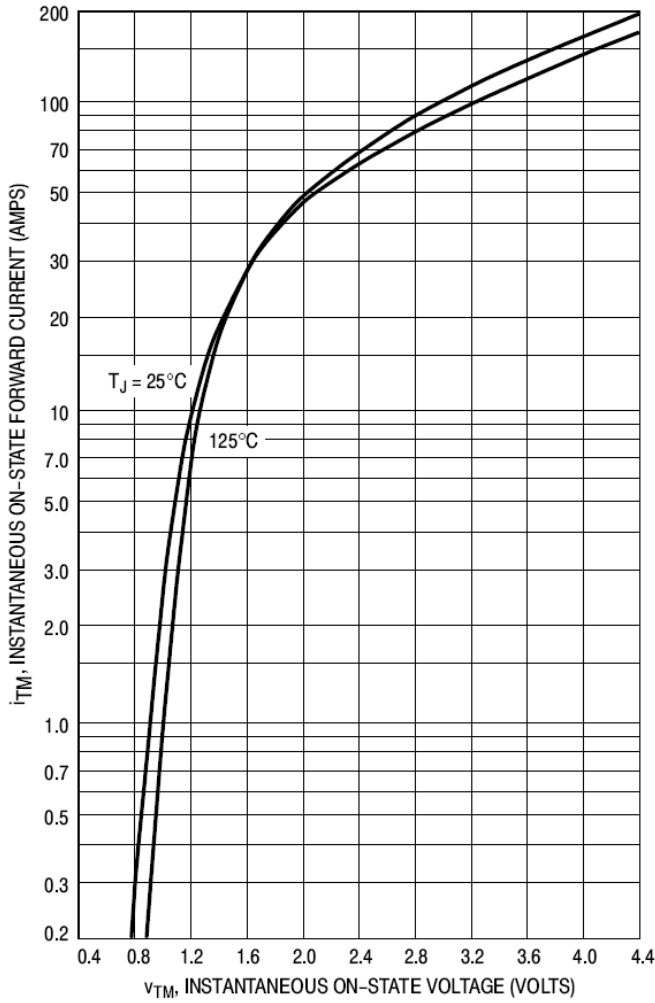

Figure 3. On-State Characteristics

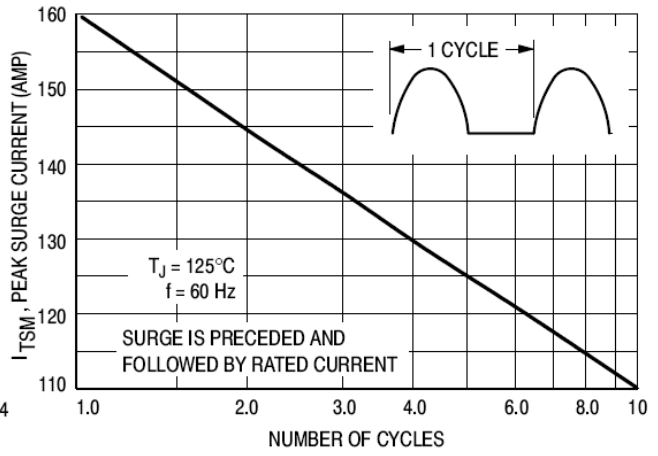

Figure 4. Maximum Non-Repetitive Surge Current

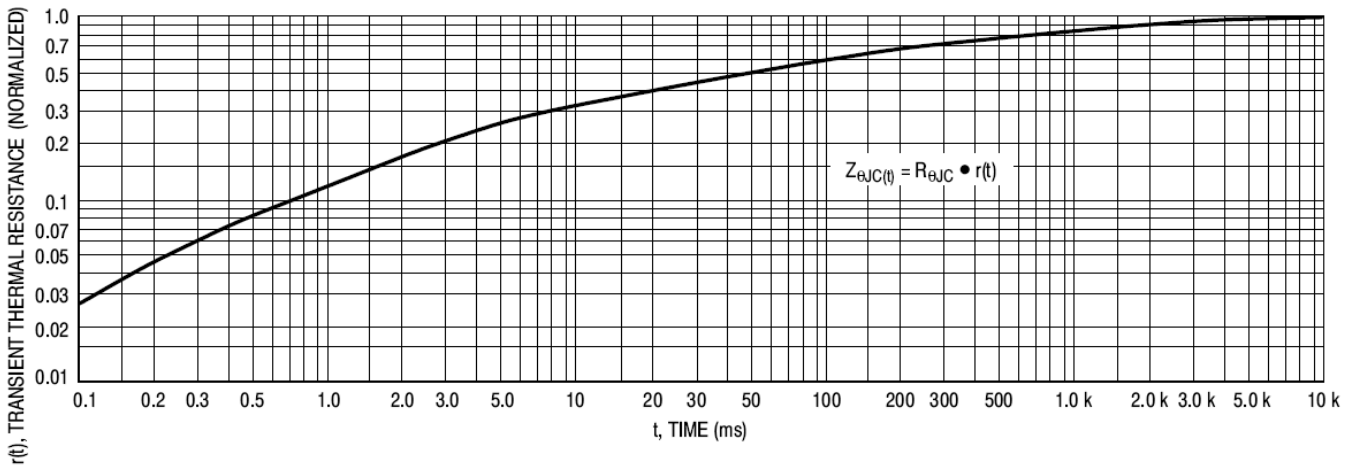

Figure 5. Thermal Response

DIGITRON SEMICONDUCTORS

2N6400 SERIES SILICON CONTROLLED RECTIFIERS

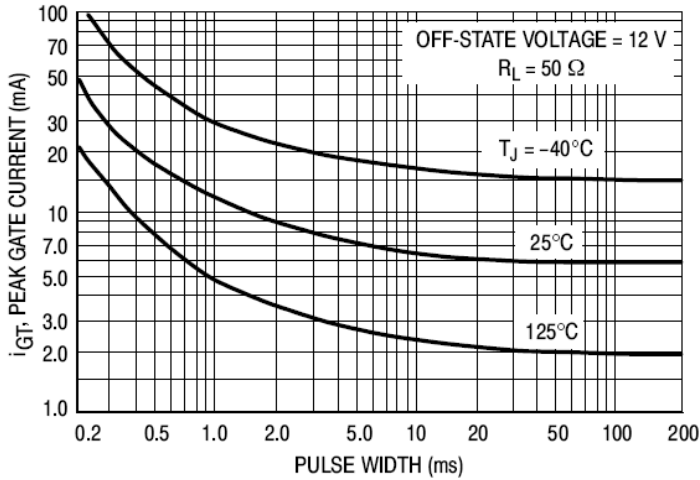

Figure 6. Typical Gate Trigger Current versus Pulse Width

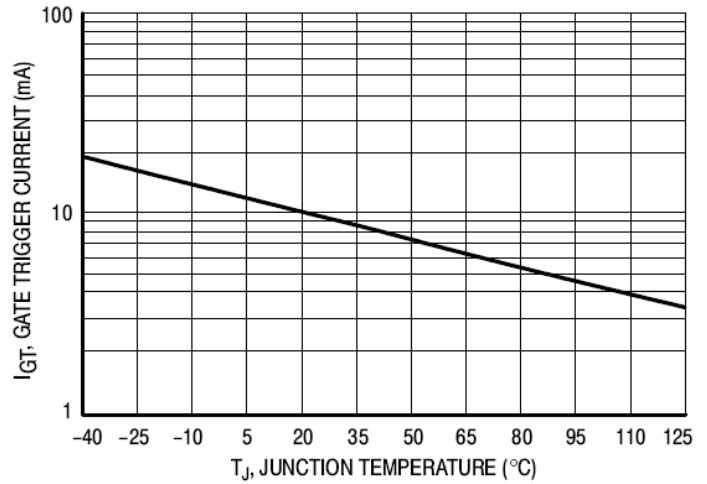

Figure 7. Typical Gate Trigger Current versus Junction Temperature

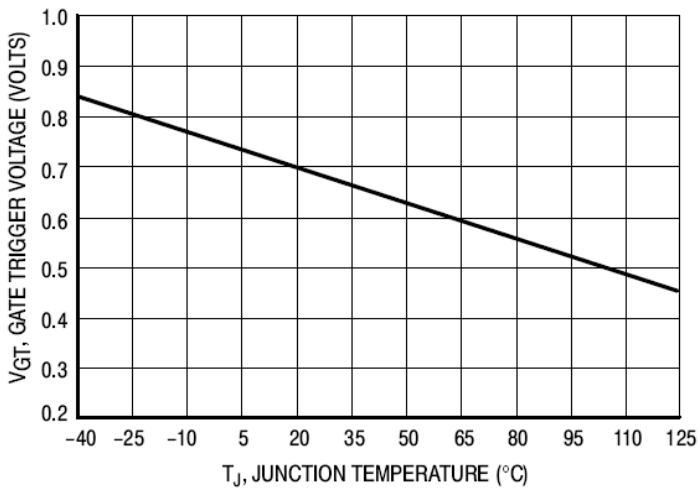

Figure 8. Typical Gate Trigger Voltage versus Junction Temperature

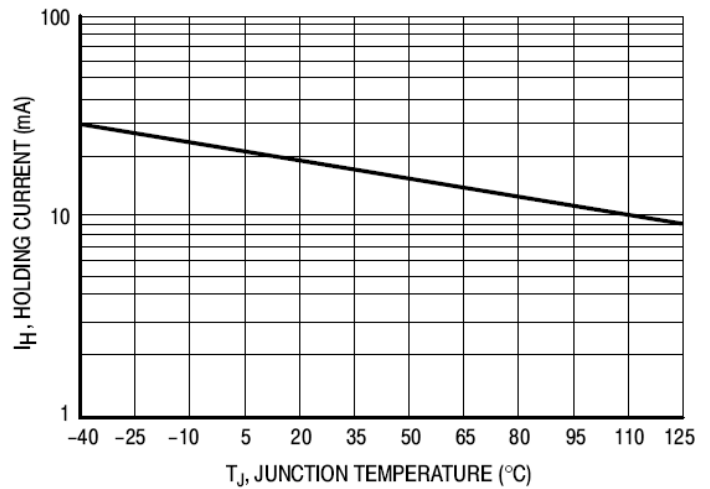

Figure 9. Typical Holding Current versus Junction Temperature