



**Pb-free
HEAT**



AA□101 Series

Alpha-Numeric Display/Case Size 22.8 x 33.0 mm

Features

Case Size	22.8 x 33 mm (W x H)
Product features	<ul style="list-style-type: none"> ▪ Each color has anode common. ▪ A black case is available. ▪ Lead-free soldering compatible ▪ RoHS compliant
Peak wavelength	Orange : 605nm Red : 660nm
Number of Digit	1 Digit
Segment Shape	Arrow Feather Type
Character Height	25.4 mm
Die materials	Orange : GaAsP Red : GaAlAs
Soldering methods	TTW (Through The Wave) soldering and manual soldering
ESD	More than 2kV(HBM)
Packing	Tray

Recommended Applications

Amusement Equipment, Electric Household Appliances, Other General Applications

Emitted Color

Part No.	Material	Emitted Color	Chip/ Segment
Anode Common			
Case Color Black			
AAA101-B	GaAsP	Orange	1
			2
AAR101-B	GaAlAs	Red	1
			2
AAR101-C	GaAlAs	Red	1
			2

Absolute Maximum Ratings

(Ta=25)

Item	Symbol	Absolute Maximum Ratings				Unit
		Orange		Red		
		Chip/Segment				
		1	2	1	2	
Power Dissipation	Pd	60	120	50	100	mW/seg
Forward Current	I _F	25		25		mA/seg
Pulse Forward Current ※1	I _{FRM}	100		100		mA/seg
Derating (Ta=25°C or higher)	ΔI _F	0.33		0.33		mA/°C
	ΔI _{FRM}	1.65		1.65		mA/°C
Reverse Voltage	V _R	4	8	4	8	V
Operating Temperature	T _{opr}	-20~+85		-20~+85		°C
Storage Temperature	T _{stg}	-20~+100		-20~+100		°C

 ※1 I_{FRM} Measurement condition : Duty 1/5, f = 1kHz

Electro-Optical Characteristics

(Ta=25)

Item	Conditions	Symbol		Characteristics				Unit
				Orange		Red		
				Chip/Segment				
				1	2	1	2	
Luminous Intensity (-B Product)	I _F =20mA	I _v	MIN.	2	4	6	12	mcd/seg
			TYP.	4	8	12	24	
Luminous Intensity (-C Product)	I _F =20mA	I _v	MIN.	-	-	12	24	mcd/seg
			TYP.	-	-	15	30	
Forward Voltage	I _F =20mA	V _F	TYP.	2.2	4.4	1.7	3.4	V/seg
			MAX.	2.5	5.0	2.0	4.0	
Reverse Current	-	I _R	MAX.	100(V _R =4V)	100(V _R =8V)	100(V _R =4V)	100(V _R =8V)	μ A/seg
Peak Wavelength	I _F =20mA	λ _p	TYP.	605		660		nm
Spectral Line Half Width	I _F =20mA	Δλ	TYP.	30		30		nm

Technical Data(Orange)

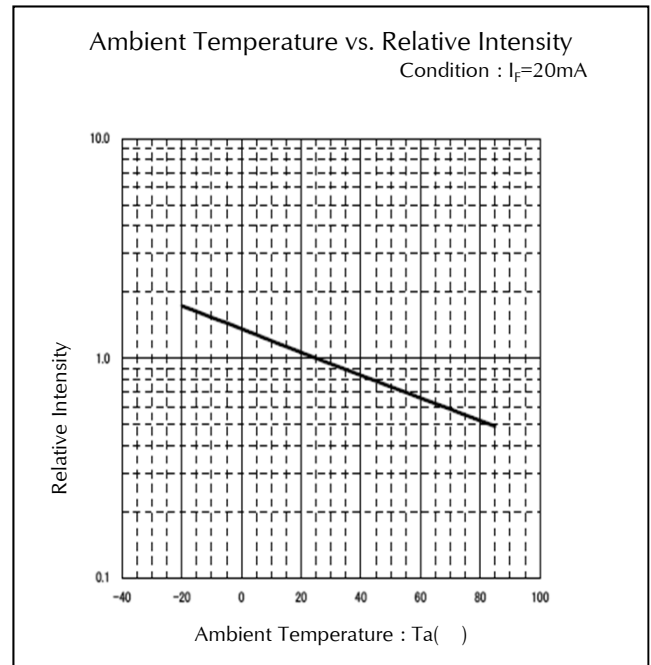
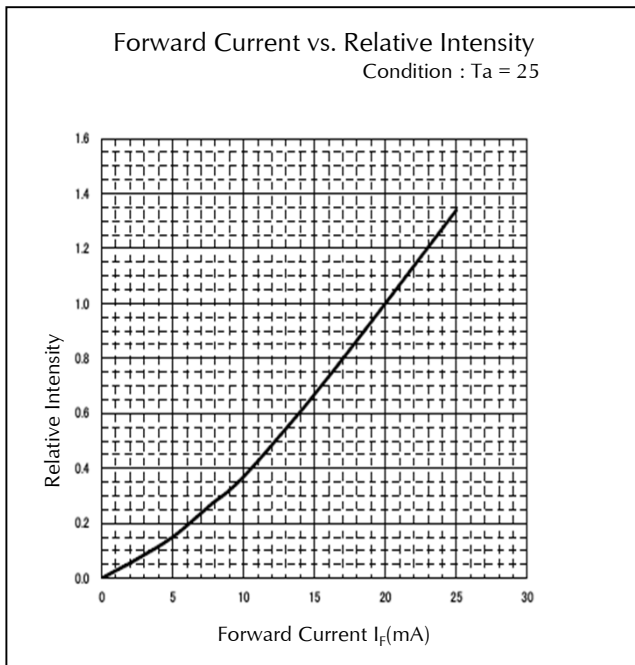
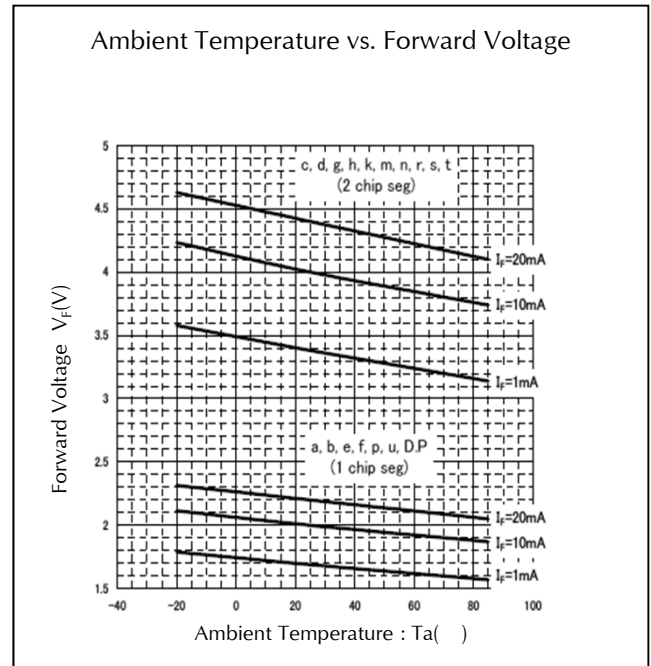
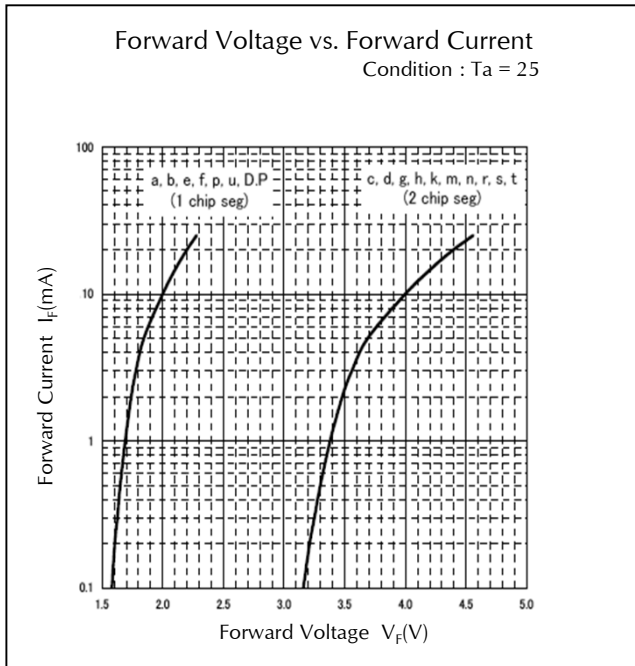

Technical Data(Orange)

Ambient Temperature vs. Maximum Forward Current

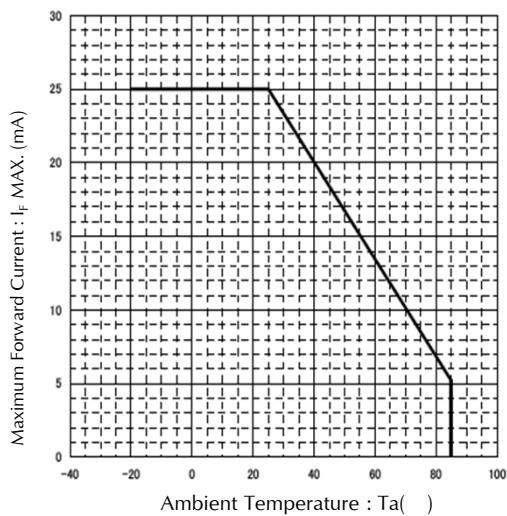

Ambient Temperature vs. Power Dissipation

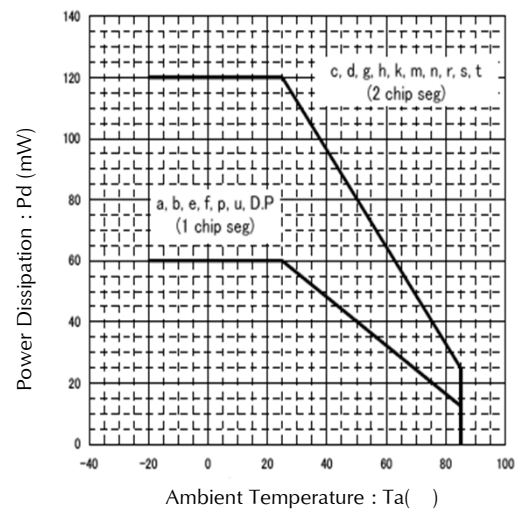

Duty Factor vs. Maximum Tolerable Pulse Forward Current
Condition : Ta = 25

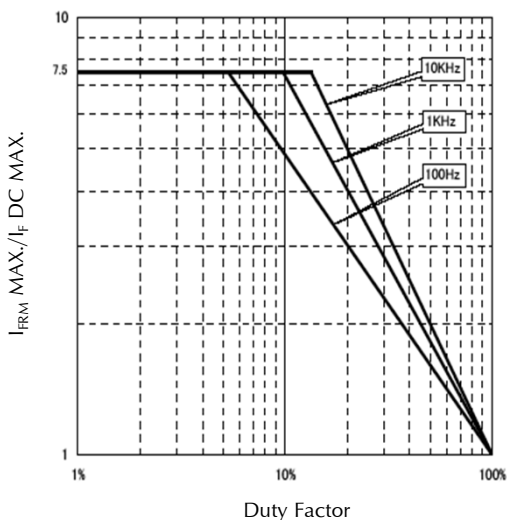

Technical Data(Red)

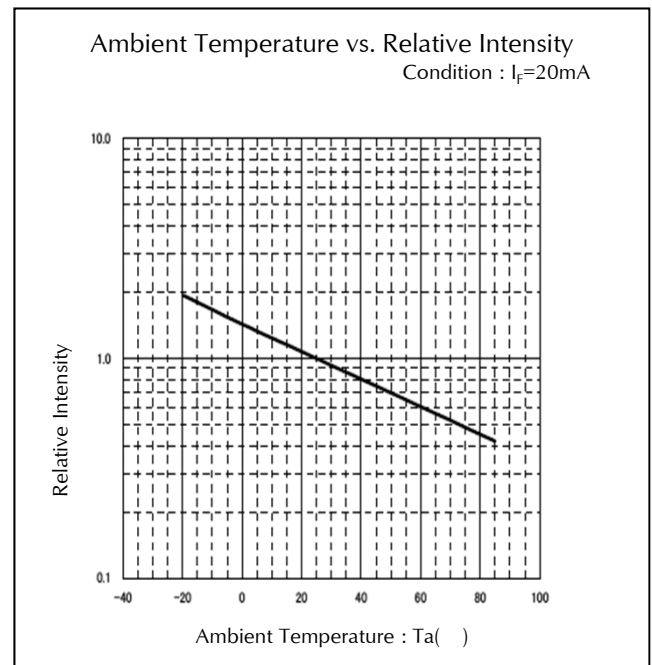
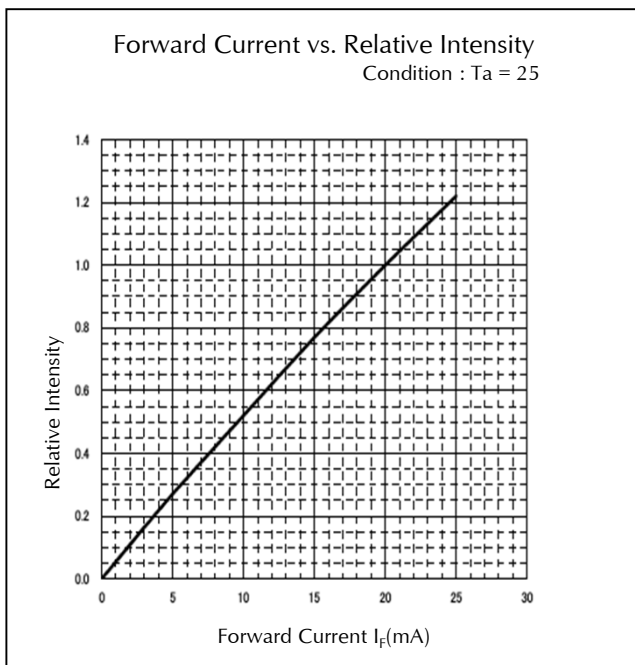
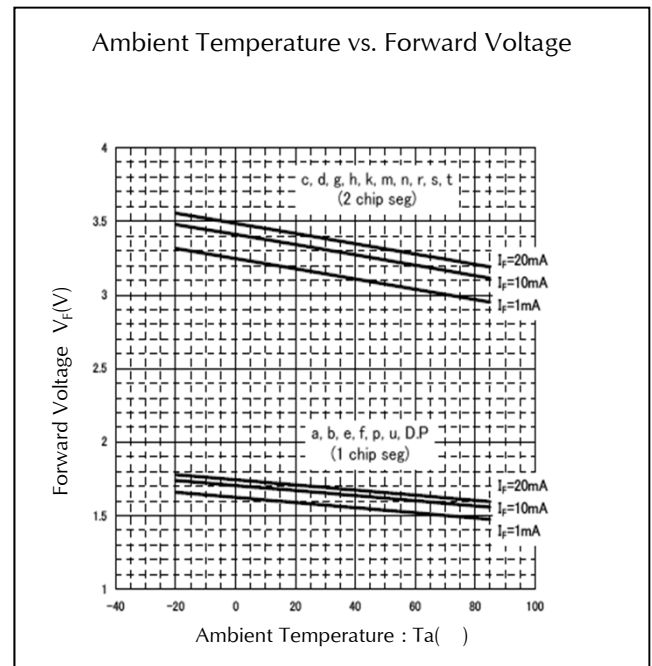
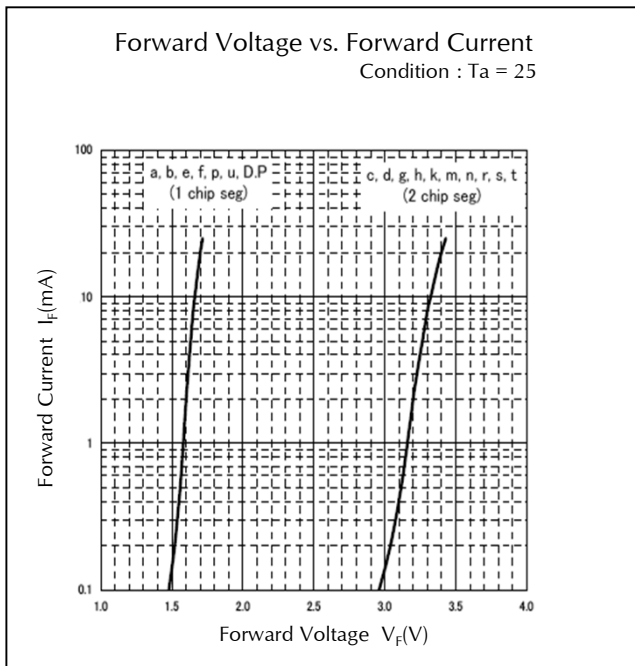

Technical Data(Red)

Ambient Temperature vs. Maximum Forward Current

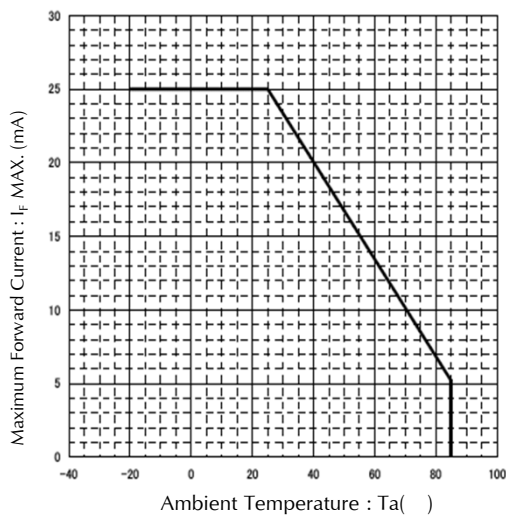

Ambient Temperature vs. Power Dissipation

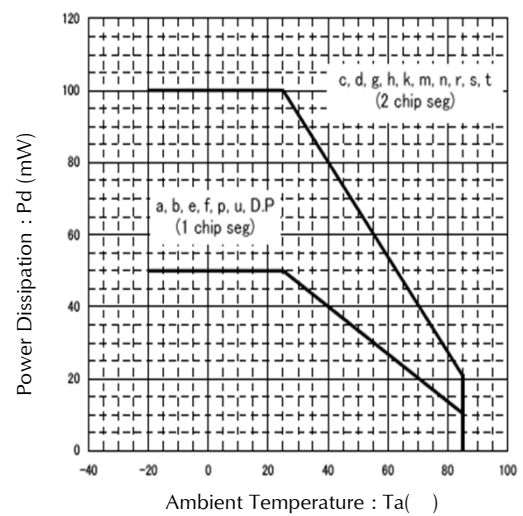

Duty Factor vs. Maximum Tolerable Pulse Forward Current
Condition : Ta = 25

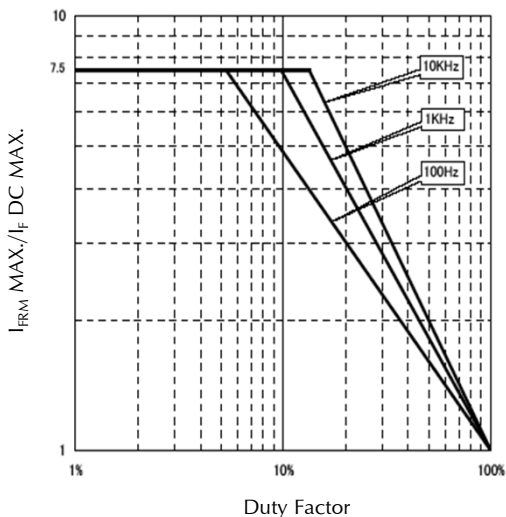

Package Dimensions

(Unit: mm)

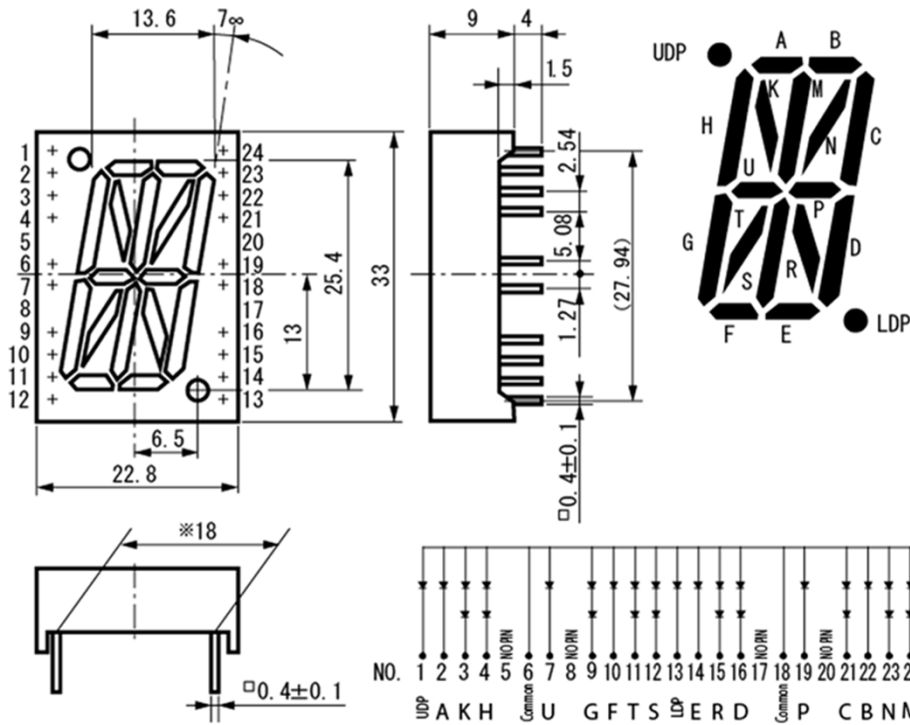

The length of lead base.

Recommended Soldering Pattern

(Unit: mm)

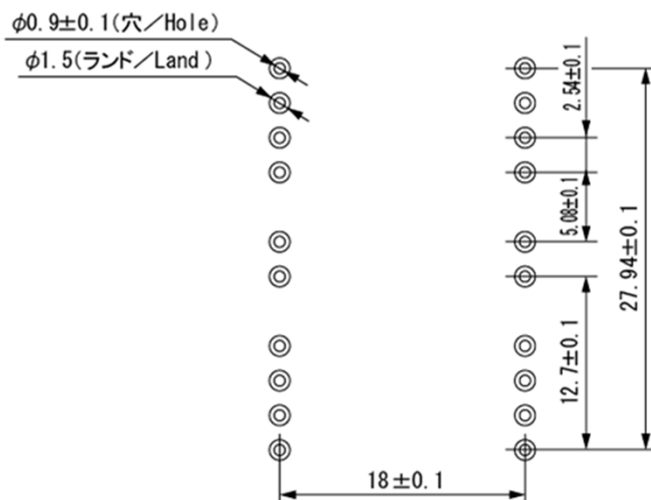

TTW (Through The Wave) soldering Conditions

Pre-heating	100 60 s	(MAX.) Resin surface temperature (MAX.)
Solder Bath Temp.	265	(MAX.)
Dipping Time	5 s	(MAX.)
Position	At least 2.0 mm away from the root of lead	

- 1) The dip soldering process shall be 2 times maximum.
- 2) The product shall be cooled to normal temperature before the second dipping process.

Manual Soldering Conditions

Iron tip temp.	360	(MAX.)
Soldering time and frequency	3 s 2 times	(MAX.) (MAX.)
Position	At least 2.0 mm away from the root of lead	

Reliability Testing Result

Reliability Testing Result	Applicable Standard	Testing Conditions	Duration	Failure
Room Temp. Operating Life	EIAJ ED-4701/100(101)	Ta = 25°C, If = Maximum Rated Current/seg	1,000 h	0/10
Resistance to Soldering Heat	EIAJ ED-4701/300(302)	260±5°C, 3mm from package base	10s	0/10
Temperature Cycling	EIAJ ED-4701/100(105)	Minimum Rated Storage Temperature(30min) ~Normal Temperature(15min) ~Maximum Rated Storage Temperature(30min) ~Normal Temperature(15min)	5 cycles	0/10
Wet High Temp. Storage Life	EIAJ ED-4701/100(103)	Ta = 60±2°C, RH = 90±5%	1,000 h	0/10
High Temp. Storage Life	EIAJ ED-4701/200(201)	Ta = Maximum Rated Storage Temperature	1,000 h	0/10
Low Temp. Storage Life	EIAJ ED-4701/200(202)	Ta = Minimum Rated Storage Temperature	1,000 h	0/10
Lead Tension	EIAJ ED-4701/400(401)	5N, 1time	10s	0/10
Vibration, Variable Frequency	EIAJ ED-4701/400(403)	98.1m/s ² (10G), 100 ~ 2KHz sweep for 20min., XYZ each direction	2 h	0/10
Lead Bend	EIAJ ED-4701/400(401)	2.5N, 0° ↔ 90°	Twice	0/10
Shock	JIS C 7201 A-8	It falls on wood engraving from height of 75cm.	3 times	0/10

Failure Criteria

Items	Symbols	Conditions	Failure criteria
Luminous Intensity	Iv	If Value of each product Luminous Intensity	Testing Min. Value < Spec. Min. Value x 0.5
Forward Voltage	V _F	If Value of each product Forward Voltage	Testing Max. Value ≥ Spec. Max. Value x 1.2
Reverse Current	I _R	V _R = Maximum Rated Reverse Voltage V	Testing Max. Value ≥ Spec. Max. Value x 2.5
Cosmetic Appearance	-	-	Occurrence of notable decoloration, deformation and cracking

Special Notice to Customers Using the Products and Technical Information Shown in This Data Sheet

- 1) The technical information shown in the data sheets are limited to the typical characteristics and circuit examples of the referenced products. It does not constitute the warranting of industrial property nor the granting of any license.
- 2) For the purpose of product improvement, the specifications, characteristics and technical data described in the data sheets are subject to change without prior notice. Therefore it is recommended that the most updated specifications be used in your design.
- 3) When using the products described in the data sheets, please adhere to the maximum ratings for operating voltage, heat dissipation characteristics, and other precautions for use. We are not responsible for any damage which may occur if these specifications are exceeded.
- 4) The products that have been described to this catalog are manufactured so that they will be used for the electrical instrument of the benchmark (OA equipment, telecommunications equipment, AV machine, home appliance and measuring instrument).
The application of aircrafts, space borne application, transportation equipment, medical equipment and nuclear power control equipment, etc. needs a high reliability and safety, and the breakdown and the wrong operation might influence the life or the human body. Please consult us beforehand if you plan to use our product for the usages of aircrafts, space borne application, transportation equipment, medical equipment and nuclear power control equipment, etc. except OA equipment, telecommunications equipment, AV machine, home appliance and measuring instrument.
- 5) In order to export the products or technologies described in this data sheet which are under the "Foreign Exchange and Foreign Trade Control Law," it is necessary to first obtain an export permit from the Japanese government.
- 6) No part of this data sheet may be reprinted or reproduced without prior written permission from Stanley Electric Co., Ltd.
- 7) The most updated edition of this data sheet can be obtained from the address below:
<http://www.stanley-components.com>