

PolarHT™ Power MOSFET

IXTH 88N30P
IXTK 88N30P
IXTQ 88N30P
IXTT 88N30P

$V_{DSS} = 300 \text{ V}$
 $I_{D25} = 88 \text{ A}$
 $R_{DS(on)} \leq 40 \text{ m}\Omega$

N-Channel Enhancement Mode
Avalanche Rated

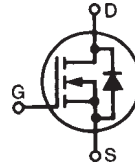

Symbol	Test Conditions	Maximum Ratings	
V_{DSS}	$T_J = 25^\circ\text{C to } 150^\circ\text{C}$	300	V
V_{DGR}	$T_J = 25^\circ\text{C to } 150^\circ\text{C}; R_{GS} = 1 \text{ M}\Omega$	300	V
V_{GS}	Continuous	± 20	V
V_{GSM}	Transient	± 30	V
I_{D25}	$T_C = 25^\circ\text{C}$	88	A
$I_{D(RMS)}$	External lead current limit	75	A
I_{DM}	$T_C = 25^\circ\text{C}$, pulse width limited by T_{JM}	220	A
I_{AR}	$T_C = 25^\circ\text{C}$	60	A
E_{AR}	$T_C = 25^\circ\text{C}$	60	mJ
E_{AS}	$T_C = 25^\circ\text{C}$	2.0	J
dv/dt	$I_S \leq I_{DM}$, $di/dt \leq 100 \text{ A}/\mu\text{s}$, $V_{DD} \leq V_{DSS}$ $T_J \leq 150^\circ\text{C}$, $R_G = 4 \Omega$	10	V/ns
P_D	$T_C = 25^\circ\text{C}$	600	W
T_J		-55 ... +150	$^\circ\text{C}$
T_{JM}		150	$^\circ\text{C}$
T_{stg}		-55 ... +150	$^\circ\text{C}$
T_L	1.6 mm (0.062 in.) from case for 10 s	300	$^\circ\text{C}$
T_{SOLD}	Plastic body for 10 s	260	$^\circ\text{C}$
M_d	Mounting torque	1.13/10	Nm/lb.in.
Weight	TO-247	6.0	g
	TO-264	10	g
	TO-3P & TO-268	5.5	g

TO-247 (IXTH)

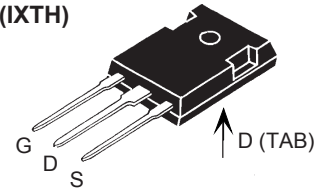

TO-264 (IXTK)

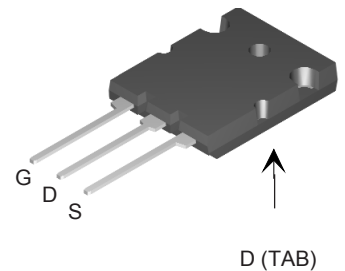

TO-3P (IXTQ)

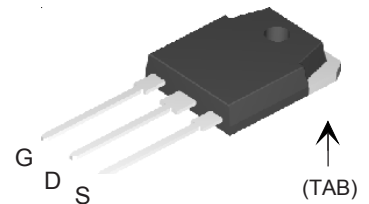

TO-268 (IXTT)

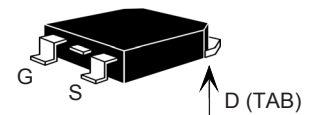

G = Gate D = Drain
S = Source TAB = Drain

Features

- International standard package
- Unclamped Inductive Switching (UIS) rated
- Low package inductance
- easy to drive and to protect

Advantages

- Easy to mount
- Space savings
- High power density

Symbol	Test Conditions ($T_J = 25^\circ\text{C}$, unless otherwise specified)	Characteristic Values		
		Min.	Typ.	Max.
BV_{DSS}	$V_{GS} = 0 \text{ V}$, $I_D = 250 \mu\text{A}$	300		V
$V_{GS(th)}$	$V_{DS} = V_{GS}$, $I_D = 250 \mu\text{A}$	2.5		5.0 V
I_{GSS}	$V_{GS} = \pm 20 \text{ V}_{DC}$, $V_{DS} = 0$			$\pm 100 \text{ nA}$
I_{DSS}	$V_{DS} = V_{DSS}$ $V_{GS} = 0 \text{ V}$ $T_J = 125^\circ\text{C}$			100 μA
				1 mA
$R_{DS(on)}$	$V_{GS} = 10 \text{ V}$, $I_D = 0.5 I_{D25}$ Pulse test, $t \leq 300 \mu\text{s}$, duty cycle $d \leq 2 \%$			40 m Ω

Symbol	Test Conditions	Characteristic Values ($T_J = 25^\circ\text{C}$ unless otherwise specified)		
		Min.	Typ.	Max.
g_{fs}	$V_{DS} = 10\text{ V}; I_D = 0.5 I_{D25}$, pulse test	45	60	S
C_{iss}	$V_{GS} = 0\text{ V}, V_{DS} = 25\text{ V}, f = 1\text{ MHz}$		6300	pF
C_{oss}			950	pF
C_{rss}			190	pF
$t_{d(on)}$	$V_{GS} = 10\text{ V}, V_{DS} = 0.5 V_{DSS}, I_D = 60\text{ A}$ $R_G = 3.3\ \Omega$ (External)		25	ns
t_r			24	ns
$t_{d(off)}$			96	ns
t_f			25	ns
$Q_{g(on)}$	$V_{GS} = 10\text{ V}, V_{DS} = 0.5 V_{DSS}, I_D = 0.5 I_{D25}$		180	nC
Q_{gs}			44	nC
Q_{gd}			90	nC
R_{thJC}	TO-247 and TO-3P TO-264			0.21°C/W
R_{thCS}			0.21	$^\circ\text{C/W}$
R_{thCS}			0.15	$^\circ\text{C/W}$

Source-Drain Diode		Characteristic Values ($T_J = 25^\circ\text{C}$, unless otherwise specified)		
Symbol	Test Conditions	Min.	Typ.	Max.
I_S	$V_{GS} = 0\text{ V}$			88 A
I_{SM}	Repetitive			220 A
V_{SD}	$I_F = I_S, V_{GS} = 0\text{ V}$, Pulse test, $t \leq 300\ \mu\text{s}$, duty cycle $d \leq 2\%$			1.5 V
t_{rr}	$I_F = 25\text{ A}, -di/dt = 100\text{ A}/\mu\text{s}$ $V_R = 100\text{ V}, V_{GS} = 0\text{ V}$		250	ns
Q_{RM}			3.3	μC

Characteristic Curves

Fig. 1. Output Characteristics @ 25°C

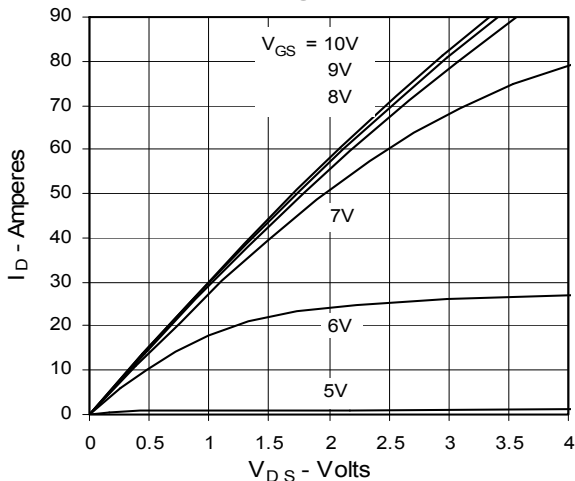
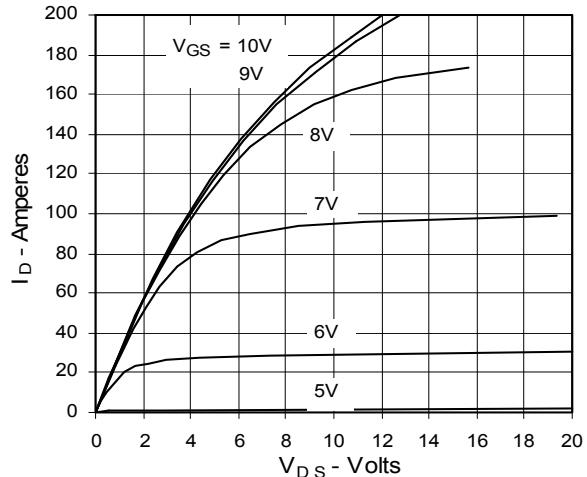

Fig. 2. Extended Output Characteristics @ 25°C



IXYS reserves the right to change limits, test conditions, and dimensions.

IXYS MOSFETs and IGBTs are covered by 4,835,592 4,931,844 5,049,961 5,237,481 6,162,665 6,404,065 B1 6,683,344 6,727,585
 one or more of the following U.S. patents: 4,850,072 5,017,508 5,063,307 5,381,025 6,259,123 B1 6,534,343 6,710,405 B2 6,759,692
 4,881,106 5,034,796 5,187,117 5,486,715 6,306,728 B1 6,583,505 6,710,463 6,771,478 B2

Fig. 3. Output Characteristics @ 125°C

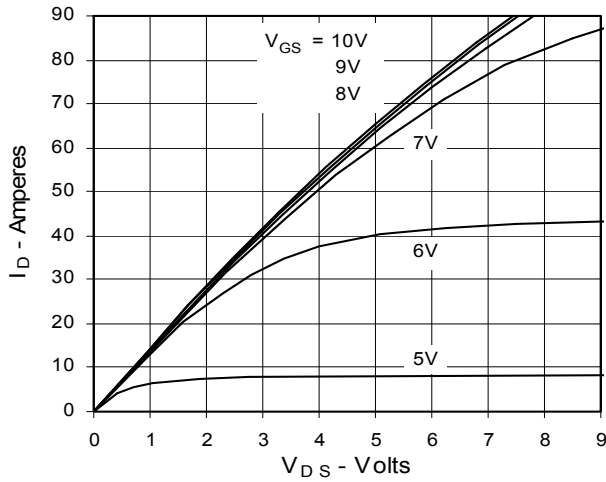

Fig. 4. $R_{DS(on)}$ Normalized to 0.5 I_{D25} Value vs. Junction Temperature

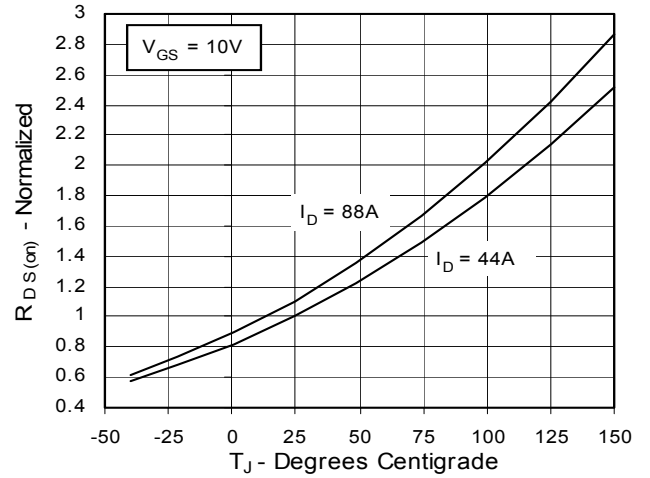

Fig. 5. $R_{DS(on)}$ Normalized to 0.5 I_{D25} Value vs. I_D

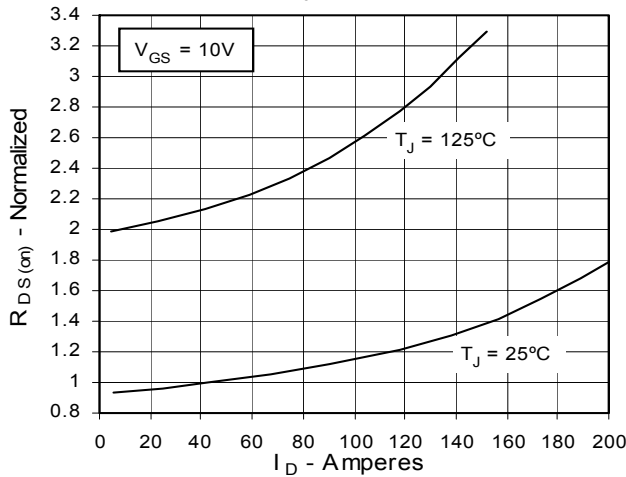

Fig. 6. Drain Current vs. Case Temperature

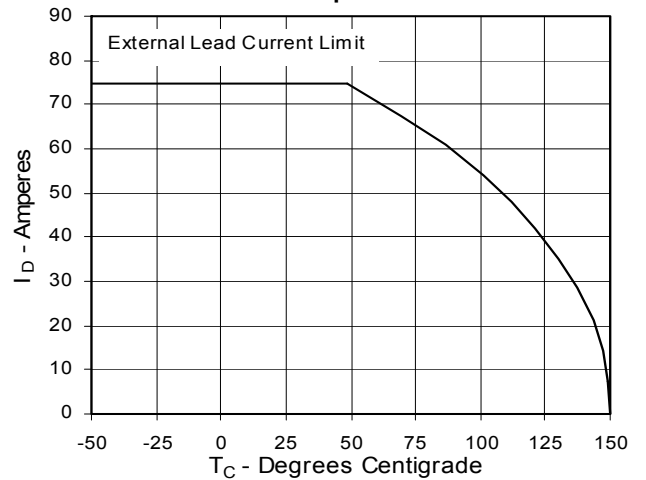

Fig. 7. Input Admittance

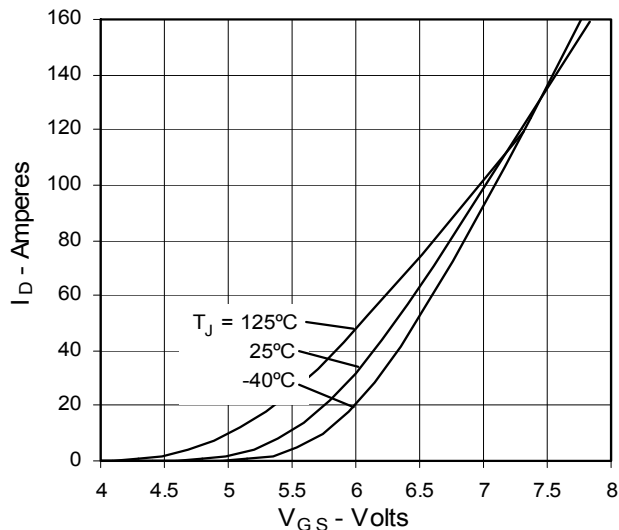

Fig. 8. Transconductance

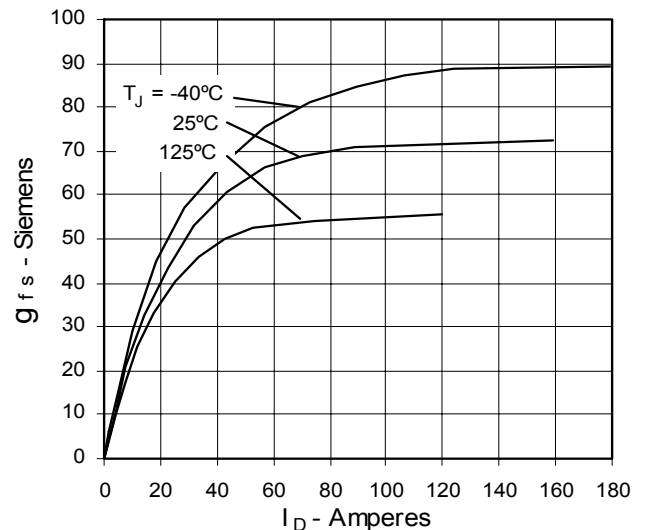

Fig. 9. Source Current vs. Source-To-Drain Voltage

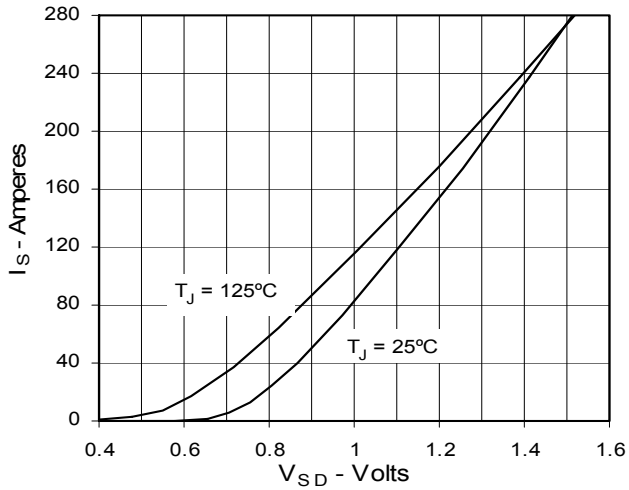

Fig. 10. Gate Charge

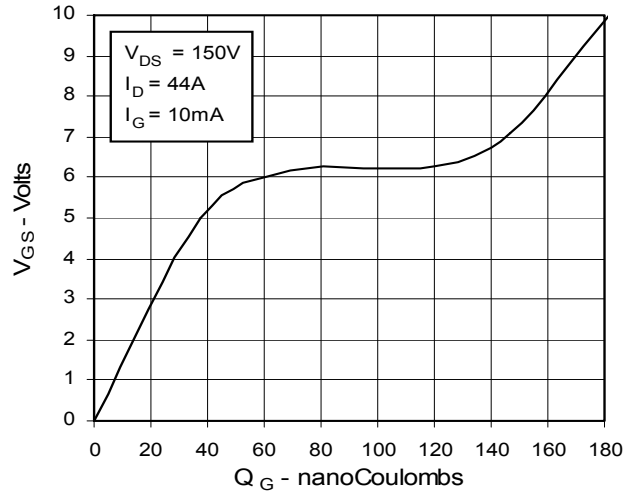

Fig. 11. Capacitance

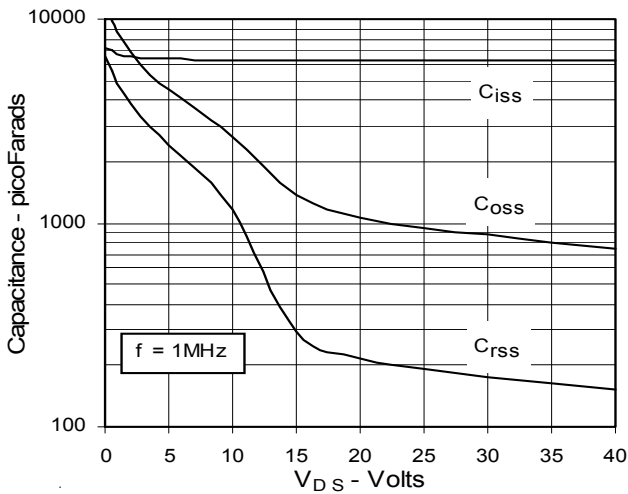

Fig. 12. Forward-Bias Safe Operating Area

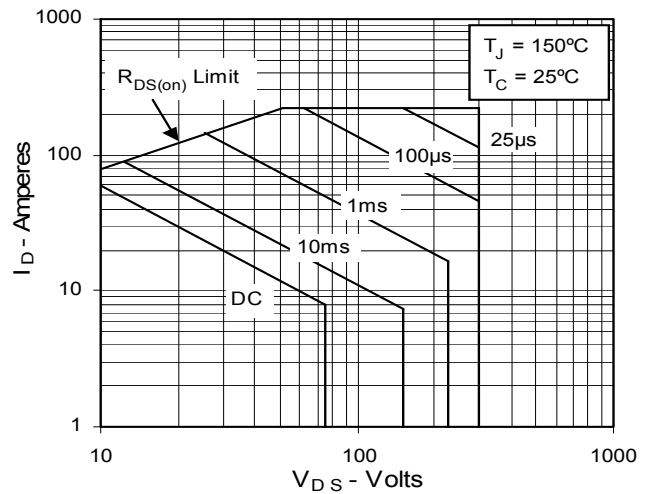
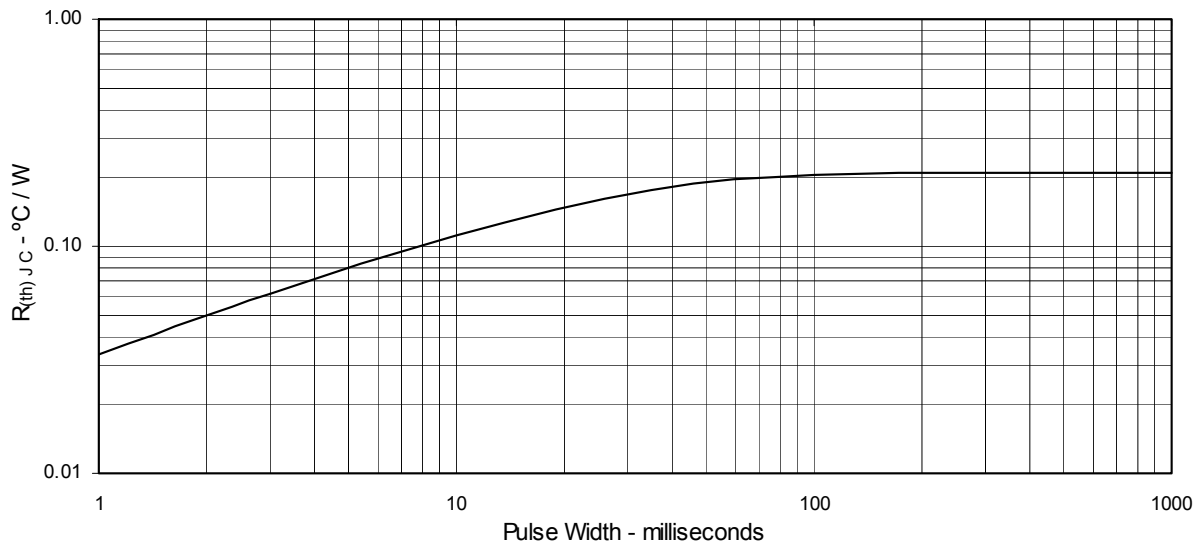
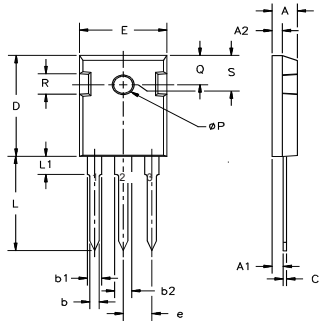

Fig. 13. Maximum Transient Thermal Resistance



TO-247 (IXTH) Outline



Terminals:
 1. Gate 2,4. Drain
 3. Source

Dim.	Millimeter		Inches	
	Min.	Max.	Min.	Max.
A	4.7	5.3	.185	.209
A ₁	2.2	2.54	.087	.102
A ₂	2.2	2.6	.059	.098
b	1.0	1.4	.040	.055
b ₁	1.65	2.13	.065	.084
b ₂	2.87	3.12	.113	.123
C	.4	.8	.016	.031
D	20.80	21.46	.819	.845
E	15.75	16.26	.610	.640
e	5.20	5.72	0.205	0.225
L	19.81	20.32	.780	.800
L1		4.50		.177
∅P	3.55	3.65	.140	.144
Q	5.89	6.40	0.232	0.252
R	4.32	5.49	.170	.216
S	6.15	BSC	242	BSC

TO-3P (IXTQ) Outline

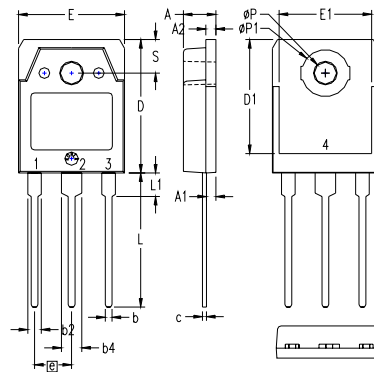

1 - GATE
 2 - DRAIN (COLLECTOR)
 3 - SOURCE (EMITTER)
 4 - DRAIN (COLLECTOR)

SYM	INCHES		MILLIMETERS	
	MIN	MAX	MIN	MAX
A	.185	.193	4.70	4.90
A1	.051	.059	1.30	1.50
A2	.057	.065	1.45	1.65
b	.035	.045	0.90	1.15
b2	.075	.087	1.90	2.20
b4	.114	.126	2.90	3.20
c	.022	.031	0.55	0.80
D	.780	.799	19.80	20.30
D1	.665	.677	16.90	17.20
E	.610	.622	15.50	15.80
E1	.531	.539	13.50	13.70
e	.215 BSC		5.45 BSC	
L	.779	.795	19.80	20.20
L1	.134	.142	3.40	3.60
∅P	.126	.134	3.20	3.40
∅P1	.272	.280	6.90	7.10
S	.193	.201	4.90	5.10

TO-268 (IXTT) Outline

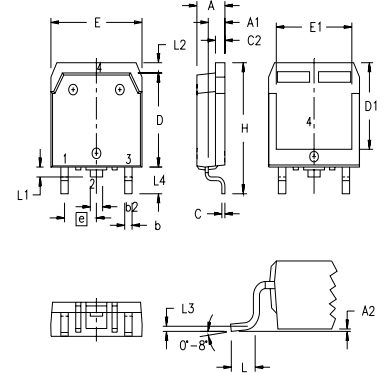

Terminals:
 1. Gate 2,4. Drain
 3. Source

SYM	INCHES		MILLIMETERS	
	MIN	MAX	MIN	MAX
A	.193	.201	4.90	5.10
A1	.106	.114	2.70	2.90
A2	.001	.010	0.02	0.25
b	.045	.057	1.15	1.45
b2	.075	.083	1.90	2.10
C	.016	.026	0.40	0.65
C2	.057	.063	1.45	1.60
D	.543	.551	13.80	14.00
D1	.488	.500	12.40	12.70
E	.624	.632	15.85	16.05
E1	.524	.535	13.30	13.60
e	.215 BSC		5.45 BSC	
H	.736	.752	18.70	19.10
L	.094	.106	2.40	2.70
L1	.047	.055	1.20	1.40
L2	.039	.045	1.00	1.15
L3	.010 BSC		0.25 BSC	
L4	.150	.161	3.80	4.10

TO-264 (IXTK) Outline

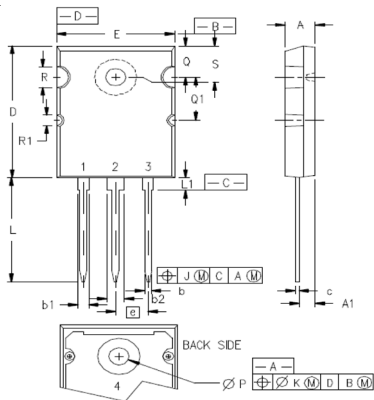

1 - GATE
 2, 4 - DRAIN (COLLECTOR)
 3 - SOURCE (EMITTER)

SYM	INCHES		MILLIMETERS	
	MIN	MAX	MIN	MAX
A	.185	.209	4.70	5.31
A1	.102	.118	2.59	3.00
b	.037	.055	0.94	1.40
b1	.087	.102	2.21	2.59
b2	.110	.126	2.79	3.20
c	.017	.029	0.43	0.74
D	1.007	1.047	25.58	26.59
E	.760	.799	19.30	20.29
e	.215 BSC		5.46 BSC	
J	.000	.010	0.00	0.25
K	.000	.010	0.00	0.25
L	.779	.842	19.79	21.39
L1	.087	.102	2.21	2.59
∅P	.122	.138	3.10	3.51
Q	.240	.256	6.10	6.50
Q1	.330	.346	8.38	8.79
∅R	.155	.187	3.94	4.75
∅R1	.085	.093	2.16	2.36
S	.243	.253	6.17	6.43