

GENERAL DESCRIPTION

The LM2576, LM2576M series of regulators are monolithic integrated circuits that provide all the active functions for a step-down (buck) switching regulator, capable of driving 3A load with excellent line and load regulation. These devices are available in fixed output voltages of 3.3V, 5V, 12V, 15V (1.5V, 1.8V, 2.5V the LM2576M only) and adjustable output versions.

Requiring a minimum number of external components, these regulators are simple to use and include internal frequency compensation and a fixed-frequency oscillator.

The LM2576, LM2576M series offers a high-efficiency replacement for popular three-terminal linear regulators. It substantially reduces the size of the heat sink, and in some cases no heat sink is required.

A standard series of inductors optimized for use with the LM2576, LM2576M are available from several different manufacturers. This feature greatly simplifies the design of switch-mode power supplies.

Other features include a guaranteed $\pm 4\%$ tolerance on output voltage within specified input voltages and output load conditions, and $\pm 10\%$ on the oscillator frequency. External shutdown is included, featuring 50 μ A (typical) standby current. The output switch includes cycle-by-cycle current limiting, as well as thermal shutdown for full protection under fault conditions.

FEATURES

- 1.5V, 1.8V, 2.5V, 3.3V, 5V, 12V, 15V and adjustable output versions
- Adjustable version output voltage range, 1.23V to 37V $\pm 4\%$ max over line and load conditions
- Guaranteed 3A output current
- Wide input voltage range, 40V
- Requires only 4 external components
- 52 kHz fixed frequency oscillator
- TTL shutdown capability, low power standby mode
- High efficiency
- Uses readily available standard inductors
- Thermal shutdown and current limit protection

APPLICATIONS

- Simple high-efficiency step-down (buck) regulator
- Efficient pre-regulator for linear regulators
- On-card switching regulators
- Positive to negative converter (Buck-Boost)

TYPICAL APPLICATION (Fixed Output Voltage Versions)

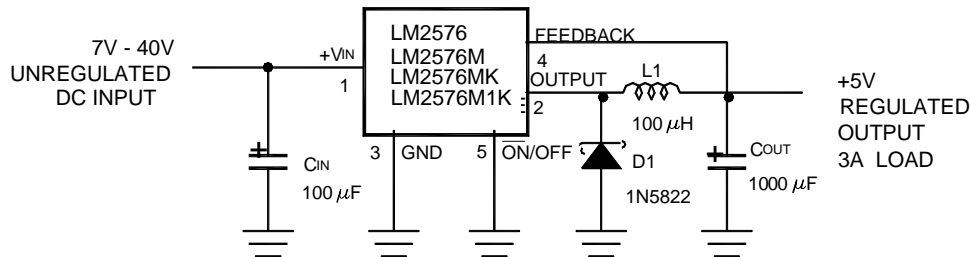
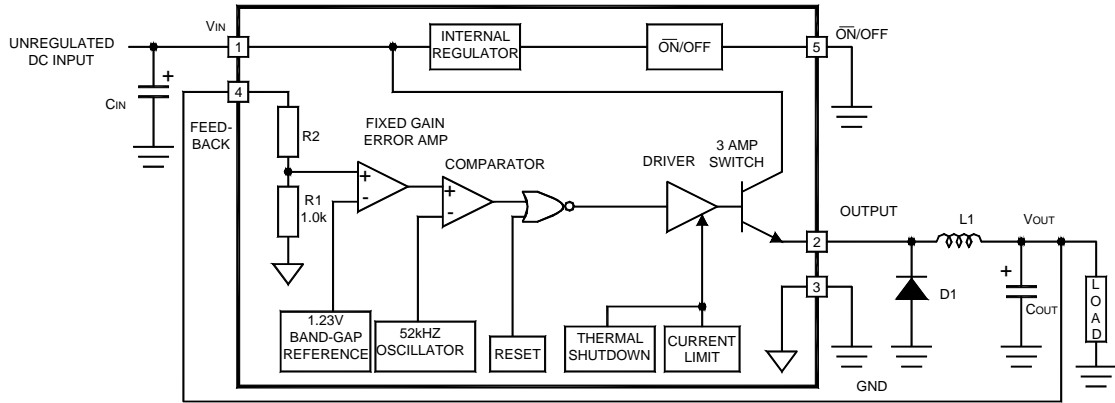

FIGURE 1.

BLOCK DIAGRAM



- 1.5V, R2=220Ω
- 1.8V, R2=467Ω
- 2.5V, R2=1.036Ω
- 3.3V, R2 = 1.7K
- 5V, R2 = 3.1K
- 12V, R2 = 8.84K
- 15V, R2 = 11.3K
- For ADJ, Version
R1 = Open, R2 = 0Ω

ORDERING INFORMATION

Temperature Range	Output Voltage							
	1.5	1.8	2.5	3.3	5.0	12	15	ADJ
-40°C ≤ T _A ≤ 125°C				LM2576 -3.3	LM2576 -5.0	LM2576 -12	LM2576 -15	LM2576 -ADJ
	LM2576M -1.5	LM2576M -1.8	LM2576M -2.5	LM2576M -3.3	LM2576M -5.0	LM2576M -12	LM2576M -15	LM2576M -ADJ
	LM2576MK -1.5	LM2576MK -1.8	LM2576MK -2.5	LM2576MK -3.3	LM2576MK -5.0	LM2576MK -12	LM2576MK -15	LM2576MK -ADJ
	LM2576M1K -1.5	LM2576M1K -1.8	LM2576M1K -2.5	LM2576M1K -3.3	LM2576M1K -5.0	LM2576M1K -12	LM2576M1K -15	LM2576M1K -ADJ

◆ **MARKING INFORMATION & PIN CONFIGURATIONS (Top View)**

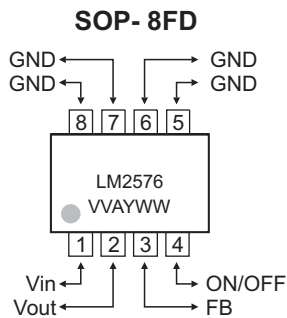

V V, VVV = Output Voltage (33 = 3.3V, 120= 12V, A =A dj)
A = Assembly Location
Y =Year
W W =Weekly



SIMPLE SWITCHER 3A
Step-Down Voltage Regulator

LM2576 Series
LM2576M-XX
LM2576MK-XX
LM2576M1K-XX

Absolute Maximum Ratings (Note 1)

Minimum ESD Rating:
 LM2576, LM2576M, LM2576MK 1kV
 LM2576M1K 2kV
 (C= 100pF, R = 1.5 kΩ)
 Lead Temperature
 (Soldering, 10 Seconds) 260°C

Maximum Supply Voltage

LM2576, LM2576M,
 LM2576MK, LM2576M1K

45V

Operating Ratings

Temperature Range

ON/OFF Pin Input Voltage

$-0.3V \leq V \leq +V_{IN}$

LM2576, LM2576M,
 LM2576MK, LM2576M1K
 Supply Voltage

$-40^{\circ}C \leq T_J \leq +125^{\circ}C$

Output Voltage to Ground
 (Steady State)

-1V

LM2576, LM2576M,
 LM2576MK, LM2576M1K

40V

Power Dissipation

Internally Limited

Storage Temperature Range

$-65^{\circ}C$ to $+150^{\circ}C$

Maximum Junction Temperature

150°C

LM2576M-1.5, LM2576MK-1.5, LM2576M1K-1.5

Electrical Characteristics

Specifications with standard type face are for $T_J = 25^{\circ}C$, and those with **boldface type** apply over full Operating Temperature Range.

Symbol	Parameter	Conditions	Typ	Limit (Note 2)	Units (Limits)
SYSTEM PARAMETERS (Note 3) Test Circuit Figure 2					
V_{OUT}	Output Voltage	$V_{IN} = 12V, I_{LOAD} = 0.5A$ Circuit of Figure 2	1.5	1.470 1.530	V V(Min) V(Max)
V_{OUT}	Output Voltage	$4.2V \leq V_{IN} \leq 40V, 0.5A \leq I_{LOAD} \leq 3A$ Circuit of Figure 2	1.5	1.440/ 1.425 1.560/ 1.575	V V(Min) V(Max)



SIMPLE SWITCHER 3A Step-Down Voltage Regulator

LM2576 Series
LM2576M-XX
LM2576MK-XX
LM2576M1K-XX

LM2576M-1.8, LM2576MK-1.8, LM2576M1K-1.8

Electrical Characteristics

Specifications with standard type face are for $T_J = 25^\circ\text{C}$, and those with **boldface type** apply over full Operating Temperature Range.

Symbol	Parameter	Conditions	Typ	Limit (Note 2)	Units (Limits)
SYSTEM PARAMETERS (Note 3) Test Circuit Figure 2					
V_{OUT}	Output Voltage	$V_{IN} = 12\text{V}$, $I_{LOAD} = 0.5\text{A}$ Circuit of Figure 2	1.8	1.764 1.836	V V(Min) V(Max)
V_{OUT}	Output Voltage	$4.5\text{V} \leq V_{IN} \leq 40\text{V}$, $0.5\text{A} \leq I_{LOAD} \leq 3\text{A}$ Circuit of Figure 2	1.8	1.728/ 1.710 1.872/ 1.890	V V(Min) V(Max)

LM2576M-2.5, LM2576MK-2.5, LM2576M1K-2.5

Electrical Characteristics

Specifications with standard type face are for $T_J = 25^\circ\text{C}$, and those with **boldface type** apply over full Operating Temperature Range.

Symbol	Parameter	Conditions	Typ	Limit (Note 2)	Units (Limits)
SYSTEM PARAMETERS (Note 3) Test Circuit Figure 2					
V_{OUT}	Output Voltage	$V_{IN} = 12\text{V}$, $I_{LOAD} = 0.5\text{A}$ Circuit of Figure 2	2.5	2.450 2.550	V V(Min) V(Max)
V_{OUT}	Output Voltage	$5.2\text{V} \leq V_{IN} \leq 40\text{V}$, $0.5\text{A} \leq I_{LOAD} \leq 3\text{A}$ Circuit of Figure 2	2.5	2.400/ 2.375 2.600/ 2.625	V V(Min) V(Max)



SIMPLE SWITCHER 3A Step-Down Voltage Regulator

LM2576 Series
LM2576M-XX
LM2576MK-XX
LM2576M1K-XX

LM2576-3.3, LM2576M-3.3, LM2576MK-3.3 LM2576M1K-3.3

Electrical Characteristics

Specifications with standard type face are for $T_J = 25^\circ\text{C}$, and those with **boldface type** apply over full Operating Temperature Range.

Symbol	Parameter	Conditions	Typ	Limit (Note 2)	Units (Limits)
SYSTEM PARAMETERS (Note 3) Test Circuit Figure 2					
V_{OUT}	Output Voltage	$V_{\text{IN}} = 12\text{V}$, $I_{\text{LOAD}} = 0.5\text{A}$ Circuit of Figure 2	3.3	3.234 3.366	V V(Min) V(Max)
V_{OUT}	Output Voltage	$6\text{V} \leq V_{\text{IN}} \leq 40\text{V}$, $0.5\text{A} \leq I_{\text{LOAD}} \leq 3\text{A}$ Circuit of Figure 2	3.3	3.168/ 3.135 3.432/ 3.465	V V(Min) V(Max)
η	Efficiency	$V_{\text{IN}} = 12\text{V}$, $I_{\text{LOAD}} = 3\text{A}$	75		%

LM2576-5.0, LM2576M-5.0, LM2576MK-5.0, LM2576M1K-5.0

Electrical Characteristics

Specifications with standard type face are for $T_J = 25^\circ\text{C}$, and those with **Figure 2 boldface type** apply over full Operating Temperature Range.

Symbol	Parameter	Conditions	Typ	Limit (Note 2)	Units (Limits)
SYSTEM PARAMETERS (Note 3) Test Circuit Figure 2					
V_{OUT}	Output Voltage	$V_{\text{IN}} = 12\text{V}$, $I_{\text{LOAD}} = 0.5\text{A}$ Circuit of Figure 2	5.0	4.900 5.100	V V(Min) V(Max)
V_{OUT}	Output Voltage	$0.5\text{A} \leq I_{\text{LOAD}} \leq 3\text{A}$, $8\text{V} \leq V_{\text{IN}} \leq 40\text{V}$ Circuit of Figure 2	5.0	4.800/ 4.750 5.200/ 5.250	V V(Min) V(Max)
η	Efficiency	$V_{\text{IN}} = 12\text{V}$, $I_{\text{LOAD}} = 3\text{A}$	77		%



**SIMPLE SWITCHER 3A
Step-Down Voltage Regulator**

**LM2576 Series
LM2576M-XX
LM2576MK-XX
LM2576M1K-XX**

LM2576-12, LM2576M-12, LM2576MK-12, LM2576M1K-12

Electrical Characteristics

Specifications with standard type face are for $T_J = 25^\circ\text{C}$, and those with **boldface type** apply over full Operating Temperature Range.

Symbol	Parameter	Conditions	Typ	Limit (Note 2)	Units (Limits)
SYSTEM PARAMETERS (Note 3) Test Circuit Figure 2					
V_{OUT}	Output Voltage	$V_{IN} = 25\text{V}$, $I_{LOAD} = 0.5\text{A}$ Circuit of Figure 2	12	11.76 12.24	V V(Min) V(Max)
V_{OUT}	Output Voltage	$0.5\text{A} \leq I_{LOAD} \leq 3\text{A}$, $15\text{V} \leq V_{IN} \leq 40\text{V}$ Circuit of Figure 2	12	11.52/ 11.40 12.48/ 12.60	V V(Min) V(Max)
η	Efficiency	$V_{IN} = 15\text{V}$, $I_{LOAD} = 3\text{A}$	88		%

LM2576-15, LM2576M-15, LM2576MK-15, LM2576M1K-15

Electrical Characteristics

Specifications with standard type face are for $T_J = 25^\circ\text{C}$, and those with **boldface type** apply over full Operating Temperature Range.

Symbol	Parameter	Conditions	Typ	Limit (Note 2)	Units (Limits)
SYSTEM PARAMETERS (Note 3) Test Circuit Figure 2					
V_{OUT}	Output Voltage	$V_{IN} = 25\text{V}$, $I_{LOAD} = 0.5\text{A}$ Circuit of Figure 2	15	14.70 15.30	V V(Min) V(Max)
V_{OUT}	Output Voltage	$0.5\text{A} \leq I_{LOAD} \leq 3\text{A}$, $18\text{V} \leq V_{IN} \leq 40\text{V}$ Circuit of Figure 2	15	14.40/ 14.25 15.60/ 15.75	V V(Min) V(Max)
η	Efficiency	$V_{IN} = 18\text{V}$, $I_{LOAD} = 3\text{A}$	88		%

LM2576-ADJ, LM2576M-ADJ, LM2576MK-ADJ, LM2576M1K-ADJ

Electrical Characteristics

Specifications with standard type face are for $T_J = 25^\circ\text{C}$, and those with **boldface type** apply over full Operating Temperature Range.

Symbol	Parameter	Conditions	Typ	Limit (Note 2)	Units (Limits)
SYSTEM PARAMETERS (Note 3) Test Circuit Figure 2					
V_{OUT}	Feedback Voltage	$V_{IN} = 12\text{V}$, $I_{LOAD} = 0.5\text{A}$, $V_{OUT} = 5\text{V}$ Circuit of Figure 2	1.230	1.217 1.243	V V(Min) V(Max)
V_{OUT}	Feedback Voltage	$0.5\text{A} \leq I_{LOAD} \leq 3\text{A}$, $8\text{V} \leq V_{IN} \leq 40\text{V}$ $V_{OUT} = 5\text{V}$ Circuit of Figure 2	1.230	1.193/ 1.180 1.267/ 1.280	V V(Min) V(Max)
η	Efficiency	$V_{IN} = 12\text{V}$, $I_{LOAD} = 3\text{A}$, $V_{OUT} = 5\text{V}$	77		%



All Output Voltage Versions
Electrical Characteristics

Specifications with standard type face are for $T_J = 25^\circ\text{C}$, and those with **boldface type** apply over full Operating Temperature Range. Unless otherwise specified, $V_{IN} = 12\text{V}$ for the 3.3V, 5V, and Adjustable version, $V_{IN} = 25\text{V}$ for the 12V version, and $V_{IN} = 30\text{V}$ for the 15V version, , $I_{LOAD} = 500\text{mA}$.

Symbol	Parameter	Conditions	LM2576-XX LM2576M-XX LM2576MK-XX LM2576M1K-XX		Units (Limits)
			Typ	Limit (Note 2)	
DEVICE PARAMETERS					
I_b	Feedback Bias Current	$V_{OUT} = 5\text{V}$ (Adjustable Version Only)	50	100/ 500	nA
f_o	Oscillator Frequency	(Note 8)	52	47/ 42 58/ 63	kHz kHz (Min) kHz (Max)
V_{SAT}	Saturation Voltage	$I_{OUT} = 3\text{A}$ (Note 4)	1.4	1.8/ 2.0	V V(Max)
DC	Max Duty Cycle (ON)	(Note 5)	98	93	% %(Min)
I_{CL}	Current Limit	(Notes 4, 8)	5.8	4.2/ 3.5 6.9/ 7.5	A A(Min) A(Max)
I_L	Output Leakage Current	(Notes 6, 7): Output = 0V Output = -1V Output = -1V	7.5	2 30	mA(Max) mA mA(Max)
I_Q	Quiescent Current	(Note 6)	5	10	mA mA(Max)
I_{STBY}	Standby Quiescent Current	$\overline{\text{ON/OFF}}$ Pin = 5V (OFF)	50	200	μA $\mu\text{A}(\text{Max})$

All Output Voltage Versions

Electrical Characteristics (Continued)

Specifications with standard type face are for $T_J = 25^\circ\text{C}$, and those with **boldface type** apply over full Operating Temperature Range. Unless otherwise specified, $V_{IN} = 12\text{V}$ for the 3.3V, 5V, and Adjustable version, $V_{IN} = 25\text{V}$ for the 12V version, and $V_{IN} = 30\text{V}$ for the 15V version, $I_{LOAD} = 500\text{mA}$.

Symbol	Parameter	Conditions	LM2576-XX LM2576M-XX LM2576MK-XX LM2576M1K-XX		Units (Limits)
			Typ	Limit (Note 2)	
ON/OFF CONTROL					
V_{IH}	$\overline{\text{ON/OFF}}$ Pin	$V_{OUT} = 0\text{V}$	1.4	2.2/ 2.4	V(Min)
V_{IL}	Logic Input Level	$V_{OUT} = \text{Nominal Output Voltage}$	1.2	1.0/ 0.8	V(Max)
I_{IH}	$\overline{\text{ON/OFF}}$ Pin Input Current	$\overline{\text{ON/OFF}}$ Pin = 5V (OFF)	12	30	μA $\mu\text{A}(\text{Max})$
I_{IL}		$\overline{\text{ON/OFF}}$ Pin = 0V (ON)	0	10	μA $\mu\text{A}(\text{Max})$

Note 1: Absolute Maximum Ratings indicate limits beyond which damage to the device may occur. Operating Ratings indicate conditions for which the device is intended to be functional, but do not guarantee specific performance limits. For guaranteed specifications and test conditions, see the Electrical Characteristics.

Note 2: All limits guaranteed at room temperature (standard type face) and at temperature extremes (bold type face).

Note 3: External components such as the catch diode, inductor, input and output capacitors can affect switching regulator system performance. When the LM2576, LM2576M, LM2576MK, LM2576M1K is used as shown in the *Figure 2* test circuit, system performance will be as shown in system parameters section of Electrical Characteristics.

Note 4: Output pin sourcing current. No diode, inductor or capacitor connected to output.

Note 5: Feedback pin removed from output and connected to 0V.

Note 6: Feedback pin removed from output and connected to +12V for the Adjustable, 3.3V, and 5V, versions, and +25V for the 12V and 15V versions, to force the output transistor OFF.

Note 7: $V_{IN} = 40\text{V}$.

Note 8: The oscillator frequency reduces to approximately 11 kHz in the event of an output short or an overload which causes the regulated output voltage to drop approximately 40% from the nominal output voltage. This self protection feature lowers the average power dissipation of the IC by lowering the minimum duty cycle from 5% down to approximately 2%.

Typical Performance Characteristics (Circuit of Figure 2)

Normalized Output Voltage

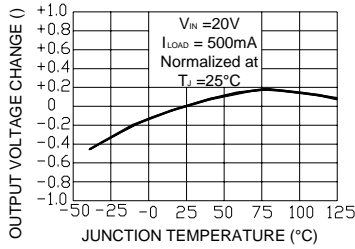

Line Regulation

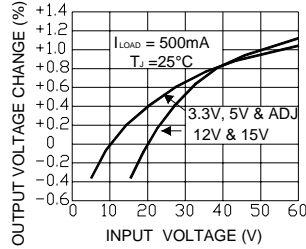

Dropout Voltage

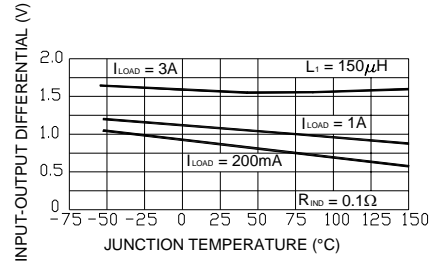

Standby Quiescent Current

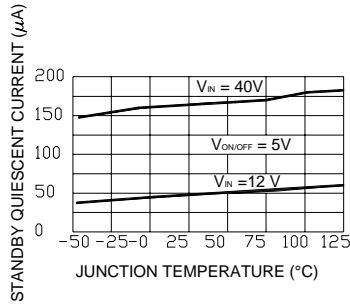

Quiescent Current

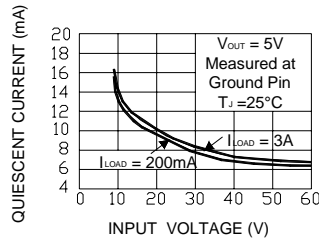

Current Limit

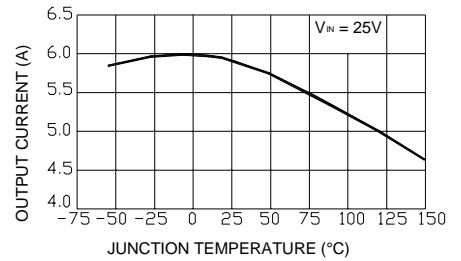

Switch Saturation Voltage

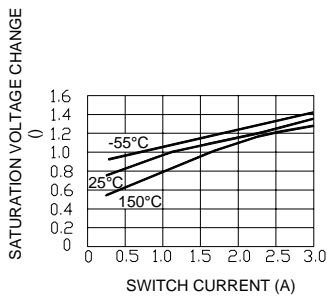

Efficiency

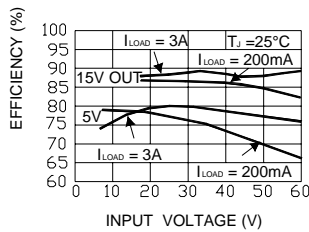

Oscillator Frequency

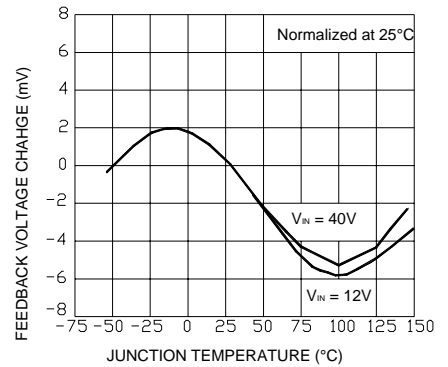

Typical Performance Characteristics (Circuit of *Figure 2*) (Continued)

Minimum Operating Voltage

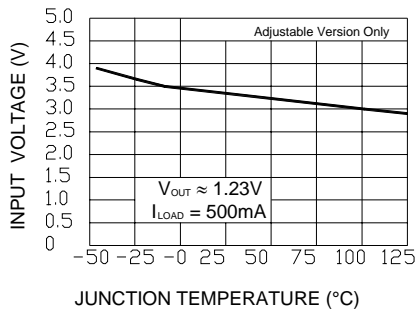

Quiescent Current vs Duty Cycle

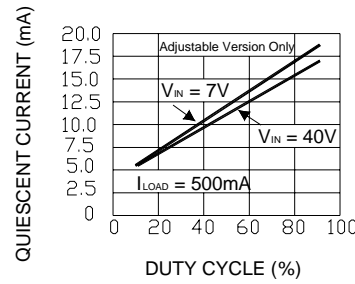

Feedback Voltage vs Duty Cycle

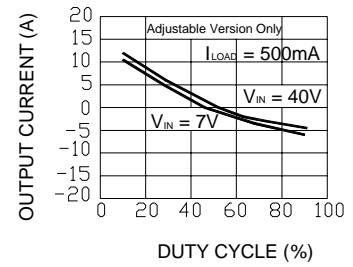

Maximum Power Dissipation (TO-263)

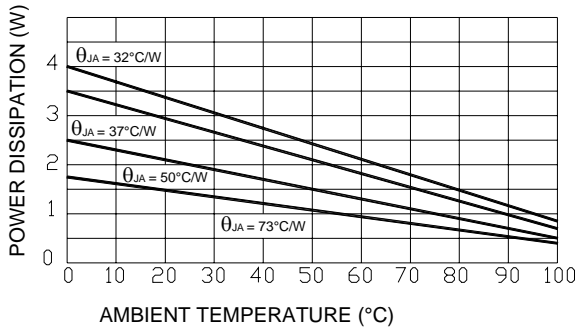

Feedback Pin Current

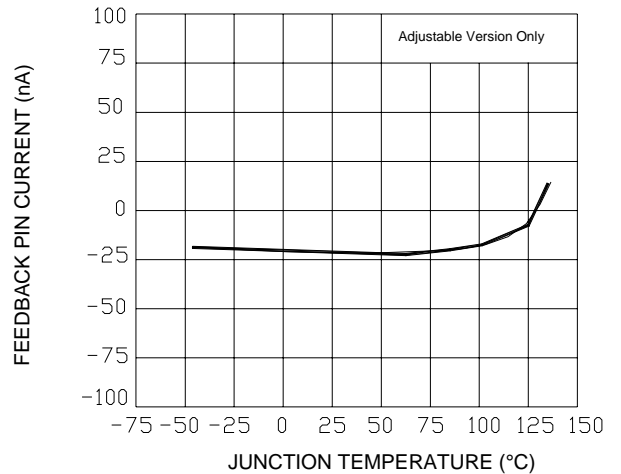

Typical Performance Characteristics (Circuit of *Figure 2*) (Continued)

Switching Waveforms

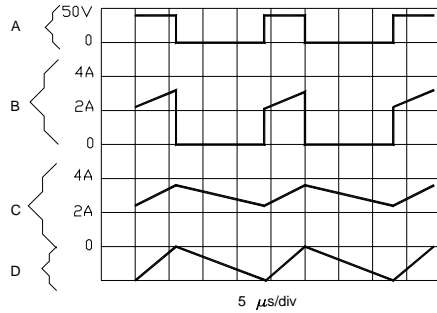

Load Transient Response

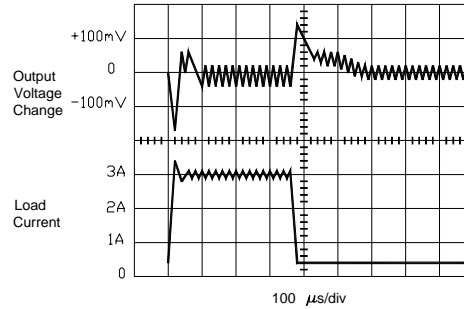

$V_{OUT} = 15V$

A: Output Pin Voltage, 50V/div

B: Output Pin Current, 2A/div

C: Inductor Current, 2A/div

D: Output Ripple Voltage, 50mV/div,

AC-Coupled

Horizontal Time Base: 5μs/div

Test Circuit and Layout Guidelines

As in any switching regulator, layout is very important. Rapidly switching currents associated with wiring inductance generate voltage transients which can cause problems. For minimal inductance and ground loops, the length of the leads indicated by heavy lines should be kept as short as possible.

Single-point grounding (as indicated) or ground plane construction should be used for best results. When using the Adjustable version, physically locate the programming resistors near the regulator, to keep the sensitive feedback wiring short.

Fixed Output Voltage Versions

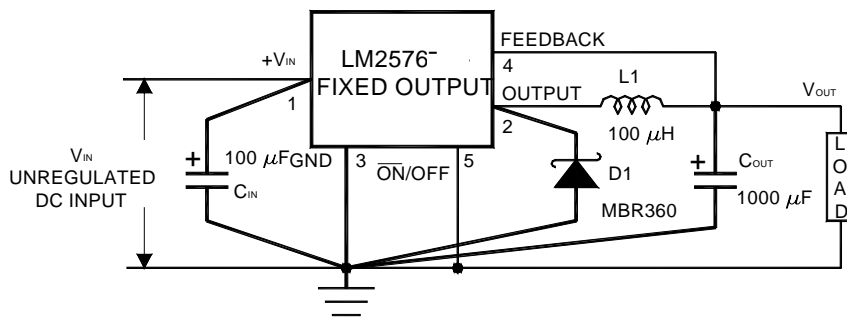

- C_{IN} — 100µF, 75V, Aluminum Electrolytic
- C_{OUT} — 1000µF, 25V, Aluminum Electrolytic
- D1 — Schottky, MBR360
- L1 — 100µH, Pulse Eng. PE-92108
- R₁ — 2k, 0.1%
- R₂ — 6.12k, 0.1%

Adjustable Output Voltage Version

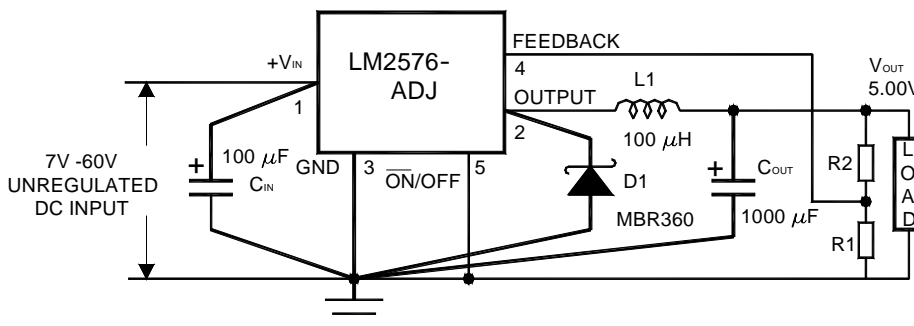

$$V_{OUT} = V_{REF} \left(1 + \frac{R_2}{R_1} \right)$$

$$R_2 = R_1 \left(\frac{V_{OUT}}{V_{REF}} - 1 \right)$$

where V_{REF} = 1.23V, R₁ between 1k and 5k

FIGURE 2.