



LCD-Monitor

Chassis LS17DOA
 LS19DOA

Model 741MP
 941MP

SERVICE Manual

LCD Monitor



Fashion Feature

- All - in - One Chip

Copyright

©2006 by Samsung Electronics Co., Ltd.

All rights reserved.

This manual may not, in whole or in part, be copied, photocopied, reproduced, translated, or converted to any electronic or machine readable form without prior written permission of Samsung Electronics Co., Ltd.

LS17DOA, LS19DOA Service Manual

First edition July 2006.

Printed in Korea.

Trademarks

Samsung is the registered trademark of Samsung Electronics Co., Ltd.

LS17DOA, LS19DOA and MacMaster Cable Adapter are trademarks of Samsung Electronics Co., Ltd.

Macintosh, Power Macintosh are trademarks of Apple Computer, Inc.

All other trademarks are the property of their respective owners.

Contents

1. Precautions	1-1
1-1. Safety Precautions	1-1
1-2. Servicing Precautions	1-2
1-3. Static Electricity Precautions	1-2
1-4. Install Precautions	1-2
2. Product specifications	2-1
2-1. Fashion Feature	2-1
2-2. Specifications Comparison to the Old Model	2-1
2-3. LS17DOA Specifications	2-2
2-3. LS19DOA Specifications	2-3
2-4. Option Specification	2-4
3. Alignments and Adjustments	3-1
3-1. EDID input method	3-1
3-2. DDC JIG Installation	3-2
3-3. EDID Installation with Windows Program	3-3
3-4. Factory Mode Adjustments	3-4
4. Troubleshooting	4-1
4-1. No Power	4-1
4-2. No Picture (PC Signal)	4-2
4-3. No Picture (TV)	4-4
4-4. No Picture (Video/S-Video/Scart)	4-6
4-5. No Picture (Component)	4-8
4-6. No Sound (TV)	4-10
4-7. No Sound (Component)	4-12
5. Exploded View and Parts List	5-1
5-1. Exploded View	5-1
5-2. Parts List	5-2
6. Electrical Parts List	6-1
6-1 LS19DOW Parts List	6-1
7. Block Diagram	7-1

Contents

8. Wiring Diagram	8-1
9. Schematic Diagrams	9-1
10. Operating Instructions and Installation	10-1
10-1. Front	10-1
10-2. Rear	10-2
10-3. Remote Control	10-5
11. Disassembly and Reassembly	11-1
11-1. Disassembly	11-1
11-3. Reassembly	11-3
12. PCB Diagram	12-1
13. Circuit Descriptions	13-1
13-1. Block description	13-1
14. Reference Information	14-1
14-1. Technical Terms	14-1
14-2. Connecting Your Monitor	14-4
14-3. Connecting to Others devices	14-5
14-4. Pin Assignment	14-7
14-5. Timing Chart	14-9
14-6. Preset Timing Modes	14-10
14-7. Panel Description	14-11



-This Service Manual is a property of Samsung Electronics Co., Ltd.
Any unauthorized use of Manual can be punished under applicable International and/or domestic law.

Samsung Electronics Co.,Ltd.
416, Maetan-3Dong, Yeongtong-Gu, Suwon City,
Gyeonggi-Do, Korea, 443-742
Printed in Korea
P/N : BN82-00125D-00
URL : <http://itself.sec.samsung.co.kr/>

1 Precautions

Follow these safety, servicing and ESD precautions to prevent damage and to protect against potential hazards such as electrical shock.

1-1 Safety Precautions

1-1-1 Warnings

1. For continued safety, do not attempt to modify the circuit board.
2. Disconnect the AC power and DC power jack before servicing.

1-1-2 Servicing the LCD Monitor

1. When servicing the LCD Monitor, Disconnect the AC line cord from the AC outlet.
2. It is essential that service technicians have an accurate voltage meter available at all times. Check the calibration of this meter periodically.

1-1-3 Fire and Shock Hazard

Before returning the monitor to the user, perform the following safety checks:

1. Inspect each lead dress to make certain that the leads are not pinched or that hardware is not lodged between the chassis and other metal parts in the monitor.
2. Inspect all protective devices such as nonmetallic control knobs, insulating materials, cabinet backs, adjustment and compartment covers or shields, isolation resistor-capacitor networks, mechanical insulators, etc.
3. Leakage Current Hot Check (Figure 1-1):

WARNING : Do not use an isolation transformer during this test.

Use a leakage current tester or a metering system that complies with American National Standards Institute (*ANSI C101.1, Leakage Current for Appliances*), and Underwriters Laboratories (*UL Publication UL1410, 59.7*).

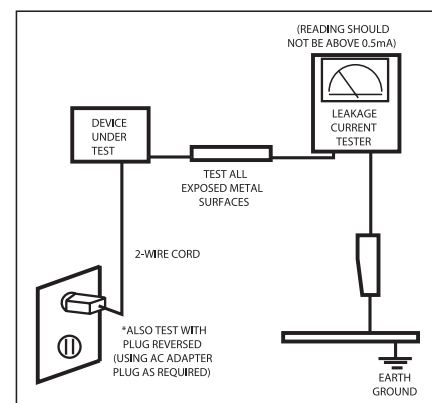

Figure 1-1. Leakage Current Test Circuit

4. With the unit completely reassembled, plug the AC line cord directly into a 120V AC outlet. With the unit's AC switch first in the ON position and then OFF, measure the current between a known earth ground (metal water pipe, conduit, etc.) and all exposed metal parts, including: metal cabinets, screwheads and control shafts. The current measured should not exceed 0.5 milliamp. Reverse the power-plug prongs in the AC outlet and repeat the test.

1-1-4 Product Safety Notices

Some electrical and mechanical parts have special safety-related characteristics which are often not evident from visual inspection. The protection they give may not be obtained by replacing them with components rated for higher voltage, wattage, etc. Parts that have special safety characteristics are identified by \triangle on schematics and parts lists. A substitute replacement that does not have the same safety characteristics as the recommended replacement part might create shock, fire and/or other hazards. Product safety is under review continuously and new instructions are issued whenever appropriate.

1 Precautions

1-2 Servicing Precautions

WARNING: An electrolytic capacitor installed with the wrong polarity might explode.

Caution: Before servicing units covered by this service manual, read and follow the Safety Precautions section of this manual.

Note: If unforeseen circumstances create conflict between the following servicing precautions and any of the safety precautions, always follow the safety precautions.

1-2-1 General Servicing Precautions

1. Always unplug the unit's AC power cord from the AC power source and disconnect the DC Power Jack before attempting to:
 - (a) remove or reinstall any component or assembly, (b) disconnect PCB plugs or connectors, (c) connect a test component in parallel with an electrolytic capacitor.
2. Some components are raised above the printed circuit board for safety. An insulation tube or tape is sometimes used. The internal wiring is sometimes clamped to prevent contact with thermally hot components. Reinstall all such elements to their original position.
3. After servicing, always check that the screws, components and wiring have been correctly reinstalled. Make sure that the area around the serviced part has not been damaged.
4. Check the insulation between the blades of the AC plug and accessible conductive parts (examples: metal panels, input terminals and earphone jacks).
5. Insulation Checking Procedure: Disconnect the power cord from the AC source and turn the power switch ON. Connect an insulation resistance meter (500 V) to the blades of the AC plug.

The insulation resistance between each blade of the AC plug and accessible conductive parts (see above) should be greater than 1 megohm.
6. Always connect a test instrument's ground lead to the instrument chassis ground before connecting the positive lead; always remove the instrument's ground lead last.

1-3 Static Electricity Precautions

Some semiconductor (solid state) devices can be easily damaged by static electricity. Such components are commonly called Electrostatically Sensitive Devices (ESD). Examples of typical ESD are integrated circuits and some field-effect transistors. The following techniques will reduce the incidence of component damage caused by static electricity.

1. Immediately before handling any semiconductor components or assemblies, drain the electrostatic charge from your body by touching a known earth ground. Alternatively, wear a discharging wrist-strap device. To avoid a shock hazard, be sure to remove the wrist strap before applying power to the monitor.
2. After removing an ESD-equipped assembly, place it on a conductive surface such as aluminum foil to prevent accumulation of an electrostatic charge.
3. Do not use freon-propelled chemicals. These can generate electrical charges sufficient to damage ESDs.
4. Use only a grounded-tip soldering iron to solder or desolder ESDs.
5. Use only an anti-static solder removal device. Some solder removal devices not classified as "anti-static" can generate electrical charges sufficient to damage ESDs.
6. Do not remove a replacement ESD from its protective package until you are ready to install it. Most replacement ESDs are packaged with leads that are electrically shorted together by conductive foam, aluminum foil or other conductive materials.
7. Immediately before removing the protective material from the leads of a replacement ESD, touch the protective material to the chassis or circuit assembly into which the device will be installed.

Caution: Be sure no power is applied to the chassis or circuit and observe all other safety precautions.
8. Minimize body motions when handling unpackaged replacement ESDs. Motions such as brushing clothes together, or lifting your foot from a carpeted floor can generate enough static electricity to damage an ESD.

1-4 Installation Precautions

1. For safety reasons, more than two people are required for carrying the product.
2. Keep the power cord away from any heat emitting devices, as a melted covering may cause fire or electric shock.
3. Do not place the product in areas with poor ventilation such as a bookshelf or closet. The increased internal temperature may cause fire.
4. Bend the external antenna cable when connecting it to the product. This is a measure to protect it from being exposed to moisture. Otherwise, it may cause a fire or electric shock.
5. Make sure to turn the power off and unplug the power cord from the outlet before repositioning the product. Also check the antenna cable or the external connectors if they are fully unplugged. Damage to the cord may cause fire or electric shock.
6. Keep the antenna far away from any high-voltage cables and install it firmly. Contact with the high-voltage cable or the antenna falling over may cause fire or electric shock.
7. When installing the product, leave enough space (10cm) between the product and the wall for ventilation purposes. A rise in temperature within the product may cause fire.

1 Precautions



Memo

2 Product Specifications

2-1 Fashion Feature

- MFM Model
- VCT49xy
- W/W model
- High Contrast Ratio(700:1)
- High Luminance(300cd/m2)

2-2 Specifications Comparison to the Old Model

Model	LDO19WS	LS17DOA, LS19DOA
Area	World Wide Asia	China / East-South
Panel	LTM190M2-L01	EX-L21
Response Time	8ms	8ms
Scart Jack	O	O
Micom	VCT49xy (Embedded MCU)	SE967-LF
Scaler	SE6181	SE967-LF
PBA		

2 Product Specifications

2-3 LS17DOA Specifications







Item	Description
LCD Panel	TFT-LCD panel, RGB vertical stripe, normally white, 17-Inch viewable, 0.264mm pixel pitch
Scanning Frequency	31 kHz ~ 81 kHz(Automatic)
Display Colors	16.7 Million colors
Maximum Resolution	Horizontal:1280 Pixels Vertical : 1024 Pixels
Input Video Signal	Analog, 0.7 Vp-p \pm 1% positive at 75 Ω , internally terminated, DVI
Input Sync Signal	Type: Seperate H/V automatic synchronization without external switch of sync type, Composite Level: TTL level
Maximum Pixel Clock rate	135 MHz
Active Display Horizontal/Vertical	337.92 mm (H) x 270.336 mm (V)
AC power voltage & Frequency	AC 100 ~ 240 Volts (\pm 10%), 60/ 50 Hz \pm 3 Hz
Power Consumption	49 W (max)
Dimensions Set (W x H x D)	15.0 x 2.1 x 15.5 inch (380 x 53 x 394.2 mm)
Weight (Set/Package)	4.0 kg (8.8 lbs)
TV / Video	Color system : NTSC, PAL, SAM, PAL-M/N, NT43, PAL60
	Sound system : B/G, I, D/K
Antena Input	75 Ω , Coaxial Cable
Environmental Considerations	Operating Temperature : 50°F ~ 104°F (10°C ~ 40°C) Operating Humidity : 10 % ~ 80 % Storage Temperature : -4°F ~ 113°F (-20°C ~ 45°C) Storage Humidity : 5 % ~ 95 %
<ul style="list-style-type: none"> • Designs and specifications are subject to change without prior notice. 	

2-4 LS19DOA Specifications

Item	Description
LCD Panel	TFT-LCD panel, RGB vertical stripe, normally white, 19-Inch viewable, 0.194mm pixel pitch
Scanning Frequency	31 kHz ~ 81 kHz(Automatic)
Display Colors	16.7 Million colors
Maximum Resolution	Horizontal:1280 Pixels Vertical: 1024 Pixels
Input Video Signal	Analog, 0.7 Vp-p \pm 1% positive at 75 Ω , internally terminated, DVI
Input Sync Signal	Type: Seperate H/V automatic synchronization without external switch of sync type, Composite Level: TTL level
Maximum Pixel Clock rate	135 MHz
Active Display Horizontal/Vertical	376.32 mm (H) x 301.056 mm (V)
AC power voltage & Frequency	AC 100 ~ 240 Volts (\pm 10%), 60/ 50 Hz \pm 3 Hz
Power Consumption	19 W (max)
Dimensions Set (W x H x D)	16.5 x 8.5 x 17.0 inch (420 x 217 x 433 mm)
Weight (Set/Package)	6.2 kg (14 lbs)
TV / Video	Color system : NTSC, PAL, SAM, PAL-M/N, NT43, PAL60
	Sound system : B/G, I, D/K
Antena Input	75 Ω , Coaxial Cable
Environmental Considerations	Operating Temperature : 50°F ~ 104°F (10°C ~ 40°C) Operating Humidity : 10 % ~ 80 % Storage Temperature : -4°F ~ 113°F (-20°C ~ 45°C) Storage Humidity : 5 % ~ 95 %
<ul style="list-style-type: none"> • Designs and specifications are subject to change without prior notice. 	

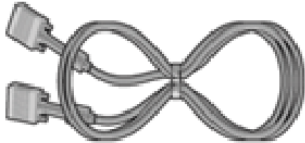
2 Product Specifications

2-4 Option Specification

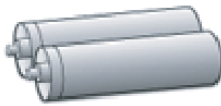
Item	Item Name	CODE.NO	Remark
	Quick Setup Guide	BN68-01071A	
	Warranty Card (Not available in all locations)	BH68-70438A	
	User's Guide, Monitor Driver, Natural Color software	BN59-00566A	
	D-Sub(15 Pin) Cable	BN39-00244B	
	Audio Cable	BN39-00061B	
	Power Cord	3903-000042	
	Remote Control	BN59-00434C	
	Batteries (AAA X 2)	4301-000121	

3 Alignments and Adjustments

3-1 EDID input method

SAMSUNG MFM support the DDC control JIG.

You can see the connection between PC and MFM.

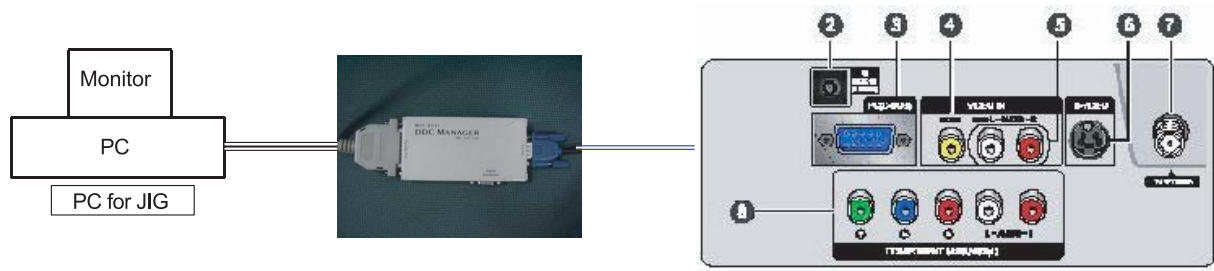

3 Alignments and Adjustments

3-2 EDID Installation with Dos Program



1. Execute "DDC21.exe"±

2. Click "LOAD FILE"±

3. Input the File Name
- ".ddc"

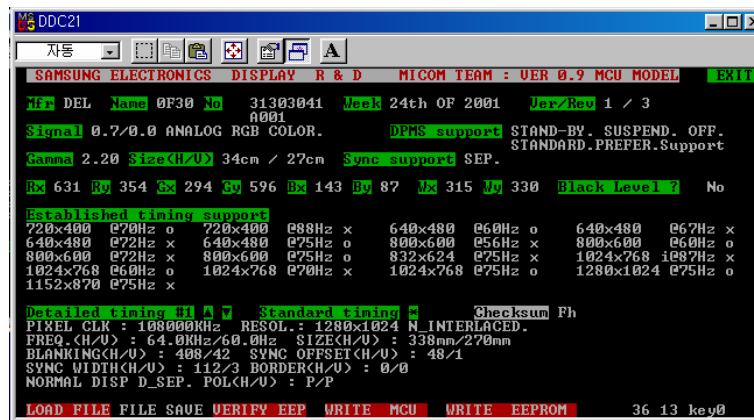

4. Click "WRITE EEPROM"±

Confirm the "OK" Sign

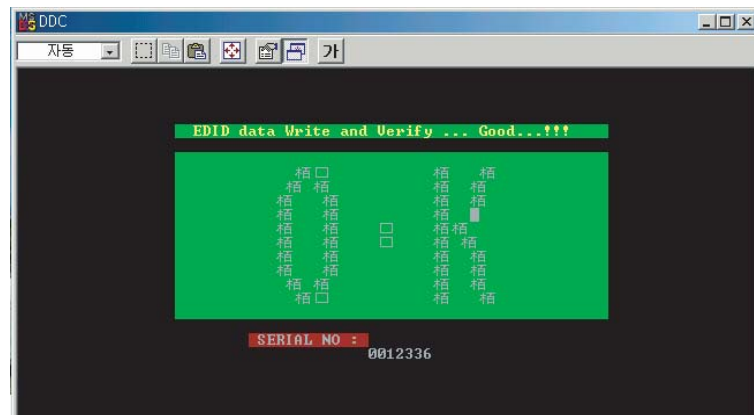

Error Message: Check the Signal Cable
or Interface Board

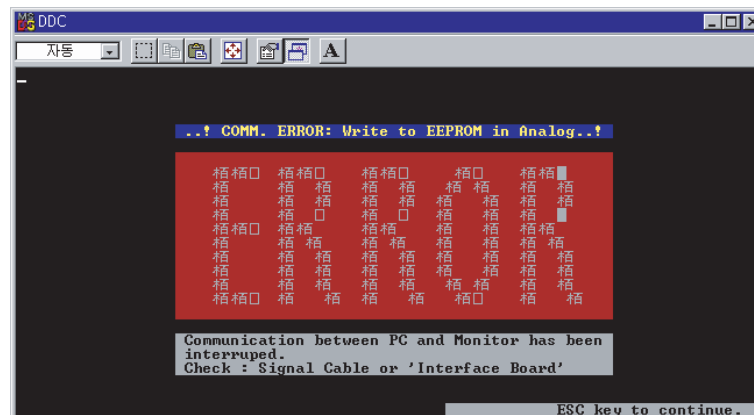

3-3 EDID Installation with Windows Program

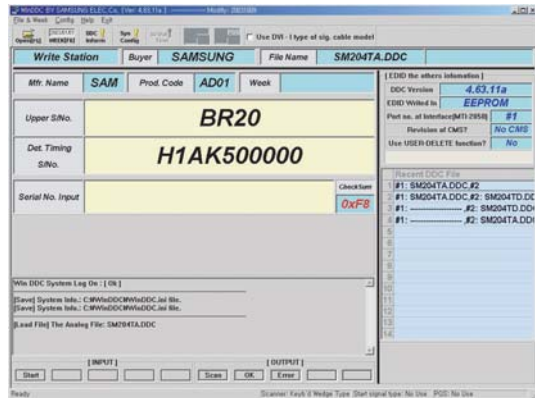

1. Execute "WinDDC.exe"

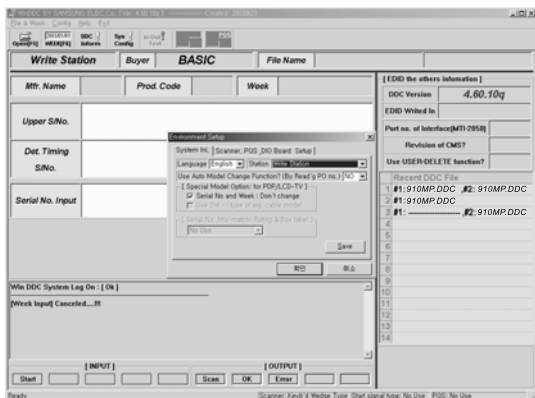

2. Click "Sys Config"
 Select "Station : Write station"
 Check "Serial No and Week : Don't change"
 Click "Save"

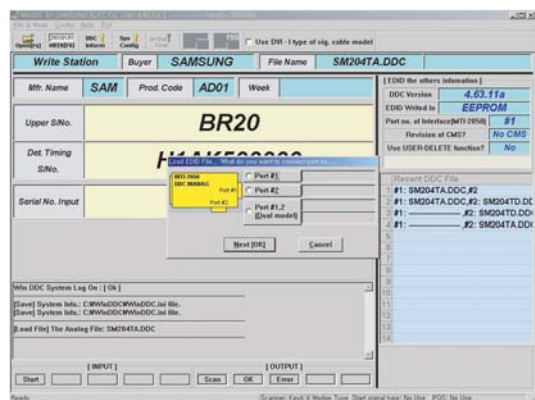

3. Click "Open" icon.
 Select "Connected Port #1" and Next "OK".
 * File Name - 741MP.DDC : Analog
 - 941MP.DDC : Digital
 Press enter key on your keyboard.

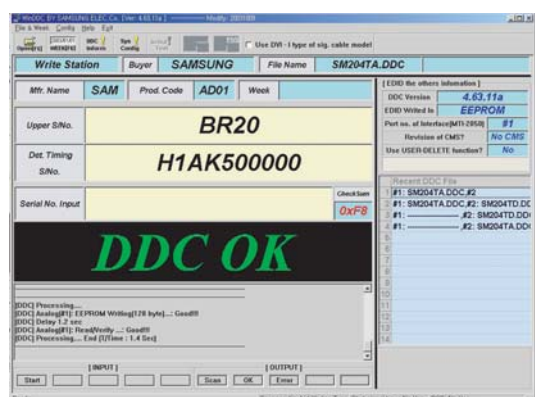

4. Confirm the "DDC OK".

- After Replacing the Main Board
- EDID Installation (Analog and Digital)

3 Alignments and Adjustments

3-4 Code Update

1. Install the winDDC_V2-16_02 Program

2. Run the winDDC program

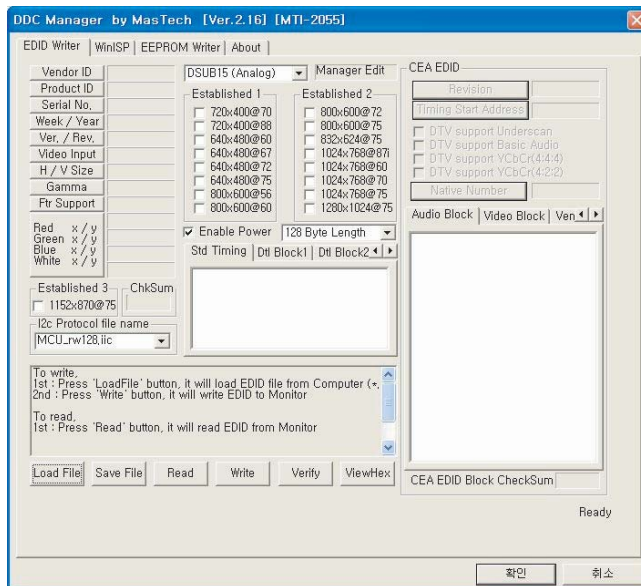

Run the DDC Manager program Initial screen

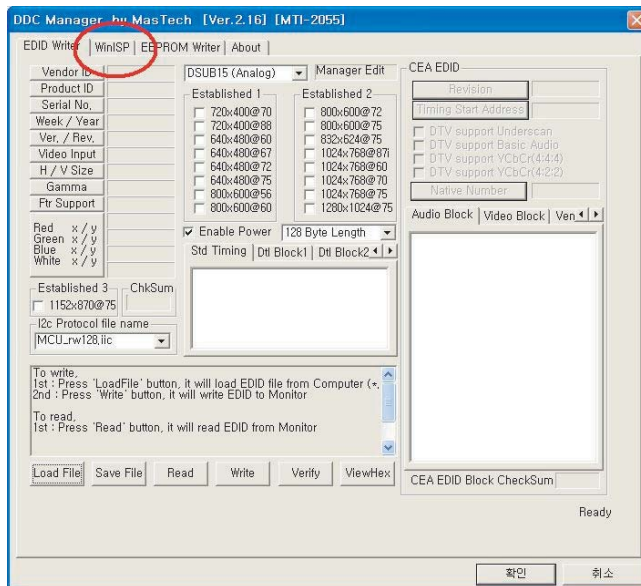

Select the WinISP

3 Alignments and Adjustments

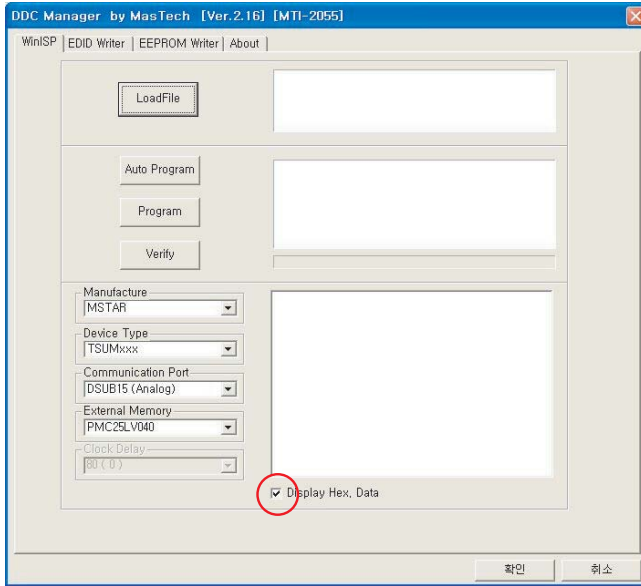

Select the LoadFile

Ignore the checking for the Display Hex.Data

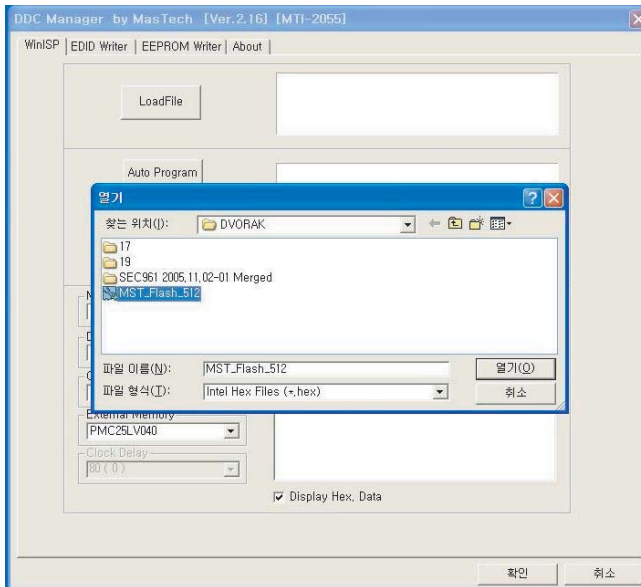

Select a code to be updated

Only the *.hex file can be downloaded

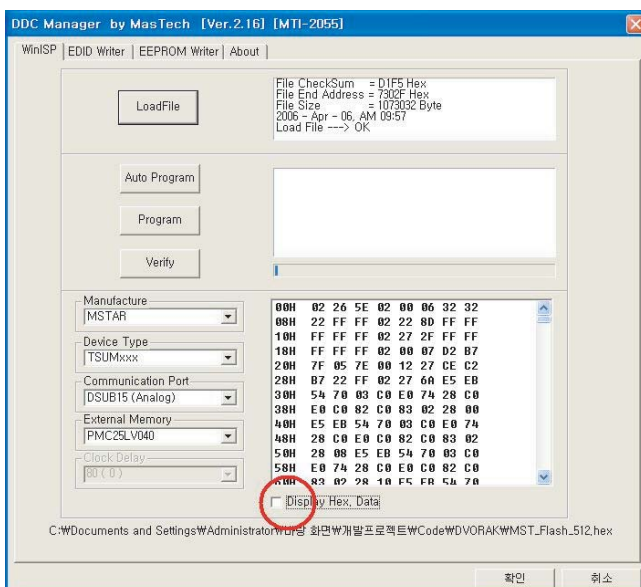

Load File Confirm 'OK'

3 Alignments and Adjustments

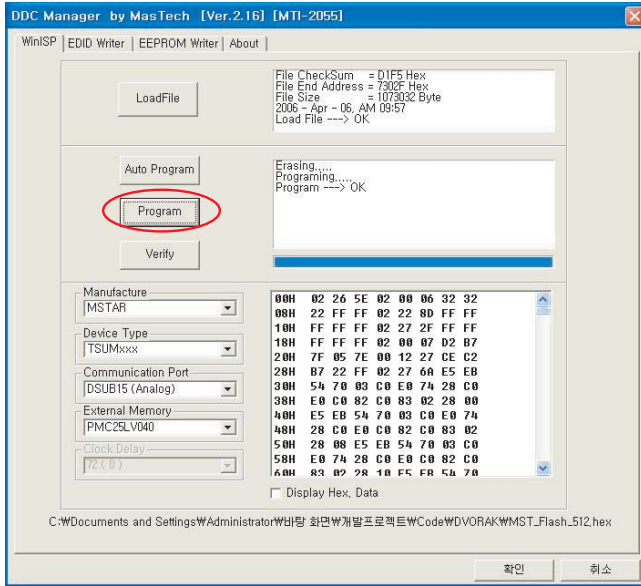

Select the Program

Code Update Erasing Programming

Confirm 'OK'

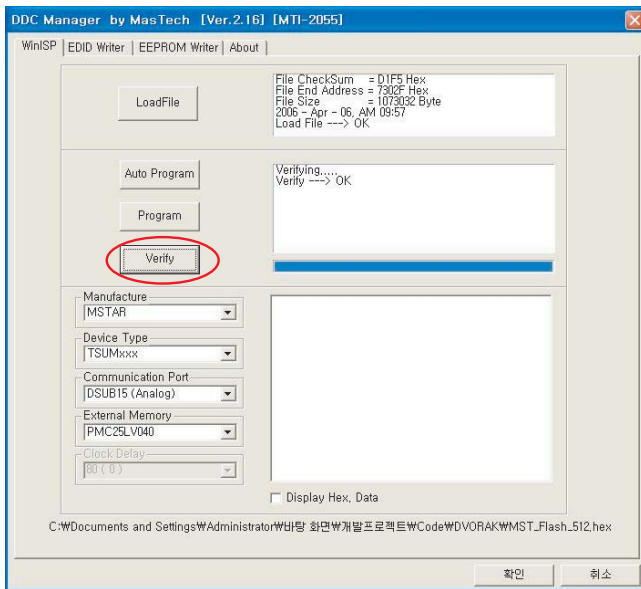

Select the Verify Confirm 'OK'

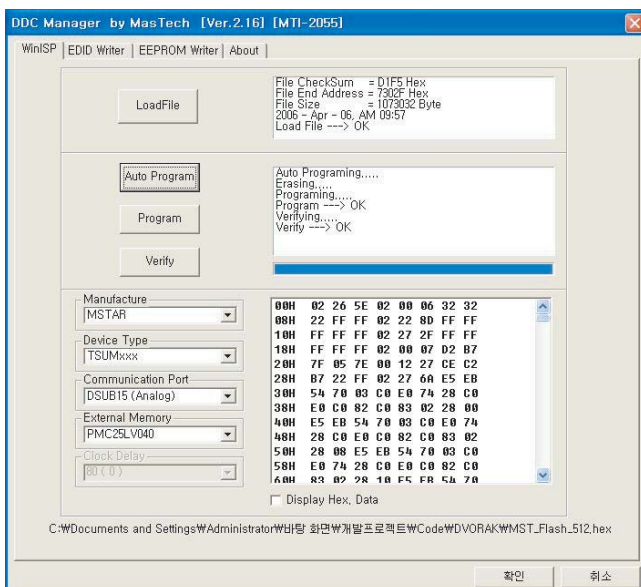

When selecting the Auto Program

It performs the Erasing, Programming, and Verifying all together.

3-5 Factory Mode Adjustments

3-5-1 Factory Mode Admission

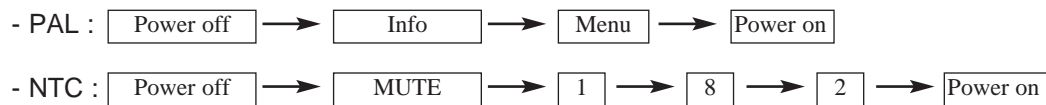

3-5-2 Service Function list

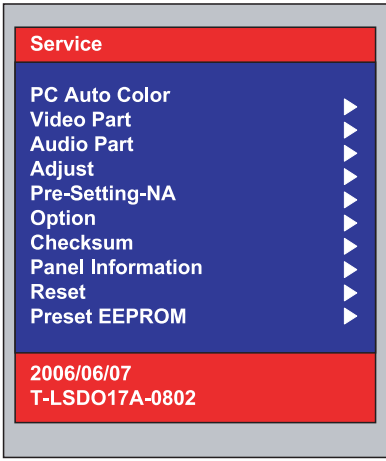
No	Function	Action method
1.	Hidden Service Function 	<p>Entering Factory Mode</p> <p>1) To enter "Service Mode" Press the remote -control keys in this sequence :</p> <p>- If you do not have Factory remote - control POWER OFF -> INFO -> MENU -> MUTE -> POWER ON</p> <p>2) If you have Factory remote-control POWER ON -> INFO -> Factory</p> <p>- . OSD which the basic adjustment is added.</p> <p>PC Auto Color Video Part Audio Part Adjust Pre-Setting-NA Option Checksum Panel Information Reset Preset EEPROM</p> <p>*. 2006/06/07: MCU firmware date. *. T-LSDO17A-0802: MCU firmware version information (this information must be appended due to a compatibility problem report.)</p> <p>3) Reset: Factory reset 2) Bus Stop: The communication Line ON / OFF</p>

3 Alignments and Adjustments

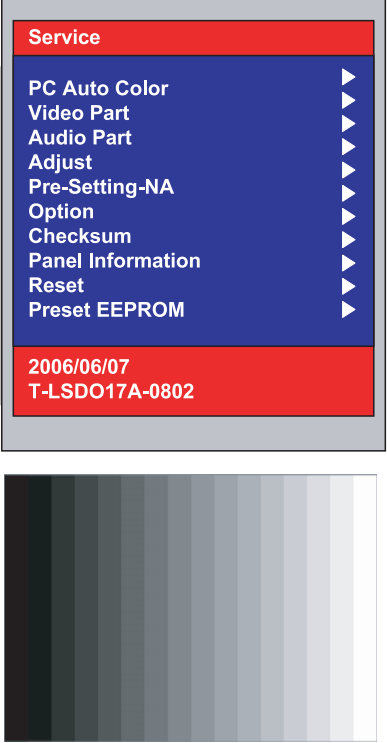
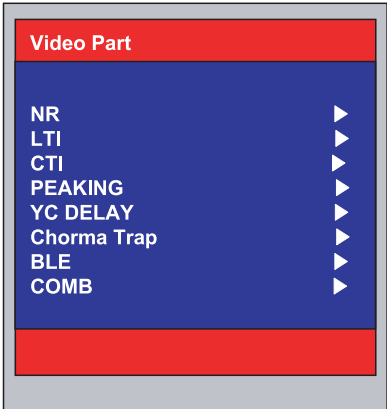
No	Function	Action method
2.		<p>Move to the (-) / (+) key, select the 'Enter' key.</p> <p>1) PC Auto Color/ Video Auto Color : in case that color of all screen is wrong, excute the PC Auto color at 16 gray pattern (refer to attach left 16gray pattern)</p> <p>4) Checksum: MCU firmware checksum information (this information must be appended due to a compatibility problem report.)</p>
3.		<p>2) Video Part</p> <ul style="list-style-type: none"> - NR : Temporal NR / Spatial NR - LTI : LTI LOW / HIGH - CTI : CTI SCALER / DECODER - PEAKING : Pos Peak Neg Peak / Peak Coring - YC DELAY - Chorma Trap - BLE BLE START / SLOPE - COMB Comb Contrast / Brightness / Saturation <p>*.When Panel Information selected</p>

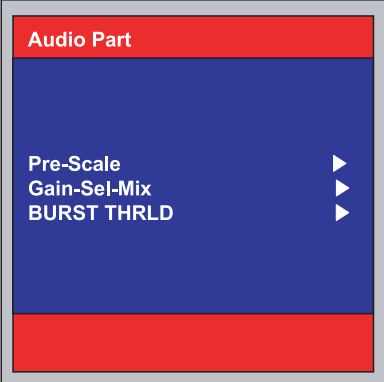
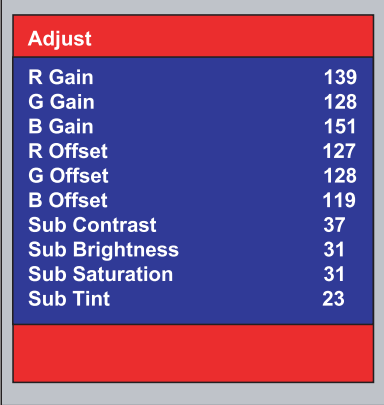
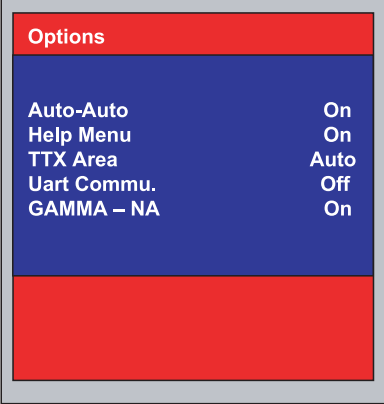
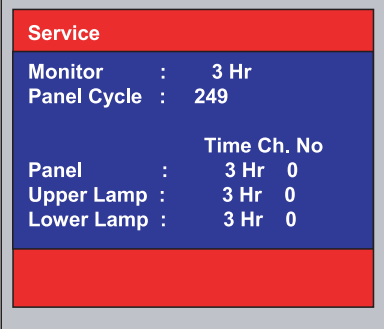
No	Function	Action method
4.		<p>3) Audio Part</p> <ul style="list-style-type: none"> - Pre- Scale : SPK / SCART - Gain-Sel -Mix - BURST THRLD H / L / CHECK THRLD / P-S MUTE <p>*.When Panel Information selected</p>
5.		<p>4) Adjust</p> <p>5) Pre-Setting - NA</p> <p>*.When Panel Information selected</p>
6.		<p>6) Options</p> <ul style="list-style-type: none"> - Auto-Auto - Help Menu - TTX Area - Uart Commu. - GAMMA - NA <p>7) Checksum</p> <p>*.When Panel Information selected</p>
7.		<p>8) Panel Information various function are included in information.</p> <ol style="list-style-type: none"> 1. Monitor On Time : Power On Time 2. Panel Cycle : Panel On/off time (Power off, Mode change, DPMS on/off ...) 3. Panel : Panel on Time (when the panel is changed , select the Reset) 4. Lower lamp : Lower lamp on time (when the Lower lamp is changed , select the Reset) 5. Upper lamp : Upper Lamp on time (when the Upper Lamp is changed , select the Reset) <p>9) Reset</p> <p>10) Preset EEPROM</p>

3 Alignments and Adjustments

Memo

4 Troubleshooting

4-1 No Power

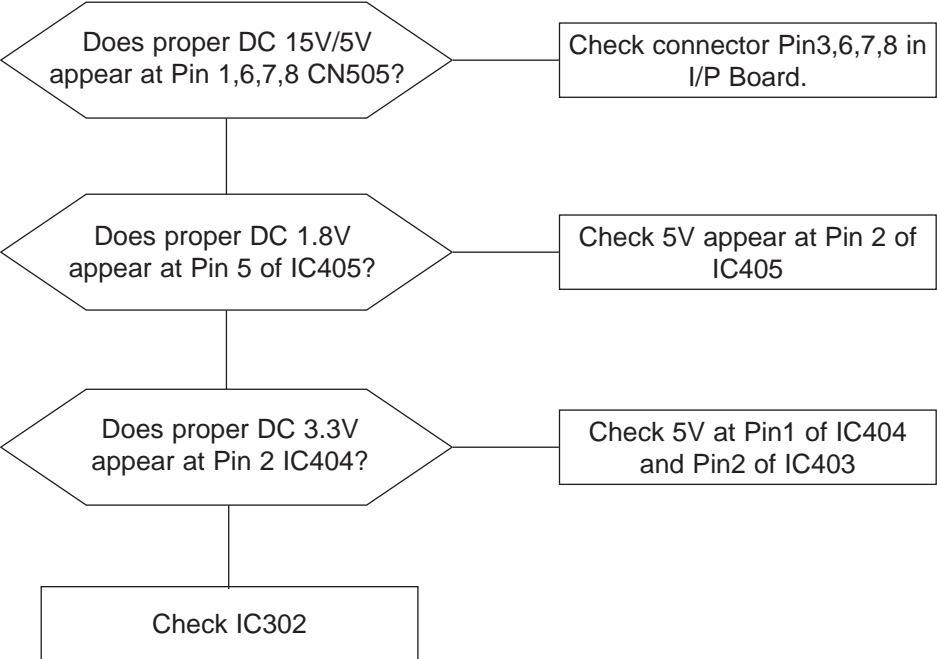

4 Troubleshooting

4-2 No Picture

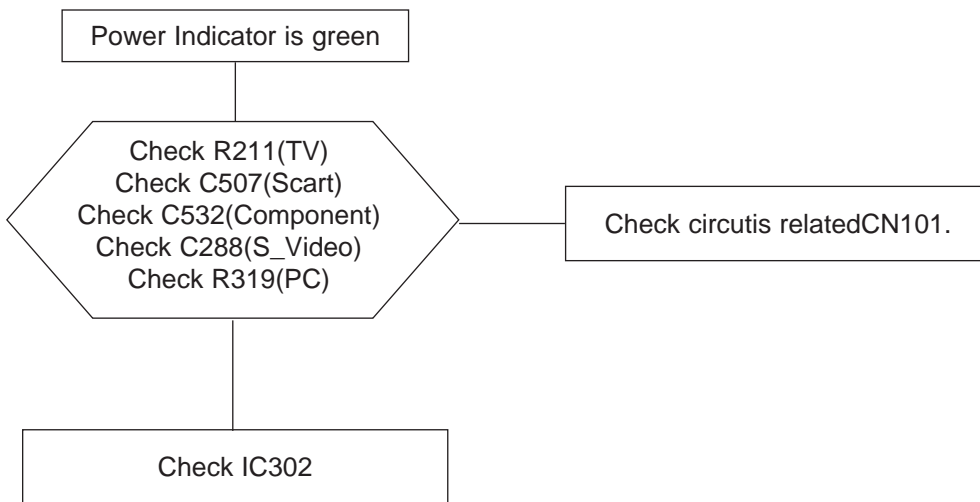

4-3 No Sound

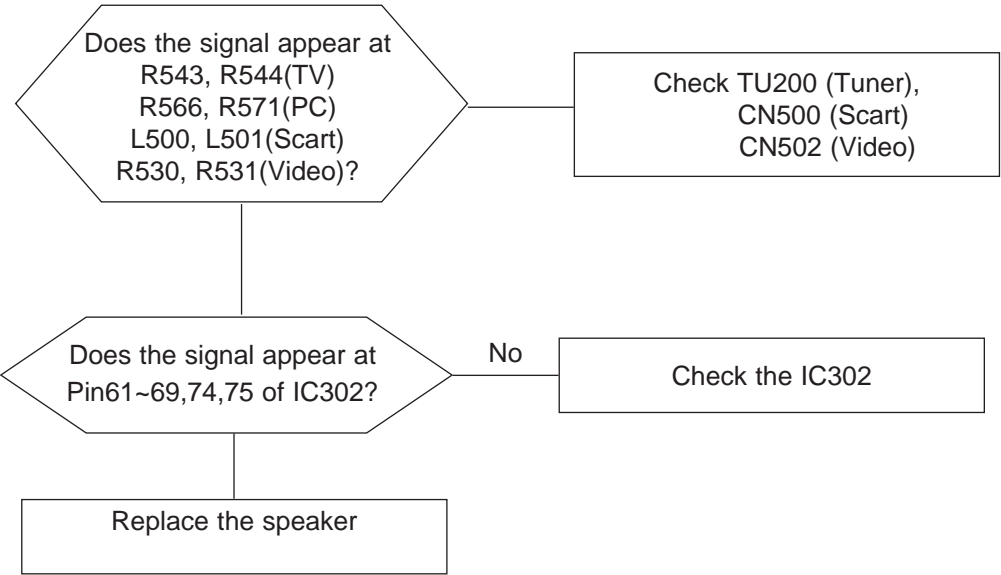

4 Troubleshooting

Memo

5 Exploded View and Parts List

-You can search for updated part codes through ITSELF web site.
URL : <http://itself.sec.samsung.co.kr>

5-1 LS17DOA Exploded View

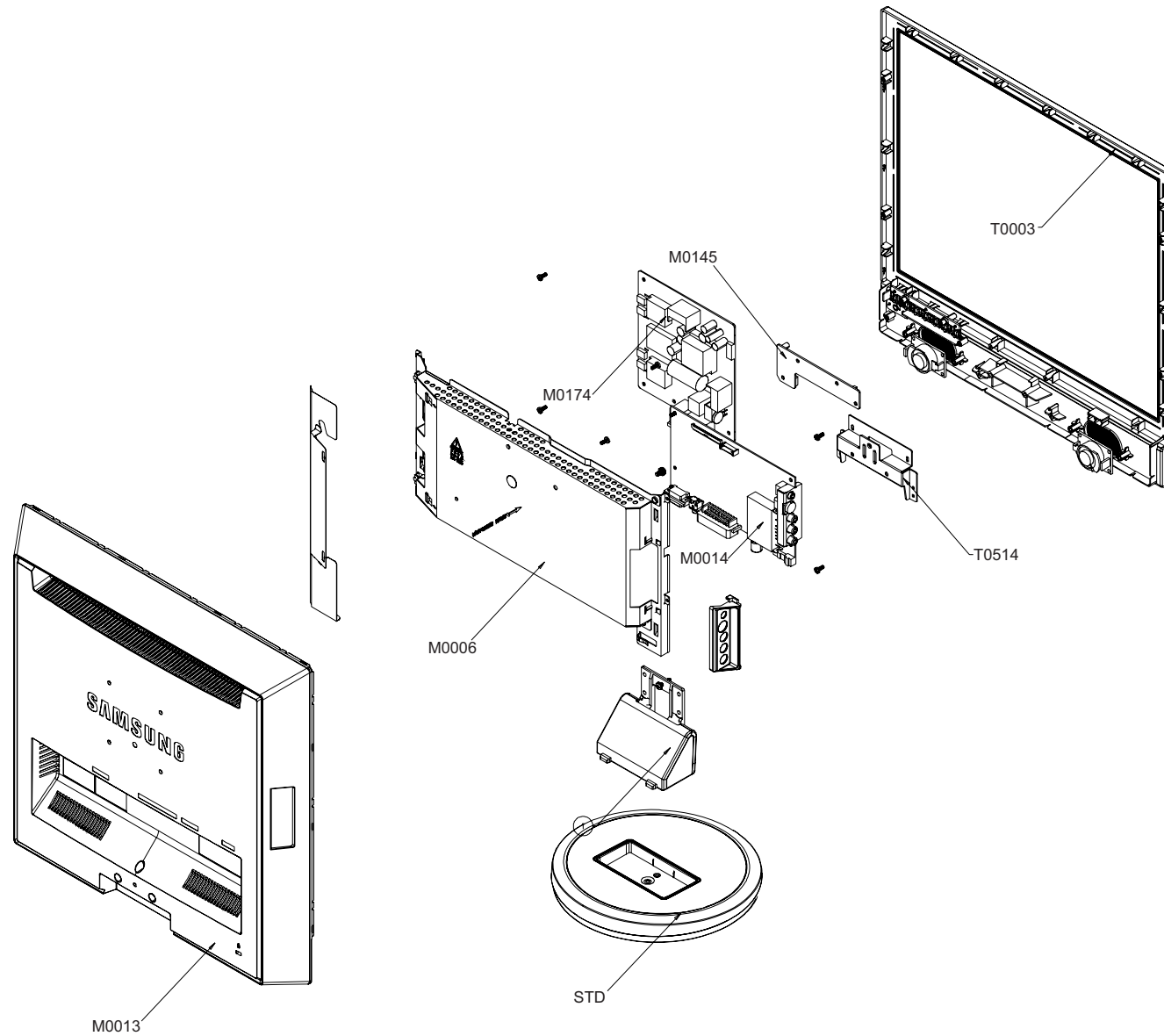

5-1-1 Parts List

Location.No	CODE-NO	SPECIFICATION & DESCRIPTION	Q'TY	SA/SNA	REMARK
T0003	BN96-03869B	ASSY COVER P-FRONT;DVORAK 17",ABS HB,GR7	1	S.A	
T0514	BN61-02578A	BRACKET-SUPPORT;DVORAK,SECC,1.2	1	S.N.A	
M0145	BN96-03847A	ASSY BOARD P-FUNCTION IR;DVORAK,SJ06-01-	1	S.N.A	
M0174	BN44-00137B	IP BOARD;PWI1704SM(A),DVORAK,3.8mA,7.5mA	1	S.N.A	
M0014	BN94-01039A	ASSY PCB MAIN-STZ;LS17DOASS/EDC	1	S.N.A	
M0006	BN96-03870B	ASSY SHIELD P-COVER;DVORAK17,SECC,0.8	1	S.A	
STD	BN96-02966A	ASSY STAND P-BODY;LS19DOW,HIPS HB,BK24,Z	1	S.A	
M0013	BN96-03871A	ASSY COVER P-REAR;DVORAK 17",HIPS HB,BK2	1	S.A	

5-2 LS19DOA Exploded View

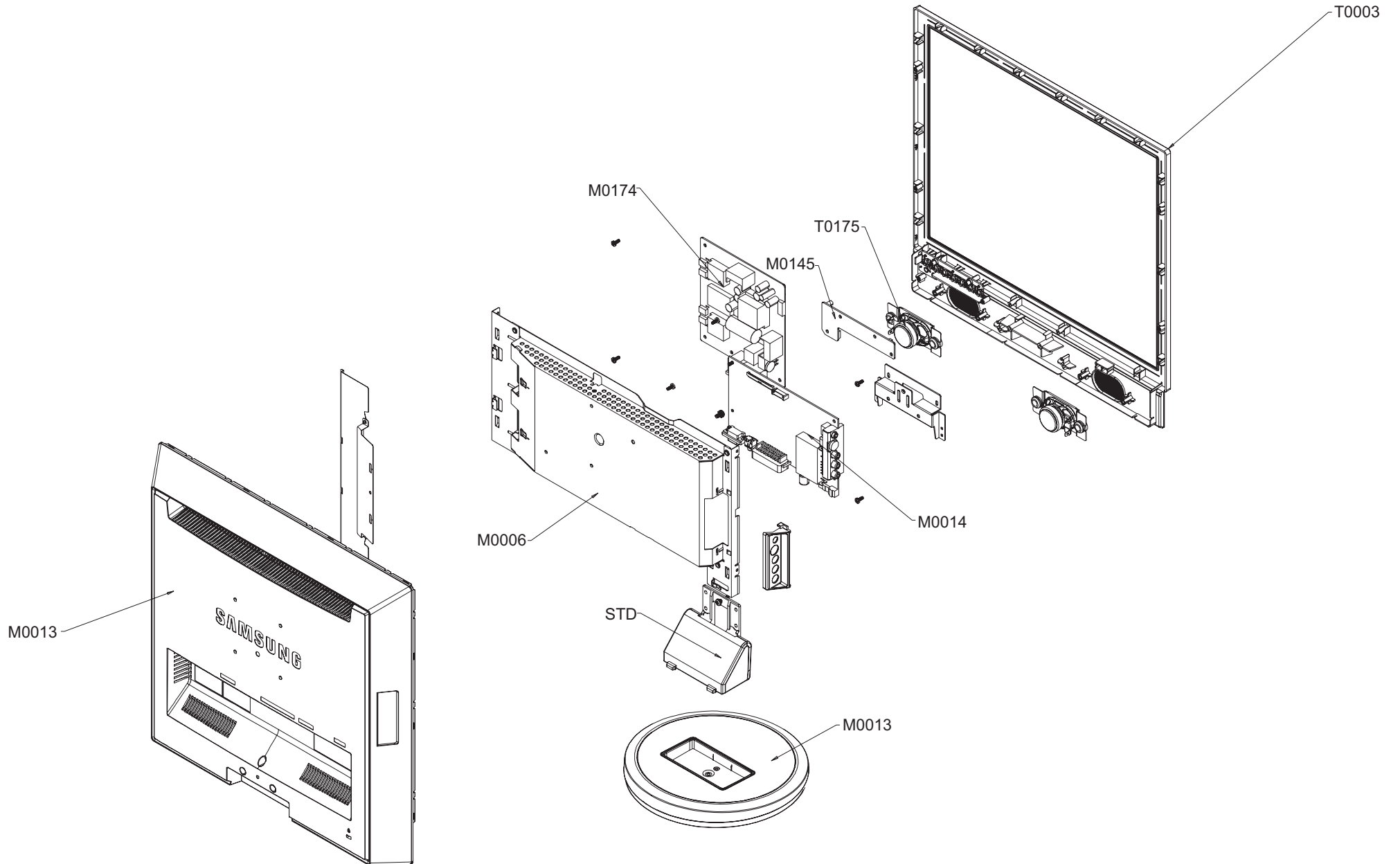

5-2-1 LS19DOA Parts List

Location.No	CODE-NO	SPECIFICATION & DESCRIPTION	Q'TY	SA/SNA	REMARK
T0003	BN96-03872B	ASSY COVER P-FRONT;DVORAK 19",ABS HB,GR7	1	S.A	
T0175	BN96-03733A	ASSY SPEAKER P;16 \times Ø,Dvorak, 19, VE Type,	1	S.A	
M0145	BN96-03847A	ASSY BOARD P-FUNCTION IR;DVORAK,SJ06-01-	1	S.N.A	
M0174	BN44-00137B	IP BOARD;PWI1704SM(A),DVORAK,3.8mA,7.5mA	1	S.N.A	
M0014	BN94-01038A	ASSY PCB MAIN-STZ;LS19DOASS/EDC	1	S.N.A	
M0006	BN96-03874B	ASSY SHIELD P-COVER;DVORAK19,SECC,0.8	1	S.A	
STD	BN96-02966A	ASSY STAND P-BODY;LS19DOW,HIPS HB,BK24,Z	1	S.A	
M0013	BN96-02332D	ASSY STAND P-BASE;HA19AS/BS,HIPS,GR70 &	1	S.A	
M0013	BN96-03873A	ASSY COVER P-REAR;DVORAK 19",HIPS HB,BK2	1	S.A	

6 Electrical Parts List

-You can search for updated part codes through ITSELF web site.

URL : <http://itself.sec.samsung.co.kr/>

6-1 LS17DOA Parts List

Level	Loc. No.	Code No.	Description & Specification	Q'ty	SA/SNA
		LS17DOASS/EDC	741MP,SAE1/S17AZ-LDO,17,LCD-MO,NETHERLAN		
0.1	M0216	BN90-00814A	ASSY STAND;LS19DOWSS/XAA,DO19WS	1	S.N.A
..2	STD	BN96-02966A	ASSY STAND P-BODY;LS19DOW,HIPS HB,BK24,Z	1	S.A
...3	M0081	6003-000275	SCREW-TAPTITE;BH,+,-,B,M3,L10,ZPC(BLK),S	4	S.N.A
...3		BN63-02128A	COVER-STAND FRONT;LS19DOW,HIPS,T2.5,HB,B	1	S.N.A
...3		BN63-02129A	COVER-STAND REAR;LS19DOW,HIPS,T2.5,HB,BK	1	S.N.A
...3	T0054	BN96-02967A	ASSY HINGE P;LS19DOW,ZNDC	1	S.N.A
0.1	M0001	BN90-01008A	ASSY COVER FRONT;DVORAK 17,4:3	1	S.N.A
..2	T0003	BN96-03869B	ASSY COVER P-FRONT;DVORAK 17",ABS HB,GR7	1	S.A
...3	M0081	6003-000282	SCREW-TAPTITE;BH,+,-,B,M3,L8,ZPC(BLK),SW	3	S.N.A
...3	M0081	6003-000282	SCREW-TAPTITE;BH,+,-,B,M3,L8,ZPC(BLK),SW	4	S.N.A
...3	T0069	AA60-00171E	SPACER-FELT;43L2,FELT,300,T0.5,5	4	S.N.A
...3	M0112	BN63-02681A	COVER-FRONT;DVORAK,ABS,HB,GR70	1	S.N.A
...3	T0059	BN64-00506A	INDICATOR LED;DVORAK,ACRYL,CLR	1	S.N.A
...3	T0022	BN64-00507A	KNOB-CONTROL;DVORAK,ABS,HB,GR70	1	S.N.A
...3	T0175	BN96-00515C	ASSY SPEAKER P;8ohm,Dvorak 17",2W,2pin,4	1	S.N.A
...3	T0175	BN96-00518B	ASSY SPEAKER P;16ohm,Dvorak, 17,Right,2W	1	S.N.A
...3	M0145	BN96-03847A	ASSY BOARD P-FUNCTION IR;DVORAK,SJ06-01-	1	S.N.A
0.1	M0002	BN90-01009A	ASSY COVER REAR;DVORAK 17,4:3	1	S.N.A
..2	M0013	BN96-03871A	ASSY COVER P-REAR;DVORAK 17",HIPS HB,BK2	1	S.A
...3	M0113	BN61-01581A	BRACKET-VESA;B117/19BS,SECC,T1.0	2	S.N.A
...3	M0006	BN63-02682A	COVER-REAR;DVORAK,HIPS,HB,BK24	1	S.N.A
0.1	M0106	BN91-00841H	ASSY LCD-STZ;PO24FS	1	S.N.A
..2	M0215	BN07-00206A	LCD-PANEL;LTM170EX-L21,Bizet,6BIT FRC,35	1	S.A
0.1	M0017	BN91-01132A	ASSY CHASSIS-STZ;LS17DOASS/EDC	1	S.A
..2	M0081	6003-000282	SCREW-TAPTITE;BH,+,-,B,M3,L8,ZPC(BLK),SW	3	S.N.A
..2	M0081	6003-001439	SCREW-TAPTITE;BH,+,-,S,M4,L8,ZPC(YEL)	1	S.N.A
..2		BN61-02577A	HOLDER-JACK;DVORAK,ABS,BK24,V0	1	S.N.A
..2	T0376	BN63-02134A	SHIELD-VIDEO;LS19DOW,SPT0.2	1	S.N.A
..2	M0014	BN94-01039A	ASSY PCB MAIN-STZ;LS17DOASS/EDC	1	S.N.A
...3	SUB05	0202-001477	SOLDER-CREAM;LST309-M,-,D20-45\$,96.5Sn/	0.599	S.N.A
...3	T0245	0202-001522	SOLDER-WIRE FLUX;LFA3-107,-,D1.2,96.5Sn/	0.003	S.N.A
...3	CN100	3701-001219	CONNECTOR-DSUB;15P,3R,FEMALE,ANGLE,AUF	1	S.A
...3	CN300	3711-005884	HEADER-BOARD TO BOARD;BOX,30P,2R,2mm,ANG	1	S.A
...3	JA330	3722-000143	JACK-PHONE;1P(VER),AG,BLK,ANGLE	1	S.A
...3	CN500	3722-000183	JACK-SCART;21P,SN,BLK	1	S.A
...3	CN501	3722-002081	JACK-EAR PHONE;5P/2C,-,SnPb,L-BLU,-	1	S.A
...3	JA333	3722-002267	JACK-PIN;3P,AU,RED/WHT/YEL,ANGLE	1	S.A
...3	CN200	3722-002275	JACK-DIN;4P,-,SN,BLK,-	1	S.A
...3	CIS3	BN40-00093A	TUNER;VFT-6C/W235S,VFT-6C/W235S,PAL B/G,	1	S.A
...3	MAIN	BN97-01100A	ASSY MICOM-MAIN;LS17DOASS/EDC,W/W	1	S.N.A
....4	IC115	1107-001580	IC-FLASH MEMORY;MX25L4005,4Mbit,512Kx8Bi	1	S.N.A
...3	T0174	BN97-01101A	ASSY SMD;LS17DOASS/EDC	1	S.N.A
....4	D100	0401-001056	DIODE-SWITCHING;MMBD4148SE,100V,200mA,SO	1	S.A
....4	D101	0401-001056	DIODE-SWITCHING;MMBD4148SE,100V,200mA,SO	1	S.A
....4	D102	0401-001056	DIODE-SWITCHING;MMBD4148SE,100V,200mA,SO	1	S.A
....4	D201	0401-001056	DIODE-SWITCHING;MMBD4148SE,100V,200mA,SO	1	S.A
....4	D516	0401-001056	DIODE-SWITCHING;MMBD4148SE,100V,200mA,SO	1	S.A
....4	D517	0401-001056	DIODE-SWITCHING;MMBD4148SE,100V,200mA,SO	1	S.A
....4	D518	0401-001056	DIODE-SWITCHING;MMBD4148SE,100V,200mA,SO	1	S.A
....4	D519	0401-001056	DIODE-SWITCHING;MMBD4148SE,100V,200mA,SO	1	S.A
....4	D523	0401-001056	DIODE-SWITCHING;MMBD4148SE,100V,200mA,SO	1	S.A
....4	D300	0401-001099	DIODE-SWITCHING;1N4148WS,75V,150mA,SOD-3	1	S.A

6 Electrical Parts List

Level	Loc. No.	Code No.	Description & Specification	Q'ty	SA/SNA
....4	D400	0402-000553	DIODE-SCHOTTKY;SS24/B240,40V,2000mA,DO-2	1	S.A
....4	D401	0402-001098	DIODE-RECTIFIER;SK34,40V,3A,SMC,TP	1	S.A
....4	D402	0402-001098	DIODE-RECTIFIER;SK34,40V,3A,SMC,TP	1	S.A
....4	ZD100	0403-000258	DIODE-ZENER;BZX84C5V6,5.2-6V,225mW,SOT-2	1	S.A
....4	ZD101	0403-000258	DIODE-ZENER;BZX84C5V6,5.2-6V,225mW,SOT-2	1	S.A
....4	ZD102	0403-000258	DIODE-ZENER;BZX84C5V6,5.2-6V,225mW,SOT-2	1	S.A
....4	D103	0403-000579	DIODE-ZENER;BZX84C5V1,4.8-5.4V,200mW,SOT	1	S.A
....4	D104	0403-000579	DIODE-ZENER;BZX84C5V1,4.8-5.4V,200mW,SOT	1	S.A
....4	D105	0403-000579	DIODE-ZENER;BZX84C5V1,4.8-5.4V,200mW,SOT	1	S.A
....4	D106	0403-000579	DIODE-ZENER;BZX84C5V1,4.8-5.4V,200mW,SOT	1	S.A
....4	D107	0403-000579	DIODE-ZENER;BZX84C5V1,4.8-5.4V,200mW,SOT	1	S.A
....4	D108	0403-000579	DIODE-ZENER;BZX84C5V1,4.8-5.4V,200mW,SOT	1	S.A
....4	D109	0403-000579	DIODE-ZENER;BZX84C5V1,4.8-5.4V,200mW,SOT	1	S.A
....4	D200	0403-001425	DIODE-ZENER;BZX84C33,31-35V,350mW,SOT-23	1	S.A
....4	D110	0403-001435	DIODE-ZENER;QZX363C5V6,5.32-5.88V,200MW,	1	S.A
....4	D202	0406-001163	DIODE-TVS;CDS3C05GTA,6.4V/-/-,SMD	1	S.A
....4	D203	0406-001163	DIODE-TVS;CDS3C05GTA,6.4V/-/-,SMD	1	S.A
....4	D504	0406-001163	DIODE-TVS;CDS3C05GTA,6.4V/-/-,SMD	1	S.A
....4	D505	0406-001163	DIODE-TVS;CDS3C05GTA,6.4V/-/-,SMD	1	S.A
....4	D506	0406-001163	DIODE-TVS;CDS3C05GTA,6.4V/-/-,SMD	1	S.A
....4	D507	0406-001163	DIODE-TVS;CDS3C05GTA,6.4V/-/-,SMD	1	S.A
....4	D508	0406-001163	DIODE-TVS;CDS3C05GTA,6.4V/-/-,SMD	1	S.A
....4	D509	0406-001163	DIODE-TVS;CDS3C05GTA,6.4V/-/-,SMD	1	S.A
....4	D510	0406-001163	DIODE-TVS;CDS3C05GTA,6.4V/-/-,SMD	1	S.A
....4	D511	0406-001163	DIODE-TVS;CDS3C05GTA,6.4V/-/-,SMD	1	S.A
....4	D512	0406-001163	DIODE-TVS;CDS3C05GTA,6.4V/-/-,SMD	1	S.A
....4	D513	0406-001163	DIODE-TVS;CDS3C05GTA,6.4V/-/-,SMD	1	S.A
....4	D514	0406-001163	DIODE-TVS;CDS3C05GTA,6.4V/-/-,SMD	1	S.A
....4	D515	0406-001163	DIODE-TVS;CDS3C05GTA,6.4V/-/-,SMD	1	S.A
....4	D522	0407-000123	DIODE-ARRAY;DAN202K,80V,100mA,CA2-3,SOT-	1	S.A
....4	Q503	0501-000280	TR-SMALL SIGNAL;KSA1182,PNP,150MW,SOT-23	1	S.A
....4	Q101	0501-000342	TR-SMALL SIGNAL;KSC1623-Y,NPN,200mW,SOT-	1	S.A
....4	Q102	0501-000342	TR-SMALL SIGNAL;KSC1623-Y,NPN,200mW,SOT-	1	S.A
....4	Q200	0501-000342	TR-SMALL SIGNAL;KSC1623-Y,NPN,200mW,SOT-	1	S.A
....4	Q502	0501-000342	TR-SMALL SIGNAL;KSC1623-Y,NPN,200mW,SOT-	1	S.A
....4	Q507	0501-000342	TR-SMALL SIGNAL;KSC1623-Y,NPN,200mW,SOT-	1	S.A
....4	Q400	0501-002080	TR-SMALL SIGNAL;2SC2412K,NPN,200mW,SC-59	1	S.A
....4	Q401	0501-002080	TR-SMALL SIGNAL;2SC2412K,NPN,200mW,SC-59	1	S.A
....4	Q402	0501-002080	TR-SMALL SIGNAL;2SC2412K,NPN,200mW,SC-59	1	S.A
....4	Q403	0501-002080	TR-SMALL SIGNAL;2SC2412K,NPN,200mW,SC-59	1	S.A
....4	Q404	0501-002080	TR-SMALL SIGNAL;2SC2412K,NPN,200mW,SC-59	1	S.A
....4	Q500	0501-002080	TR-SMALL SIGNAL;2SC2412K,NPN,200mW,SC-59	1	S.A
....4	Q501	0501-002080	TR-SMALL SIGNAL;2SC2412K,NPN,200mW,SC-59	1	S.A
....4	Q409	0505-001170	FET-SILICON;SI9933ADY-T1,P,-20V,3.4A,0.0	1	S.A
....4	Q409	0505-001170	FET-SILICON;SI9933ADY-T1,P,-20V,3.4A,0.0	1	S.A
....4	IC107	1002-001399	IC-D/A CONVERTER;PCM1754,24BIT,SSOP,16P,	1	S.A
....4	IC112	1103-000129	IC-EEPROM;24C02,2Kbit,256x8Bit,SOP,8P,5x	1	S.A
....4	IC112	1103-001279	IC-EEPROM;24C32,32Kbit,4Kx8Bit,SOP,8P,5x	1	S.A
....4	T0085	1201-001980	IC-AUDIO AMP;TDA7266D,SO,20P,16X11.1MM,-	1	S.A
....4	T0087	1203-002842	IC-POSI.FIXED REG.;AP1117D-33A,TO-252,3P	1	S.A
....4	IC405	1203-003015	IC-DC/DC CONVERTER;MP1410ES,SOIC,8P,4.9x	1	S.A
....4	T0170	1203-003059	IC-SWITCH VOL. REG.;MP1583,SOIC,8P,4.9x3	1	S.A
....4	T0170	1203-003059	IC-SWITCH VOL. REG.;MP1583,SOIC,8P,4.9x3	1	S.A
....4	T0087	1203-003952	IC-POSI.FIXED REG.;KA7805ERTM,DPAK,3P,6.	1	S.A
....4	R105	2007-000043	R-CHIP;1Kohm,1%,1/10W,TP,1608	1	S.A
....4	R108	2007-000043	R-CHIP;1Kohm,1%,1/10W,TP,1608	1	S.A
....4	R132	2007-000043	R-CHIP;1Kohm,1%,1/10W,TP,1608	1	S.A
....4	R133	2007-000043	R-CHIP;1Kohm,1%,1/10W,TP,1608	1	S.A
....4	R313	2007-000052	R-CHIP;10Kohm,1%,1/10W,TP,1608	1	S.A
....4	R335	2007-000052	R-CHIP;10Kohm,1%,1/10W,TP,1608	1	S.A
....4	R401	2007-000052	R-CHIP;10Kohm,1%,1/10W,TP,1608	1	S.A
....4	R421	2007-000067	R-CHIP;15Kohm,1%,1/10W,TP,1608	1	S.A
....4	R106	2007-000070	R-CHIP;0ohm,5%,1/10W,TP,1608	1	S.A

6 Electrical Parts List

Level	Loc. No.	Code No.	Description & Specification	Q'ty	SA/SNA
....4	R338	2007-000074	R-CHIP;100ohm,5%,1/10W,TP,1608	1	SA
....4	R339	2007-000074	R-CHIP;100ohm,5%,1/10W,TP,1608	1	SA
....4	R340	2007-000074	R-CHIP;100ohm,5%,1/10W,TP,1608	1	SA
....4	R341	2007-000074	R-CHIP;100ohm,5%,1/10W,TP,1608	1	SA
....4	R342	2007-000074	R-CHIP;100ohm,5%,1/10W,TP,1608	1	SA
....4	R343	2007-000074	R-CHIP;100ohm,5%,1/10W,TP,1608	1	SA
....4	R351	2007-000074	R-CHIP;100ohm,5%,1/10W,TP,1608	1	SA
....4	R352	2007-000074	R-CHIP;100ohm,5%,1/10W,TP,1608	1	SA
....4	R402	2007-000074	R-CHIP;100ohm,5%,1/10W,TP,1608	1	SA
....4	R581	2007-000074	R-CHIP;100ohm,5%,1/10W,TP,1608	1	SA
....4	R584	2007-000074	R-CHIP;100ohm,5%,1/10W,TP,1608	1	SA
....4	R606	2007-000074	R-CHIP;100ohm,5%,1/10W,TP,1608	1	SA
....4	R200	2007-000076	R-CHIP;330ohm,5%,1/10W,TP,1608	1	SA
....4	R518	2007-000077	R-CHIP;470ohm,5%,1/10W,TP,1608	1	SA
....4	R214	2007-000078	R-CHIP;1Kohm,5%,1/10W,TP,1608	1	SA
....4	R409	2007-000078	R-CHIP;1Kohm,5%,1/10W,TP,1608	1	SA
....4	R415	2007-000078	R-CHIP;1Kohm,5%,1/10W,TP,1608	1	SA
....4	R423	2007-000078	R-CHIP;1Kohm,5%,1/10W,TP,1608	1	SA
....4	R539	2007-000078	R-CHIP;1Kohm,5%,1/10W,TP,1608	1	SA
....4	R540	2007-000078	R-CHIP;1Kohm,5%,1/10W,TP,1608	1	SA
....4	R542	2007-000078	R-CHIP;1Kohm,5%,1/10W,TP,1608	1	SA
....4	R110	2007-000080	R-CHIP;2Kohm,5%,1/10W,TP,1608	1	SA
....4	R111	2007-000081	R-CHIP;2.7Kohm,5%,1/10W,TP,1608	1	SA
....4	R514	2007-000081	R-CHIP;2.7Kohm,5%,1/10W,TP,1608	1	SA
....4	R101	2007-000084	R-CHIP;4.7Kohm,5%,1/10W,TP,1608	1	SA
....4	R102	2007-000084	R-CHIP;4.7Kohm,5%,1/10W,TP,1608	1	SA
....4	R130	2007-000084	R-CHIP;4.7Kohm,5%,1/10W,TP,1608	1	SA
....4	R131	2007-000084	R-CHIP;4.7Kohm,5%,1/10W,TP,1608	1	SA
....4	R302	2007-000084	R-CHIP;4.7Kohm,5%,1/10W,TP,1608	1	SA
....4	R303	2007-000084	R-CHIP;4.7Kohm,5%,1/10W,TP,1608	1	SA
....4	R315	2007-000084	R-CHIP;4.7Kohm,5%,1/10W,TP,1608	1	SA
....4	R316	2007-000084	R-CHIP;4.7Kohm,5%,1/10W,TP,1608	1	SA
....4	R317	2007-000084	R-CHIP;4.7Kohm,5%,1/10W,TP,1608	1	SA
....4	R318	2007-000084	R-CHIP;4.7Kohm,5%,1/10W,TP,1608	1	SA
....4	R319	2007-000084	R-CHIP;4.7Kohm,5%,1/10W,TP,1608	1	SA
....4	R344	2007-000084	R-CHIP;4.7Kohm,5%,1/10W,TP,1608	1	SA
....4	R349	2007-000084	R-CHIP;4.7Kohm,5%,1/10W,TP,1608	1	SA
....4	R350	2007-000084	R-CHIP;4.7Kohm,5%,1/10W,TP,1608	1	SA
....4	R400	2007-000084	R-CHIP;4.7Kohm,5%,1/10W,TP,1608	1	SA
....4	R405	2007-000084	R-CHIP;4.7Kohm,5%,1/10W,TP,1608	1	SA
....4	R414	2007-000084	R-CHIP;4.7Kohm,5%,1/10W,TP,1608	1	SA
....4	R605	2007-000084	R-CHIP;4.7Kohm,5%,1/10W,TP,1608	1	SA
....4	R408	2007-000087	R-CHIP;6.8Kohm,5%,1/10W,TP,1608	1	SA
....4	R424	2007-000087	R-CHIP;6.8Kohm,5%,1/10W,TP,1608	1	SA
....4	R100	2007-000090	R-CHIP;10Kohm,5%,1/10W,TP,1608	1	SA
....4	R103	2007-000090	R-CHIP;10Kohm,5%,1/10W,TP,1608	1	SA
....4	R112	2007-000090	R-CHIP;10Kohm,5%,1/10W,TP,1608	1	SA
....4	R125	2007-000090	R-CHIP;10Kohm,5%,1/10W,TP,1608	1	SA
....4	R135	2007-000090	R-CHIP;10Kohm,5%,1/10W,TP,1608	1	SA
....4	R136	2007-000090	R-CHIP;10Kohm,5%,1/10W,TP,1608	1	SA
....4	R410	2007-000090	R-CHIP;10Kohm,5%,1/10W,TP,1608	1	SA
....4	R412	2007-000090	R-CHIP;10Kohm,5%,1/10W,TP,1608	1	SA
....4	R416	2007-000090	R-CHIP;10Kohm,5%,1/10W,TP,1608	1	SA
....4	R425	2007-000090	R-CHIP;10Kohm,5%,1/10W,TP,1608	1	SA
....4	R512	2007-000090	R-CHIP;10Kohm,5%,1/10W,TP,1608	1	SA
....4	R523	2007-000090	R-CHIP;10Kohm,5%,1/10W,TP,1608	1	SA
....4	R524	2007-000090	R-CHIP;10Kohm,5%,1/10W,TP,1608	1	SA
....4	R525	2007-000090	R-CHIP;10Kohm,5%,1/10W,TP,1608	1	SA
....4	R530	2007-000090	R-CHIP;10Kohm,5%,1/10W,TP,1608	1	SA
....4	R531	2007-000090	R-CHIP;10Kohm,5%,1/10W,TP,1608	1	SA
....4	R537	2007-000090	R-CHIP;10Kohm,5%,1/10W,TP,1608	1	SA
....4	R538	2007-000090	R-CHIP;10Kohm,5%,1/10W,TP,1608	1	SA
....4	R541	2007-000090	R-CHIP;10Kohm,5%,1/10W,TP,1608	1	SA

Level	Loc. No.	Code No.	Description & Specification	Q'ty	SA/SNA
....4	R561	2007-000090	R-CHIP;10Kohm,5%,1/10W,TP,1608	1	SA
....4	R562	2007-000090	R-CHIP;10Kohm,5%,1/10W,TP,1608	1	SA
....4	R563	2007-000090	R-CHIP;10Kohm,5%,1/10W,TP,1608	1	SA
....4	R564	2007-000090	R-CHIP;10Kohm,5%,1/10W,TP,1608	1	SA
....4	R566	2007-000090	R-CHIP;10Kohm,5%,1/10W,TP,1608	1	SA
....4	R568	2007-000090	R-CHIP;10Kohm,5%,1/10W,TP,1608	1	SA
....4	R571	2007-000090	R-CHIP;10Kohm,5%,1/10W,TP,1608	1	SA
....4	R575	2007-000090	R-CHIP;10Kohm,5%,1/10W,TP,1608	1	SA
....4	R576	2007-000090	R-CHIP;10Kohm,5%,1/10W,TP,1608	1	SA
....4	R597	2007-000090	R-CHIP;10Kohm,5%,1/10W,TP,1608	1	SA
....4	R598	2007-000090	R-CHIP;10Kohm,5%,1/10W,TP,1608	1	SA
....4	R601	2007-000090	R-CHIP;10Kohm,5%,1/10W,TP,1608	1	SA
....4	R602	2007-000090	R-CHIP;10Kohm,5%,1/10W,TP,1608	1	SA
....4	R608	2007-000090	R-CHIP;10Kohm,5%,1/10W,TP,1608	1	SA
....4	R137	2007-000091	R-CHIP;12Kohm,5%,1/10W,TP,1608	1	SA
....4	R138	2007-000091	R-CHIP;12Kohm,5%,1/10W,TP,1608	1	SA
....4	R570	2007-000093	R-CHIP;20Kohm,5%,1/10W,TP,1608	1	SA
....4	R201	2007-000094	R-CHIP;22Kohm,5%,1/10W,TP,1608	1	SA
....4	R590	2007-000094	R-CHIP;22Kohm,5%,1/10W,TP,1608	1	SA
....4	R591	2007-000094	R-CHIP;22Kohm,5%,1/10W,TP,1608	1	SA
....4	R202	2007-000102	R-CHIP;100Kohm,5%,1/10W,TP,1608	1	SA
....4	R403	2007-000102	R-CHIP;100Kohm,5%,1/10W,TP,1608	1	SA
....4	R406	2007-000102	R-CHIP;100Kohm,5%,1/10W,TP,1608	1	SA
....4	R407	2007-000102	R-CHIP;100Kohm,5%,1/10W,TP,1608	1	SA
....4	R596	2007-000102	R-CHIP;100Kohm,5%,1/10W,TP,1608	1	SA
....4	R569	2007-000103	R-CHIP;120Kohm,5%,1/10W,TP,1608	1	SA
....4	R205	2007-000106	R-CHIP;220Kohm,5%,1/10W,TP,1608	1	SA
....4	R311	2007-000107	R-CHIP;470Kohm,5%,1/10W,TP,1608	1	SA
....4	R326	2007-000118	R-CHIP;390ohm,5%,1/10W,TP,1608	1	SA
....4	R520	2007-000458	R-CHIP;18Kohm,5%,1/10W,TP,1608	1	SA
....4	R418	2007-000708	R-CHIP;3.9Kohm,1%,1/10W,TP,1608	1	SA
....4	R404	2007-000913	R-CHIP;43Kohm,5%,1/10W,TP,1608	1	SA
....4	R411	2007-000965	R-CHIP;5.1Kohm,5%,1/10W,TP,1608	1	SA
....4	R419	2007-000965	R-CHIP;5.1Kohm,5%,1/10W,TP,1608	1	SA
....4	R422	2007-000965	R-CHIP;5.1Kohm,5%,1/10W,TP,1608	1	SA
....4	R420	2007-001068	R-CHIP;6.8Kohm,1%,1/10W,TP,1608	1	SA
....4	R122	2007-001164	R-CHIP;75ohm,1%,1/10W,TP,1608	1	SA
....4	R123	2007-001164	R-CHIP;75ohm,1%,1/10W,TP,1608	1	SA
....4	R124	2007-001164	R-CHIP;75ohm,1%,1/10W,TP,1608	1	SA
....4	R209	2007-001164	R-CHIP;75ohm,1%,1/10W,TP,1608	1	SA
....4	R532	2007-001164	R-CHIP;75ohm,1%,1/10W,TP,1608	1	SA
....4	R216	2007-001167	R-CHIP;75ohm,5%,1/10W,TP,1608	1	SA
....4	R217	2007-001167	R-CHIP;75ohm,5%,1/10W,TP,1608	1	SA
....4	R503	2007-001167	R-CHIP;75ohm,5%,1/10W,TP,1608	1	SA
....4	R504	2007-001167	R-CHIP;75ohm,5%,1/10W,TP,1608	1	SA
....4	R505	2007-001167	R-CHIP;75ohm,5%,1/10W,TP,1608	1	SA
....4	R506	2007-001167	R-CHIP;75ohm,5%,1/10W,TP,1608	1	SA
....4	R508	2007-001167	R-CHIP;75ohm,5%,1/10W,TP,1608	1	SA
....4	R516	2007-001167	R-CHIP;75ohm,5%,1/10W,TP,1608	1	SA
....4	R521	2007-001167	R-CHIP;75ohm,5%,1/10W,TP,1608	1	SA
....4	R522	2007-001167	R-CHIP;75ohm,5%,1/10W,TP,1608	1	SA
....4	R208	2007-002906	R-CHIP;200Kohm,1%,1/10W,TP,1608	1	SA
....4	R417	2007-007004	R-CHIP;12Kohm,1%,1/10W,TP,1608	1	SA
....4	R212	2007-007352	R-CHIP;130Kohm,1%,1/10W,TP,1608	1	SA
....4	RA300	2011-000881	R-NET;33ohm,5%,1/16W,L,CHIP,8P,TP,3.2x1.	1	SA
....4	RA301	2011-000881	R-NET;33ohm,5%,1/16W,L,CHIP,8P,TP,3.2x1.	1	SA
....4	RA302	2011-000881	R-NET;33ohm,5%,1/16W,L,CHIP,8P,TP,3.2x1.	1	SA
....4	RA303	2011-000881	R-NET;33ohm,5%,1/16W,L,CHIP,8P,TP,3.2x1.	1	SA
....4	RA304	2011-000881	R-NET;33ohm,5%,1/16W,L,CHIP,8P,TP,3.2x1.	1	SA
....4	C525	2203-000140	C-CER,CHIP;1.5nF,10%,50V,X7R,1608	1	SA
....4	C526	2203-000140	C-CER,CHIP;1.5nF,10%,50V,X7R,1608	1	SA
....4	C535	2203-000140	C-CER,CHIP;1.5nF,10%,50V,X7R,1608	1	SA
....4	C536	2203-000140	C-CER,CHIP;1.5nF,10%,50V,X7R,1608	1	SA

6 Electrical Parts List

Level	Loc. No.	Code No.	Description & Specification	Q'ty	SA/SNA
....4	C233	2203-000189	C-CER,CHIP;100nF,+80-20%,25V,Y5V,1608	1	SA
....4	C307	2203-000189	C-CER,CHIP;100nF,+80-20%,25V,Y5V,1608	1	SA
....4	C309	2203-000189	C-CER,CHIP;100nF,+80-20%,25V,Y5V,1608	1	SA
....4	C310	2203-000189	C-CER,CHIP;100nF,+80-20%,25V,Y5V,1608	1	SA
....4	C311	2203-000189	C-CER,CHIP;100nF,+80-20%,25V,Y5V,1608	1	SA
....4	C312	2203-000189	C-CER,CHIP;100nF,+80-20%,25V,Y5V,1608	1	SA
....4	C313	2203-000189	C-CER,CHIP;100nF,+80-20%,25V,Y5V,1608	1	SA
....4	C314	2203-000189	C-CER,CHIP;100nF,+80-20%,25V,Y5V,1608	1	SA
....4	C345	2203-000189	C-CER,CHIP;100nF,+80-20%,25V,Y5V,1608	1	SA
....4	C347	2203-000189	C-CER,CHIP;100nF,+80-20%,25V,Y5V,1608	1	SA
....4	C348	2203-000189	C-CER,CHIP;100nF,+80-20%,25V,Y5V,1608	1	SA
....4	C355	2203-000189	C-CER,CHIP;100nF,+80-20%,25V,Y5V,1608	1	SA
....4	C401	2203-000189	C-CER,CHIP;100nF,+80-20%,25V,Y5V,1608	1	SA
....4	C411	2203-000189	C-CER,CHIP;100nF,+80-20%,25V,Y5V,1608	1	SA
....4	C412	2203-000189	C-CER,CHIP;100nF,+80-20%,25V,Y5V,1608	1	SA
....4	C420	2203-000189	C-CER,CHIP;100nF,+80-20%,25V,Y5V,1608	1	SA
....4	C430	2203-000189	C-CER,CHIP;100nF,+80-20%,25V,Y5V,1608	1	SA
....4	C434	2203-000189	C-CER,CHIP;100nF,+80-20%,25V,Y5V,1608	1	SA
....4	C442	2203-000189	C-CER,CHIP;100nF,+80-20%,25V,Y5V,1608	1	SA
....4	C445	2203-000189	C-CER,CHIP;100nF,+80-20%,25V,Y5V,1608	1	SA
....4	C600	2203-000189	C-CER,CHIP;100nF,+80-20%,25V,Y5V,1608	1	SA
....4	C607	2203-000189	C-CER,CHIP;100nF,+80-20%,25V,Y5V,1608	1	SA
....4	C608	2203-000189	C-CER,CHIP;100nF,+80-20%,25V,Y5V,1608	1	SA
....4	C102	2203-000236	C-CER,CHIP;0.1nF,5%,50V,C0G,1608	1	SA
....4	C215	2203-000236	C-CER,CHIP;0.1nF,5%,50V,C0G,1608	1	SA
....4	C216	2203-000236	C-CER,CHIP;0.1nF,5%,50V,C0G,1608	1	SA
....4	C416	2203-000236	C-CER,CHIP;0.1nF,5%,50V,C0G,1608	1	SA
....4	C439	2203-000236	C-CER,CHIP;0.1nF,5%,50V,C0G,1608	1	SA
....4	C447	2203-000236	C-CER,CHIP;0.1nF,5%,50V,C0G,1608	1	SA
....4	C201	2203-000257	C-CER,CHIP;10nF,10%,50V,X7R,1608	1	SA
....4	C209	2203-000257	C-CER,CHIP;10nF,10%,50V,X7R,1608	1	SA
....4	C210	2203-000257	C-CER,CHIP;10nF,10%,50V,X7R,1608	1	SA
....4	C301	2203-000257	C-CER,CHIP;10nF,10%,50V,X7R,1608	1	SA
....4	C403	2203-000257	C-CER,CHIP;10nF,10%,50V,X7R,1608	1	SA
....4	C408	2203-000257	C-CER,CHIP;10nF,10%,50V,X7R,1608	1	SA
....4	C428	2203-000257	C-CER,CHIP;10nF,10%,50V,X7R,1608	1	SA
....4	C429	2203-000257	C-CER,CHIP;10nF,10%,50V,X7R,1608	1	SA
....4	C431	2203-000257	C-CER,CHIP;10nF,10%,50V,X7R,1608	1	SA
....4	C440	2203-000257	C-CER,CHIP;10nF,10%,50V,X7R,1608	1	SA
....4	C441	2203-000257	C-CER,CHIP;10nF,10%,50V,X7R,1608	1	SA
....4	C443	2203-000257	C-CER,CHIP;10nF,10%,50V,X7R,1608	1	SA
....4	C115	2203-000440	C-CER,CHIP;1nF,10%,50V,X7R,1608	1	SA
....4	C303	2203-000440	C-CER,CHIP;1nF,10%,50V,X7R,1608	1	SA
....4	C508	2203-000440	C-CER,CHIP;1nF,10%,50V,X7R,1608	1	SA
....4	C517	2203-000440	C-CER,CHIP;1nF,10%,50V,X7R,1608	1	SA
....4	C519	2203-000440	C-CER,CHIP;1nF,10%,50V,X7R,1608	1	SA
....4	C520	2203-000440	C-CER,CHIP;1nF,10%,50V,X7R,1608	1	SA
....4	C533	2203-000440	C-CER,CHIP;1nF,10%,50V,X7R,1608	1	SA
....4	C534	2203-000440	C-CER,CHIP;1nF,10%,50V,X7R,1608	1	SA
....4	C553	2203-000440	C-CER,CHIP;1nF,10%,50V,X7R,1608	1	SA
....4	C581	2203-000440	C-CER,CHIP;1nF,10%,50V,X7R,1608	1	SA
....4	C582	2203-000440	C-CER,CHIP;1nF,10%,50V,X7R,1608	1	SA
....4	C583	2203-000440	C-CER,CHIP;1nF,10%,50V,X7R,1608	1	SA
....4	C584	2203-000440	C-CER,CHIP;1nF,10%,50V,X7R,1608	1	SA
....4	C211	2203-000491	C-CER,CHIP;2.2nF,10%,50V,X7R,1608	1	SA
....4	C353	2203-000491	C-CER,CHIP;2.2nF,10%,50V,X7R,1608	1	SA
....4	C354	2203-000491	C-CER,CHIP;2.2nF,10%,50V,X7R,1608	1	SA
....4	C574	2203-000604	C-CER,CHIP;22nF,10%,25V,X7R,1608	1	SA
....4	C575	2203-000604	C-CER,CHIP;22nF,10%,25V,X7R,1608	1	SA
....4	C101	2203-000626	C-CER,CHIP;0.022nF,5%,50V,C0G,1608	1	SA
....4	C235	2203-000626	C-CER,CHIP;0.022nF,5%,50V,C0G,1608	1	SA
....4	C304	2203-000626	C-CER,CHIP;0.022nF,5%,50V,C0G,1608	1	SA
....4	C305	2203-000626	C-CER,CHIP;0.022nF,5%,50V,C0G,1608	1	SA

Level	Loc. No.	Code No.	Description & Specification	Q'ty	SA/SNA
....4	C212	2203-000888	C-CER,CHIP;4.7nF,10%,50V,X7R,1608	1	SA
....4	C103	2203-000972	C-CER,CHIP;47nF,10%,16V,X7R,1608	1	SA
....4	C104	2203-000972	C-CER,CHIP;47nF,10%,16V,X7R,1608	1	SA
....4	C105	2203-000972	C-CER,CHIP;47nF,10%,16V,X7R,1608	1	SA
....4	C106	2203-000972	C-CER,CHIP;47nF,10%,16V,X7R,1608	1	SA
....4	C107	2203-000972	C-CER,CHIP;47nF,10%,16V,X7R,1608	1	SA
....4	C108	2203-000972	C-CER,CHIP;47nF,10%,16V,X7R,1608	1	SA
....4	C202	2203-000972	C-CER,CHIP;47nF,10%,16V,X7R,1608	1	SA
....4	C217	2203-000972	C-CER,CHIP;47nF,10%,16V,X7R,1608	1	SA
....4	C218	2203-000972	C-CER,CHIP;47nF,10%,16V,X7R,1608	1	SA
....4	C219	2203-000972	C-CER,CHIP;47nF,10%,16V,X7R,1608	1	SA
....4	C232	2203-000972	C-CER,CHIP;47nF,10%,16V,X7R,1608	1	SA
....4	C236	2203-000972	C-CER,CHIP;47nF,10%,16V,X7R,1608	1	SA
....4	C237	2203-000972	C-CER,CHIP;47nF,10%,16V,X7R,1608	1	SA
....4	C238	2203-000972	C-CER,CHIP;47nF,10%,16V,X7R,1608	1	SA
....4	C504	2203-000972	C-CER,CHIP;47nF,10%,16V,X7R,1608	1	SA
....4	C505	2203-000972	C-CER,CHIP;47nF,10%,16V,X7R,1608	1	SA
....4	C506	2203-000972	C-CER,CHIP;47nF,10%,16V,X7R,1608	1	SA
....4	C507	2203-000972	C-CER,CHIP;47nF,10%,16V,X7R,1608	1	SA
....4	C509	2203-000972	C-CER,CHIP;47nF,10%,16V,X7R,1608	1	SA
....4	C511	2203-000972	C-CER,CHIP;47nF,10%,16V,X7R,1608	1	SA
....4	C512	2203-000972	C-CER,CHIP;47nF,10%,16V,X7R,1608	1	SA
....4	C531	2203-000972	C-CER,CHIP;47nF,10%,16V,X7R,1608	1	SA
....4	C532	2203-000972	C-CER,CHIP;47nF,10%,16V,X7R,1608	1	SA
....4	C400	2203-000975	C-CER,CHIP;47nF,10%,25V,X7R,TP,1608,-	1	SA
....4	C427	2203-000975	C-CER,CHIP;47nF,10%,25V,X7R,TP,1608,-	1	SA
....4	C500	2203-000998	C-CER,CHIP;0.047nF,5%,50V,C0G,1608	1	SA
....4	C501	2203-000998	C-CER,CHIP;0.047nF,5%,50V,C0G,1608	1	SA
....4	C502	2203-000998	C-CER,CHIP;0.047nF,5%,50V,C0G,1608	1	SA
....4	C503	2203-000998	C-CER,CHIP;0.047nF,5%,50V,C0G,1608	1	SA
....4	C513	2203-000998	C-CER,CHIP;0.047nF,5%,50V,C0G,1608	1	SA
....4	C514	2203-000998	C-CER,CHIP;0.047nF,5%,50V,C0G,1608	1	SA
....4	C515	2203-000998	C-CER,CHIP;0.047nF,5%,50V,C0G,1608	1	SA
....4	C112	2203-001071	C-CER,CHIP;0.056nF,5%,50V,C0G,1608	1	SA
....4	C208	2203-001607	C-CER,CHIP;0.22nF,5%,50V,NP0,1608	1	SA
....4	C409	2203-001652	C-CER,CHIP;470nF,+80-20%,16V,Y5V,1608	1	SA
....4	C421	2203-001652	C-CER,CHIP;470nF,+80-20%,16V,Y5V,1608	1	SA
....4	C422	2203-001652	C-CER,CHIP;470nF,+80-20%,16V,Y5V,1608	1	SA
....4	C350	2203-001724	C-CER,CHIP;4700nF,+80-20%,16V,Y5V,3216	1	SA
....4	C407	2203-002793	C-CER,CHIP;1000nF,+80-20%,25V,Y5V,2012	1	SA
....4	C100	2203-005005	C-CER,CHIP;100nF,10%,16V,X7R,1608	1	SA
....4	C204	2203-005005	C-CER,CHIP;100nF,10%,16V,X7R,1608	1	SA
....4	C207	2203-005005	C-CER,CHIP;100nF,10%,16V,X7R,1608	1	SA
....4	C414	2203-005005	C-CER,CHIP;100nF,10%,16V,X7R,1608	1	SA
....4	C425	2203-005005	C-CER,CHIP;100nF,10%,16V,X7R,1608	1	SA
....4	C426	2203-005005	C-CER,CHIP;100nF,10%,16V,X7R,1608	1	SA
....4	C435	2203-005005	C-CER,CHIP;100nF,10%,16V,X7R,1608	1	SA
....4	C437	2203-005005	C-CER,CHIP;100nF,10%,16V,X7R,1608	1	SA
....4	C554	2203-005005	C-CER,CHIP;100nF,10%,16V,X7R,1608	1	SA
....4	C580	2203-005005	C-CER,CHIP;100nF,10%,16V,X7R,1608	1	SA
....4	C109	2203-005065	C-CER,CHIP;1000nF,+80-20%,10V,Y5V,1608	1	SA
....4	C110	2203-005065	C-CER,CHIP;1000nF,+80-20%,10V,Y5V,1608	1	SA
....4	C111	2203-005065	C-CER,CHIP;1000nF,+80-20%,10V,Y5V,1608	1	SA
....4	C113	2203-005065	C-CER,CHIP;1000nF,+80-20%,10V,Y5V,1608	1	SA
....4	C114	2203-005065	C-CER,CHIP;1000nF,+80-20%,10V,Y5V,1608	1	SA
....4	C302	2203-005065	C-CER,CHIP;1000nF,+80-20%,10V,Y5V,1608	1	SA
....4	C315	2203-005065	C-CER,CHIP;1000nF,+80-20%,10V,Y5V,1608	1	SA
....4	C316	2203-005065	C-CER,CHIP;1000nF,+80-20%,10V,Y5V,1608	1	SA
....4	C317	2203-005065	C-CER,CHIP;1000nF,+80-20%,10V,Y5V,1608	1	SA
....4	C318	2203-005065	C-CER,CHIP;1000nF,+80-20%,10V,Y5V,1608	1	SA
....4	C319	2203-005065	C-CER,CHIP;1000nF,+80-20%,10V,Y5V,1608	1	SA
....4	C320	2203-005065	C-CER,CHIP;1000nF,+80-20%,10V,Y5V,1608	1	SA
....4	C321	2203-005065	C-CER,CHIP;1000nF,+80-20%,10V,Y5V,1608	1	SA

6 Electrical Parts List

Level	Loc. No.	Code No.	Description & Specification	Q'ty	SA/SNA
....4	C322	2203-005065	C-CER,CHIP;1000nF,+80-20%,10V,Y5V,1608	1	SA
....4	C323	2203-005065	C-CER,CHIP;1000nF,+80-20%,10V,Y5V,1608	1	SA
....4	C324	2203-005065	C-CER,CHIP;1000nF,+80-20%,10V,Y5V,1608	1	SA
....4	C325	2203-005065	C-CER,CHIP;1000nF,+80-20%,10V,Y5V,1608	1	SA
....4	C326	2203-005065	C-CER,CHIP;1000nF,+80-20%,10V,Y5V,1608	1	SA
....4	C327	2203-005065	C-CER,CHIP;1000nF,+80-20%,10V,Y5V,1608	1	SA
....4	C328	2203-005065	C-CER,CHIP;1000nF,+80-20%,10V,Y5V,1608	1	SA
....4	C329	2203-005065	C-CER,CHIP;1000nF,+80-20%,10V,Y5V,1608	1	SA
....4	C330	2203-005065	C-CER,CHIP;1000nF,+80-20%,10V,Y5V,1608	1	SA
....4	C331	2203-005065	C-CER,CHIP;1000nF,+80-20%,10V,Y5V,1608	1	SA
....4	C332	2203-005065	C-CER,CHIP;1000nF,+80-20%,10V,Y5V,1608	1	SA
....4	C333	2203-005065	C-CER,CHIP;1000nF,+80-20%,10V,Y5V,1608	1	SA
....4	C334	2203-005065	C-CER,CHIP;1000nF,+80-20%,10V,Y5V,1608	1	SA
....4	C335	2203-005065	C-CER,CHIP;1000nF,+80-20%,10V,Y5V,1608	1	SA
....4	C336	2203-005065	C-CER,CHIP;1000nF,+80-20%,10V,Y5V,1608	1	SA
....4	C337	2203-005065	C-CER,CHIP;1000nF,+80-20%,10V,Y5V,1608	1	SA
....4	C338	2203-005065	C-CER,CHIP;1000nF,+80-20%,10V,Y5V,1608	1	SA
....4	C339	2203-005065	C-CER,CHIP;1000nF,+80-20%,10V,Y5V,1608	1	SA
....4	C340	2203-005065	C-CER,CHIP;1000nF,+80-20%,10V,Y5V,1608	1	SA
....4	C341	2203-005065	C-CER,CHIP;1000nF,+80-20%,10V,Y5V,1608	1	SA
....4	C342	2203-005065	C-CER,CHIP;1000nF,+80-20%,10V,Y5V,1608	1	SA
....4	C343	2203-005065	C-CER,CHIP;1000nF,+80-20%,10V,Y5V,1608	1	SA
....4	C344	2203-005065	C-CER,CHIP;1000nF,+80-20%,10V,Y5V,1608	1	SA
....4	C346	2203-005065	C-CER,CHIP;1000nF,+80-20%,10V,Y5V,1608	1	SA
....4	C404	2203-005065	C-CER,CHIP;1000nF,+80-20%,10V,Y5V,1608	1	SA
....4	C405	2203-005065	C-CER,CHIP;1000nF,+80-20%,10V,Y5V,1608	1	SA
....4	C410	2203-005065	C-CER,CHIP;1000nF,+80-20%,10V,Y5V,1608	1	SA
....4	C448	2203-005065	C-CER,CHIP;1000nF,+80-20%,10V,Y5V,1608	1	SA
....4	C524	2203-005065	C-CER,CHIP;1000nF,+80-20%,10V,Y5V,1608	1	SA
....4	C602	2203-005065	C-CER,CHIP;1000nF,+80-20%,10V,Y5V,1608	1	SA
....4	C604	2203-005065	C-CER,CHIP;1000nF,+80-20%,10V,Y5V,1608	1	SA
....4	C578	2203-005261	C-CER,CHIP;1000nF,10%,25V,X7R,3216	1	SA
....4	C579	2203-005261	C-CER,CHIP;1000nF,10%,25V,X7R,3216	1	SA
....4	C423	2203-005437	C-CER,CHIP;10000nF,+80-20%,10V,Y5V,3216	1	SA
....4	C424	2203-005437	C-CER,CHIP;10000nF,+80-20%,10V,Y5V,3216	1	SA
....4	C432	2203-005437	C-CER,CHIP;10000nF,+80-20%,10V,Y5V,3216	1	SA
....4	C436	2203-005437	C-CER,CHIP;10000nF,+80-20%,10V,Y5V,3216	1	SA
....4	C601	2203-005437	C-CER,CHIP;10000nF,+80-20%,10V,Y5V,3216	1	SA
....4	C308	2203-006333	C-CER,CHIP;10000nF,20%,16V,X5R,TP,3216	1	SA
....4	C349	2203-006333	C-CER,CHIP;10000nF,20%,16V,X5R,TP,3216	1	SA
....4	C306	2402-000108	C-AL,SMD;10uF,20%,16V,WT,TP,4.3x4.3x5.2m	1	SA
....4	C406	2402-000108	C-AL,SMD;10uF,20%,16V,WT,TP,4.3x4.3x5.2m	1	SA
....4	C415	2402-001081	C-AL,SMD;100uF,20%,25V,WT,TP,8.3x8.3x10	1	SA
....4	C444	2402-001081	C-AL,SMD;100uF,20%,25V,WT,TP,8.3x8.3x10	1	SA
....4	C300	2402-001086	C-AL,SMD;100UF,20%,16V,WT,TP,6.6X6.6X5.3	1	SA
....4	C417	2402-001086	C-AL,SMD;100UF,20%,16V,WT,TP,6.6X6.6X5.3	1	SA
....4	C203	2402-001128	C-AL,SMD;100UF,20%,16V,WT,TP,6.3X5.7MM	1	SA
....4	C402	2402-001128	C-AL,SMD;100UF,20%,16V,WT,TP,6.3X5.7MM	1	SA
....4	C413	2402-001128	C-AL,SMD;100UF,20%,16V,WT,TP,6.3X5.7MM	1	SA
....4	C438	2402-001128	C-AL,SMD;100UF,20%,16V,WT,TP,6.3X5.7MM	1	SA
....4	C446	2402-001128	C-AL,SMD;100UF,20%,16V,WT,TP,6.3X5.7MM	1	SA
....4	C550	2402-001128	C-AL,SMD;100UF,20%,16V,WT,TP,6.3X5.7MM	1	SA
....4	C603	2402-001128	C-AL,SMD;100UF,20%,16V,WT,TP,6.3X5.7MM	1	SA
....4	C606	2402-001128	C-AL,SMD;100UF,20%,16V,WT,TP,6.3X5.7MM	1	SA
....4	C558	2402-001155	C-AL,SMD;47UF,20%,16V,WT,TP,6.3X5.2MM	1	SA
....4	C351	2402-001178	C-AL,SMD;10uF,20%,16V,WT,TP,4.3x4.3x5.8m	1	SA
....4	C352	2402-001178	C-AL,SMD;10uF,20%,16V,WT,TP,4.3x4.3x5.8m	1	SA
....4	C538	2402-001178	C-AL,SMD;10uF,20%,16V,WT,TP,4.3x4.3x5.8m	1	SA
....4	C556	2402-001178	C-AL,SMD;10uF,20%,16V,WT,TP,4.3x4.3x5.8m	1	SA
....4	C557	2402-001178	C-AL,SMD;10uF,20%,16V,WT,TP,4.3x4.3x5.8m	1	SA
....4	C200	2402-001183	C-AL,SMD;22UF,20%,16V,WT,TP,5.3X5.3X6MM	1	SA
....4	C214	2402-001183	C-AL,SMD;22UF,20%,16V,WT,TP,5.3X5.3X6MM	1	SA
....4	C523	2402-001183	C-AL,SMD;22UF,20%,16V,WT,TP,5.3X5.3X6MM	1	SA

Level	Loc. No.	Code No.	Description & Specification	Q'ty	SA/SNA
....4	C560	2402-001218	C-AL,SMD;22UF,20%,35V,WT,TP,6.6X6.6X5.8M	1	S.A
....4	C213	2402-001238	C-AL,SMD;1uF,20%,50V,HR,TP,4.3x4.3x5.2mm	1	S.A
....4	C205	2402-001257	C-AL,SMD;470uF,20%,16V,-,TP,8.3*10	1	S.A
....4	C206	2402-001257	C-AL,SMD;470uF,20%,16V,-,TP,8.3*10	1	S.A
....4	C418	2402-001273	C-AL,SMD;220uF,20%,35V,WT,REEL,10X10mm	1	S.A
....4	C433	2402-001273	C-AL,SMD;220uF,20%,35V,WT,REEL,10X10mm	1	S.A
....4	T0052	2703-000185	INDUCTOR-SMD;3.3uH,10%,2012	1	S.A
....4	T0052	2703-000185	INDUCTOR-SMD;3.3uH,10%,2012	1	S.A
....4	T0052	2703-000185	INDUCTOR-SMD;3.3uH,10%,2012	1	S.A
....4	T0052	2703-000185	INDUCTOR-SMD;3.3uH,10%,2012	1	S.A
....4	T0052	2703-000185	INDUCTOR-SMD;3.3uH,10%,2012	1	S.A
....4	T0052	2703-000185	INDUCTOR-SMD;3.3uH,10%,2012	1	S.A
....4	T0052	2703-000185	INDUCTOR-SMD;3.3uH,10%,2012	1	S.A
....4	T0052	2703-000398	INDUCTOR-SMD;10uH,10%,3225	1	S.A
....4	T0052	2703-000398	INDUCTOR-SMD;10uH,10%,3225	1	S.A
....4	T0052	2703-000417	INDUCTOR-SMD;220uH,5%,3225	1	S.A
....4	T0052	2703-001334	INDUCTOR-SMD;1.5uH,10%,2012	1	S.A
....4	T0052	2703-001426	INDUCTOR-SMD;680uH,20%,7070	1	S.A
....4	T0052	2703-001778	INDUCTOR-SMD;3.3uH,20%,3225	1	S.A
....4	T0052	2703-001778	INDUCTOR-SMD;3.3uH,20%,3225	1	S.A
....4	T0052	2703-001778	INDUCTOR-SMD;3.3uH,20%,3225	1	S.A
....4	T0052	2703-001778	INDUCTOR-SMD;3.3uH,20%,3225	1	S.A
....4	T0052	2703-001778	INDUCTOR-SMD;3.3uH,20%,3225	1	S.A
....4	T0052	2703-001778	INDUCTOR-SMD;3.3uH,20%,3225	1	S.A
....4	T0052	2703-001778	INDUCTOR-SMD;3.3uH,20%,3225	1	S.A
....4	T0052	2703-001778	INDUCTOR-SMD;3.3uH,20%,3225	1	S.A
....4	T0052	2703-002327	INDUCTOR-SMD;3.9uH,5%,3225	1	S.A
....4	X300	2801-003667	CRYSTAL-SMD;14.31818MHz,30ppm,28-AAN,16	1	S.A
....4	T0568	3301-001145	BEAD-SMD;60ohm,4516,TP,70ohm/45MHz,82ohm	1	S.N.A
....4	T0568	3301-001145	BEAD-SMD;60ohm,4516,TP,70ohm/45MHz,82ohm	1	S.N.A
....4	T0568	3301-001145	BEAD-SMD;60ohm,4516,TP,70ohm/45MHz,82ohm	1	S.N.A
....4	T0568	3301-001145	BEAD-SMD;60ohm,4516,TP,70ohm/45MHz,82ohm	1	S.N.A
....4	T0568	3301-001145	BEAD-SMD;60ohm,4516,TP,70ohm/45MHz,82ohm	1	S.N.A
....4	T0568	3301-001145	BEAD-SMD;60ohm,4516,TP,70ohm/45MHz,82ohm	1	S.N.A
....4	T0568	3301-001145	BEAD-SMD;60ohm,4516,TP,70ohm/45MHz,82ohm	1	S.N.A
....4	T0568	3301-001145	BEAD-SMD;60ohm,4516,TP,70ohm/45MHz,82ohm	1	S.N.A
....4	T0568	3301-001145	BEAD-SMD;60ohm,4516,TP,70ohm/45MHz,82ohm	1	S.N.A
....4	T0568	3301-001236	BEAD-SMD;60ohm,1608,-,-,-	1	S.N.A
....4	CN330	3711-005292	HEADER-BOARD TO CABLE;BOX,3P,1R,2MM,SMD-	1	S.A
....4	CN330	3711-005477	HEADER-BOARD TO CABLE;BOX,4P,1R,2mm,SMD-	1	S.A
....4	IC302	BN09-00021A	IC MICOM-A/V DECODER;SE967-LF,DVORAK,208	1	S.N.A
....4	T0010	BN27-00009A	COIL CHOKE;SMD 12X12X6,EOS,33UH,15%,-,0.	1	S.A
....4	T0010	BN27-00009A	COIL CHOKE;SMD 12X12X6,EOS,33UH,15%,-,0.	1	S.A
....4	T0010	BN27-00009A	COIL CHOKE;SMD 12X12X6,EOS,33UH,15%,-,0.	1	S.A
....4	T0077	BN41-00748A	PCB MAIN;DVORAK,FR-4,4,1.6T,181*120,DVOR	1	S.N.A
....4	D500	0403-001052	DIODE-ZENER;RD8.2MB,7.7-8.7V,200mW,SOT-2	1	S.A
....4	D501	0403-001052	DIODE-ZENER;RD8.2MB,7.7-8.7V,200mW,SOT-2	1	S.A
....4	D502	0403-001052	DIODE-ZENER;RD8.2MB,7.7-8.7V,200mW,SOT-2	1	S.A
....4	D503	0403-001052	DIODE-ZENER;RD8.2MB,7.7-8.7V,200mW,SOT-2	1	S.A
....4	T0085	1201-002136	IC-AUDIO AMP;LM4810,MSOP,8P,3x3mm,DUAL,-	1	S.A
....4	R599	2007-000097	R-CHIP;47Kohm,5%,1/10W,TP,1608	1	S.A
....4	R600	2007-000097	R-CHIP;47Kohm,5%,1/10W,TP,1608	1	S.A
....4	R353	2007-000643	R-CHIP;270ohm,5%,1/10W,TP,1608	1	S.A
....4	R354	2007-000643	R-CHIP;270ohm,5%,1/10W,TP,1608	1	S.A
....4	T0568	3301-001793	BEAD-SMD;18ohm,1608,-,TP,11.8ohm/37.6MHz	1	S.A
....4	T0568	3301-001793	BEAD-SMD;18ohm,1608,-,TP,11.8ohm/37.6MHz	1	S.A
....4	T0568	3301-001793	BEAD-SMD;18ohm,1608,-,TP,11.8ohm/37.6MHz	1	S.A
....4	CN330	3711-005499	HEADER-BOARD TO CABLE;BOX,8P,1R,1.25mm,S	1	S.A
....4	CN330	3711-005503	HEADER-BOARD TO CABLE;BOX,9P,1R,2mm,SMD-	1	S.A
....4	R607	2007-000096	R-CHIP;30Kohm,5%,1/10W,TP,1608	1	S.A
....4	C605	2402-000130	C-AL,SMD;2.2uF,20%,50V,GP,TP,4.3x4.3x5.	1	S.A
...3	T0562	6046-001013	STAND OFF;M3,L5,Ni PLT,SUM24L,#4-40	2	S.N.A
..2		BN61-02426B	BRACKET-SHIELD;LS20HABW,SPT,E,T 0.3	1	S.N.A
..2	M0006	BN96-03870B	ASSY SHIELD P-COVER;DVORAK17,SECC,0.8	1	S.A

6 Electrical Parts List

Level	Loc. No.	Code No.	Description & Specification	Q'ty	SA/SNA
...3		BN61-02429D	STUD-PEM;PNB,M2.8,D7,L20,ZPC(SIL),SUM24L	1	S.N.A
...3	M0140	BN63-01474A	FELT-STAND;VENICE 20°,FELT,T1.0,10,15	2	S.N.A
...3		BN63-01774A	SHIELD-INSULATOR;BI17/19BS,PET,T0.35	1	S.N.A
...3	M0107	BN63-02683A	SHIELD-COVER;DVORAK,SECC,0.8	1	S.N.A
...3	M0131	BN63-02860A	GASKET;Dvorak,Conductive Fabric,5mm,10mm	1	S.N.A
0.1	M0112	BN91-01136A	ASSY SHIELD;DVORAK 17,4:3	1	S.N.A
..2	T0081	6002-001294	SCREW-TAPPING;BH,+,-,M4,L16,ZPC(BLK)	3	S.A
..2	M0081	6003-000282	SCREW-TAPTITE;BH,+,-,B,M3,L8,ZPC(BLK),SW	4	S.N.A
..2	M0081	6003-000282	SCREW-TAPTITE;BH,+,-,B,M3,L8,ZPC(BLK),SW	4	S.N.A
..2	M2893	BN39-00752A	LEAD CONNECTOR;DVORAK,UL1571#30,UL/CSA,3	1	S.A
..2	M0174	BN44-00137B	IP BOARD;PWI1704SM(A),DVORAK,3.8mA,7.5mA	1	S.N.A
..2	T0514	BN61-02578A	BRACKET-SUPPORT;DVORAK,SECC,1.2	1	S.N.A
..2		BN63-02684A	SHIELD-LAMP;DVORAK,SPT,0.3	1	S.N.A
..2	M0524	BP39-00028A	CONNECT WIRE;BI17,19BS,UL1007#26,9P,80mm	1	S.A
..2	T0069	AA60-00091F	SPACER-FELT;-FELT,150X10,-,-,BLK,T0.5,-	1	S.N.A
0.1	M0003	BN92-01943A	ASSY BOX;LS17DOASS/EDC,741MP	1	S.N.A
..2	BOX	BN69-01435A	BOX-MONITOR;LS17DOA,SY-01,A FLUTE,A1,W44	1.02	S.N.A
..2	T0081	BN96-02895A	ASSY MISC P-HANDLE PACKING;ALL MODEL,BN6	1	S.N.A
...3	M0103	BN66-00007A	LEVER-TOP;ALL MODEL,LDPE,WHITE	1	S.N.A
...3	M0102	BN66-00008A	LEVER-BOTTOM;ALL MODEL,LDPE,WHITE	1	S.N.A
0.1	M0045	BN92-01945A	ASSY ACCESSORY;LS17DOASS/EDC	1	S.N.A
..2	T0074	BN59-00403B	REMOCON;MH17ES,TM75,160°55'22,S3C1860XP0	1	S.A
..2	M0013	BN96-02332D	ASSY STAND P-BASE;HA19AS/BS,HIPS,GR70 &	1	S.A
...3	M0081	6003-000282	SCREW-TAPTITE;BH,+,-,B,M3,L8,ZPC(BLK),SW	4	S.N.A
...3	T0524	6902-000389	BAG PE;T0.015/T0.5/T0.015,W350,L300,TRP,	1	S.N.A
...3		BN61-01235A	SUPPORT-BRKT BASE;MJ19AS/BS,SECC,T1.6	1	S.N.A
...3	CIS4	BN61-01717A	HOLDER-STAND;BIZET,NI PLT,CH,+M4,L11(5)	1	S.N.A
...3	T0004	BN63-01991B	COVER-STAND BASE;HA19AS/BS,HIPS,T2.5,BK2	1	S.N.A
...3		BN63-01992D	COVER-STAND TOP;HA19AS/BS,HIPS,T2.5,GR70	1	S.N.A
...3		BN68-00786F	MANUAL FLYER-QSG;Bizet Stand Manual,Sync	1	S.N.A
...3	T0132	BN73-00077A	RUBBER FOOT;MATISSE,BUMPON,*13.5,T2.0,6	4	S.N.A
..2	M0045	BN96-03963B	ASSY ACCESSORY;LS17DOASS/EDC	1	S.N.A
...3	T0268	3903-000042	CBF-POWER CORD;DT,EU,FP3/YES,IEC320 C13/	1	S.A
...3	T0524	6902-000110	BAG PE;T0.05,W250,L400,TRP,28,2,-	1	S.N.A
...3	ACCESSORY	BH68-70448A	CARD-01;TFT LCD,SRC,RUSSIA,S/W,120,W210*	1	S.N.A
...3	T0128	BN39-00061B	CBF SIGNAL-STEREO;MH15NS,1P,UL2851#26,20	1	S.A
...3	M0114	BN39-00244A	CBF SIGNAL;BU15AO(T541A),15P/15P,20276-N	1	S.A
...3	T0059	BN68-00907A	MANUAL FLYER-CARD;COMM,SAMSUNG,18 LANG,E	1	S.N.A
...3	M0215	BN96-03964A	ASSY MANUAL P-IB+QSG;741MP,941MP,Kor,Kor	1	S.N.A
....4	I/B	BN59-00566A	S/W DRIVER-00,IB;741MP,941MP,W/W,PAL,Syn	1	S.N.A
....4	QSG	BN68-01071A	MANUAL FLYER-QSG;741MP,941MP,SyncMaster,	1	S.N.A
...3	T0238	BH68-00633A	MANUAL FLYER-WARRANTY CARD;comm,Samsung,	1	S.N.A
0.1	M0019	BN92-01946B	ASSY LABEL;LS17DOASS/EDC	1	S.N.A
0.1	M0113	BN92-01947A	ASSY P/MATERIAL;LS17DOASS/EDC,YES	1	S.N.A
..2	T0376	6902-000061	BAG AIR;T0.2,W500,L1000,TRP,-,-,-	0.006	S.N.A
..2	T0376	6902-000379	BAG AIR;T0.2,W1000,L1800,TRP,-,-,-	0.001	S.N.A
..2	T0081	6902-000604	BAG WRAPPING;T0.02,W500,L10000,TRP,-,-,-	0.94	S.N.A
..2	M0081	6902-000609	BAG ROLL;T0.05,W2400,L1000,TRP,-,-,-	0.032	S.N.A
..2	T0524	6902-000241	BAG PE;T0.5/T0.012,W600,L600,WHT,28,4,-	1	S.N.A

6-2 LS19DOA Parts List

Level	Loc. No.	Code No.	Description & Specification	Q'ty	SA/SNA
		LS19DOASS/EDC	941MP,SAF1/S19B5-LDO,19,LCD-MO,NETHERLAN		
0.1	M0216	BN90-00814A	ASSY STAND;LS19DOWSS/XAA,DO19WS	1	S.N.A
..2	STD	BN96-02966A	ASSY STAND P-BODY;LS19DOW,HIPS HB,BK24,Z	1	S.A
...3	M0081	6003-000275	SCREW-TAPTITE;BH,+,-,B,M3,L10,ZPC(BLK),S	4	S.N.A
...3		BN63-02128A	COVER-STAND FRONT;LS19DOW,HIPS,T2.5,HB,B	1	S.N.A
...3		BN63-02129A	COVER-STAND REAR;LS19DOW,HIPS,T2.5,HB,BK	1	S.N.A
...3	T0054	BN96-02967A	ASSY HINGE P;LS19DOW,ZNDC	1	S.N.A
0.1	M0001	BN90-01010A	ASSY COVER FRONT;DVORAK 19,4:3	1	S.N.A
..2	T0003	BN96-03872B	ASSY COVER P-FRONT;DVORAK 19",ABS HB,GR7	1	S.A
...3	M0081	6003-000282	SCREW-TAPTITE;BH,+,-,B,M3,L8,ZPC(BLK),SW	3	S.N.A
...3	M0081	6006-001096	SCREW-TAPTITE;BH,+,-,WP,B,M4.0,L12,ZPC(BLK)	4	S.N.A
...3	T0069	AA60-00171E	SPACER-FELT;43L2,FELT,300,T0.5,5	4	S.N.A
...3	M0112	BN63-02677A	COVER-FRONT;DVORAK,ABS,HB,GR70	1	S.N.A
...3	T0059	BN64-00506A	INDICATOR LED;DVORAK,ACRYL,CLR	1	S.N.A
...3	T0022	BN64-00507A	KNOB-CONTROL;DVORAK,ABS,HB,GR70	1	S.N.A
...3	T0175	BN96-03733A	ASSY SPEAKER P;16#Ø,Dvorak, 19, VE Type,	1	S.A
...3	T0175	BN96-03734A	ASSY SPEAKER P;16#Ø,Dvorak, 19, VE Type,	1	S.A
...3	M0145	BN96-03847A	ASSY BOARD P-FUNCTION IR;DVORAK,SJ06-01-	1	S.N.A
0.1	M0002	BN90-01011A	ASSY COVER REAR;DVORAK 19,4:3	1	S.N.A
..2	M0013	BN96-03873A	ASSY COVER P-REAR;DVORAK 19",HIPS HB,BK2	1	S.A
...3	M0113	BN61-01581A	BRACKET-VESA;BI17/19BS,SECC,T1.0	2	S.N.A
...3	M0006	BN63-02678A	COVER-REAR;DVORAK,HIPS,HB,BK24	1	S.N.A
0.1	M0106	BN91-00841R	ASSY LCD-STZ;LS19BIC*	1	S.N.A
..2	M0215	BN07-00222A	LCD-PANEL;LTM190EX-L21,Haydn,6BIT FRC,39	1	S.A
0.1	M0017	BN91-01133A	ASSY CHASSIS-STZ;LS19DOASS/EDC	1	S.A
..2	M0081	6003-000282	SCREW-TAPTITE;BH,+,-,B,M3,L8,ZPC(BLK),SW	3	S.N.A
..2	M0081	6003-001439	SCREW-TAPTITE;BH,+,-,S,M4,L8,ZPC(YEL)	1	S.N.A
..2		BN61-02577A	HOLDER-JACK;DVORAK,ABS,BK24,V0	1	S.N.A
..2	T0376	BN63-02134A	SHIELD-VIDEO;LS19DOW,SPT,TO.2	1	S.N.A
..2	M0014	BN94-01038A	ASSY PCB MAIN-STZ;LS19DOASS/EDC	1	S.N.A
...3	SUB05	0202-001477	SOLDER-CREAM;LST309-M,-,D20-45\$,96.5Sn/	0.599	S.N.A
...3	T0245	0202-001522	SOLDER-WIRE FLUX;LFA3-107,-,D1.2,96.5Sn/	0.003	S.N.A
...3	CN100	3701-001219	CONNECTOR-DSUB;15P,3R,FEMALE,ANGLE,AUF	1	S.A
...3	CN300	3711-005884	HEADER-BOARD TO BOARD;BOX,30P,2R,2mm,ANG	1	S.A
...3	JA330	3722-000143	JACK-PHONE;1P(VER),AG,BLK,ANGLE	1	S.A
...3	CN500	3722-000183	JACK-SCART;21P,SN,BLK	1	S.A
...3	CN501	3722-002081	JACK-EAR PHONE;5P/2C,-,SnPb,L-BLU,-	1	S.A
...3	JA333	3722-002267	JACK-PIN;3P,AU,RED/WHT/YEL,ANGLE	1	S.A
...3	CN200	3722-002275	JACK-DIN;4P,-,SN,BLK,-	1	S.A
...3	CIS3	BN40-00093A	TUNER;VFT-6C/W235S,VFT-6C/W235S,PAL B/G,	1	S.A
...3	MAIN	BN97-01100B	ASSY MICOM-MAIN;LS19DOASS/EDC,W/W	1	S.N.A
....4	IC115	1107-001580	IC-FLASH MEMORY;MX25L4005,4Mbit,512Kx8Bi	1	S.N.A
...3	T0174	BN97-01102A	ASSY SMD;LS19DOASS/EDC	1	S.N.A
....4	D100	0401-001056	DIODE-SWITCHING;MMBD4148SE,100V,200mA,SO	1	S.A
....4	D101	0401-001056	DIODE-SWITCHING;MMBD4148SE,100V,200mA,SO	1	S.A
....4	D102	0401-001056	DIODE-SWITCHING;MMBD4148SE,100V,200mA,SO	1	S.A
....4	D201	0401-001056	DIODE-SWITCHING;MMBD4148SE,100V,200mA,SO	1	S.A
....4	D516	0401-001056	DIODE-SWITCHING;MMBD4148SE,100V,200mA,SO	1	S.A
....4	D517	0401-001056	DIODE-SWITCHING;MMBD4148SE,100V,200mA,SO	1	S.A
....4	D518	0401-001056	DIODE-SWITCHING;MMBD4148SE,100V,200mA,SO	1	S.A
....4	D519	0401-001056	DIODE-SWITCHING;MMBD4148SE,100V,200mA,SO	1	S.A
....4	D523	0401-001056	DIODE-SWITCHING;MMBD4148SE,100V,200mA,SO	1	S.A
....4	D300	0401-001099	DIODE-SWITCHING;1N4148WS,75V,150mA,SOD-3	1	S.A
....4	D400	0402-000553	DIODE-SCHOTTKY;SS24/B240,40V,2000mA,DO-2	1	S.A
....4	D401	0402-001098	DIODE-RECTIFIER;SK34,40V,3A,SMC,TP	1	S.A
....4	D402	0402-001098	DIODE-RECTIFIER;SK34,40V,3A,SMC,TP	1	S.A
....4	ZD100	0403-000258	DIODE-ZENER;BZX84C5V6.5,2-6V,225mW,SOT-2	1	S.A
....4	ZD101	0403-000258	DIODE-ZENER;BZX84C5V6.5,2-6V,225mW,SOT-2	1	S.A

6 Electrical Parts List

Level	Loc. No.	Code No.	Description & Specification	Q'ty	SA/SNA
....4	ZD102	0403-000258	DIODE-ZENER;BZX84C5V6,5.2-6V,225mW,SOT-2	1	S.A
....4	D103	0403-000579	DIODE-ZENER;BZX84C5V1,4.8-5.4V,200mW,SOT	1	S.A
....4	D104	0403-000579	DIODE-ZENER;BZX84C5V1,4.8-5.4V,200mW,SOT	1	S.A
....4	D105	0403-000579	DIODE-ZENER;BZX84C5V1,4.8-5.4V,200mW,SOT	1	S.A
....4	D106	0403-000579	DIODE-ZENER;BZX84C5V1,4.8-5.4V,200mW,SOT	1	S.A
....4	D107	0403-000579	DIODE-ZENER;BZX84C5V1,4.8-5.4V,200mW,SOT	1	S.A
....4	D108	0403-000579	DIODE-ZENER;BZX84C5V1,4.8-5.4V,200mW,SOT	1	S.A
....4	D109	0403-000579	DIODE-ZENER;BZX84C5V1,4.8-5.4V,200mW,SOT	1	S.A
....4	D200	0403-001425	DIODE-ZENER;BZX84C33,31-35V,350mW,SOT-23	1	S.A
....4	D110	0403-001435	DIODE-ZENER;QZX363C5V6,5.32-5.88V,200MW,	1	S.A
....4	D202	0406-001163	DIODE-TVS;CDS3C05GTA,6.4V/-/-,SMD	1	S.A
....4	D203	0406-001163	DIODE-TVS;CDS3C05GTA,6.4V/-/-,SMD	1	S.A
....4	D504	0406-001163	DIODE-TVS;CDS3C05GTA,6.4V/-/-,SMD	1	S.A
....4	D505	0406-001163	DIODE-TVS;CDS3C05GTA,6.4V/-/-,SMD	1	S.A
....4	D506	0406-001163	DIODE-TVS;CDS3C05GTA,6.4V/-/-,SMD	1	S.A
....4	D507	0406-001163	DIODE-TVS;CDS3C05GTA,6.4V/-/-,SMD	1	S.A
....4	D508	0406-001163	DIODE-TVS;CDS3C05GTA,6.4V/-/-,SMD	1	S.A
....4	D509	0406-001163	DIODE-TVS;CDS3C05GTA,6.4V/-/-,SMD	1	S.A
....4	D510	0406-001163	DIODE-TVS;CDS3C05GTA,6.4V/-/-,SMD	1	S.A
....4	D511	0406-001163	DIODE-TVS;CDS3C05GTA,6.4V/-/-,SMD	1	S.A
....4	D512	0406-001163	DIODE-TVS;CDS3C05GTA,6.4V/-/-,SMD	1	S.A
....4	D513	0406-001163	DIODE-TVS;CDS3C05GTA,6.4V/-/-,SMD	1	S.A
....4	D514	0406-001163	DIODE-TVS;CDS3C05GTA,6.4V/-/-,SMD	1	S.A
....4	D515	0406-001163	DIODE-TVS;CDS3C05GTA,6.4V/-/-,SMD	1	S.A
....4	D522	0407-000123	DIODE-ARRAY;DAN202K,80V,100mA,CA2-3,SOT-	1	S.A
....4	Q503	0501-000280	TR-SMALL SIGNAL;KSA1182,PNP,150MW,SOT-23	1	S.A
....4	Q101	0501-000342	TR-SMALL SIGNAL;KSC1623-Y,NPN,200mW,SOT-	1	S.A
....4	Q102	0501-000342	TR-SMALL SIGNAL;KSC1623-Y,NPN,200mW,SOT-	1	S.A
....4	Q200	0501-000342	TR-SMALL SIGNAL;KSC1623-Y,NPN,200mW,SOT-	1	S.A
....4	Q502	0501-000342	TR-SMALL SIGNAL;KSC1623-Y,NPN,200mW,SOT-	1	S.A
....4	Q507	0501-000342	TR-SMALL SIGNAL;KSC1623-Y,NPN,200mW,SOT-	1	S.A
....4	Q400	0501-002080	TR-SMALL SIGNAL;2SC2412K,NPN,200mW,SC-59	1	S.A
....4	Q401	0501-002080	TR-SMALL SIGNAL;2SC2412K,NPN,200mW,SC-59	1	S.A
....4	Q402	0501-002080	TR-SMALL SIGNAL;2SC2412K,NPN,200mW,SC-59	1	S.A
....4	Q403	0501-002080	TR-SMALL SIGNAL;2SC2412K,NPN,200mW,SC-59	1	S.A
....4	Q404	0501-002080	TR-SMALL SIGNAL;2SC2412K,NPN,200mW,SC-59	1	S.A
....4	Q500	0501-002080	TR-SMALL SIGNAL;2SC2412K,NPN,200mW,SC-59	1	S.A
....4	Q501	0501-002080	TR-SMALL SIGNAL;2SC2412K,NPN,200mW,SC-59	1	S.A
....4	Q409	0505-001170	FET-SILICON;SI9933ADY-T1,P,-20V,3.4A,0.0	1	S.A
....4	Q409	0505-001170	FET-SILICON;SI9933ADY-T1,P,-20V,3.4A,0.0	1	S.A
....4	IC107	1002-001399	IC-D/A CONVERTER;PCM1754,24BIT,SSOP,16P,	1	S.A
....4	IC112	1103-000129	IC-EEPROM;24C02,2Kbit,256x8Bit,SOP,8P,5x	1	S.A
....4	IC112	1103-001279	IC-EEPROM;24C32,32Kbit,4Kx8Bit,SOP,8P,5x	1	S.A
....4	T0085	1201-001980	IC-AUDIO AMP;TDA7266D,SO,20P,16X11.1MM,-	1	S.A
....4	T0087	1203-002842	IC-POSI.FIXED REG.;AP1117D-33A,TO-252,3P	1	S.A
....4	IC405	1203-003015	IC-DC/DC CONVERTER;MP1410ES,SOIC,8P,4.9x	1	S.A
....4	T0170	1203-003059	IC-SWITCH VOL. REG.;MP1583,SOIC,8P,4.9x3	1	S.A
....4	T0170	1203-003059	IC-SWITCH VOL. REG.;MP1583,SOIC,8P,4.9x3	1	S.A
....4	T0087	1203-003952	IC-POSI.FIXED REG.;KA7805ERTM,DPAK,3P,6.	1	S.A
....4	R105	2007-000043	R-CHIP;1Kohm,1%,1/10W,TP,1608	1	S.A
....4	R108	2007-000043	R-CHIP;1Kohm,1%,1/10W,TP,1608	1	S.A
....4	R132	2007-000043	R-CHIP;1Kohm,1%,1/10W,TP,1608	1	S.A
....4	R133	2007-000043	R-CHIP;1Kohm,1%,1/10W,TP,1608	1	S.A
....4	R313	2007-000052	R-CHIP;10Kohm,1%,1/10W,TP,1608	1	S.A
....4	R335	2007-000052	R-CHIP;10Kohm,1%,1/10W,TP,1608	1	S.A
....4	R401	2007-000052	R-CHIP;10Kohm,1%,1/10W,TP,1608	1	S.A
....4	R421	2007-000067	R-CHIP;15Kohm,1%,1/10W,TP,1608	1	S.A
....4	R106	2007-000070	R-CHIP;0ohm,5%,1/10W,TP,1608	1	S.A
....4	R109	2007-000070	R-CHIP;0ohm,5%,1/10W,TP,1608	1	S.A
....4	R115	2007-000070	R-CHIP;0ohm,5%,1/10W,TP,1608	1	S.A
....4	R116	2007-000070	R-CHIP;0ohm,5%,1/10W,TP,1608	1	S.A
....4	R118	2007-000070	R-CHIP;0ohm,5%,1/10W,TP,1608	1	S.A
....4	R119	2007-000070	R-CHIP;0ohm,5%,1/10W,TP,1608	1	S.A

6 Electrical Parts List

Level	Loc. No.	Code No.	Description & Specification	Q'ty	SA/SNA
....4	R343	2007-000074	R-CHIP;100ohm,5%,1/10W,TP,1608	1	SA
....4	R351	2007-000074	R-CHIP;100ohm,5%,1/10W,TP,1608	1	SA
....4	R352	2007-000074	R-CHIP;100ohm,5%,1/10W,TP,1608	1	SA
....4	R402	2007-000074	R-CHIP;100ohm,5%,1/10W,TP,1608	1	SA
....4	R581	2007-000074	R-CHIP;100ohm,5%,1/10W,TP,1608	1	SA
....4	R584	2007-000074	R-CHIP;100ohm,5%,1/10W,TP,1608	1	SA
....4	R606	2007-000074	R-CHIP;100ohm,5%,1/10W,TP,1608	1	SA
....4	R200	2007-000076	R-CHIP;330ohm,5%,1/10W,TP,1608	1	SA
....4	R518	2007-000077	R-CHIP;470ohm,5%,1/10W,TP,1608	1	SA
....4	R214	2007-000078	R-CHIP;1Kohm,5%,1/10W,TP,1608	1	SA
....4	R409	2007-000078	R-CHIP;1Kohm,5%,1/10W,TP,1608	1	SA
....4	R415	2007-000078	R-CHIP;1Kohm,5%,1/10W,TP,1608	1	SA
....4	R423	2007-000078	R-CHIP;1Kohm,5%,1/10W,TP,1608	1	SA
....4	R539	2007-000078	R-CHIP;1Kohm,5%,1/10W,TP,1608	1	SA
....4	R540	2007-000078	R-CHIP;1Kohm,5%,1/10W,TP,1608	1	SA
....4	R542	2007-000078	R-CHIP;1Kohm,5%,1/10W,TP,1608	1	SA
....4	R110	2007-000080	R-CHIP;2Kohm,5%,1/10W,TP,1608	1	SA
....4	R111	2007-000081	R-CHIP;2.7Kohm,5%,1/10W,TP,1608	1	SA
....4	R514	2007-000081	R-CHIP;2.7Kohm,5%,1/10W,TP,1608	1	SA
....4	R101	2007-000084	R-CHIP;4.7Kohm,5%,1/10W,TP,1608	1	SA
....4	R102	2007-000084	R-CHIP;4.7Kohm,5%,1/10W,TP,1608	1	SA
....4	R130	2007-000084	R-CHIP;4.7Kohm,5%,1/10W,TP,1608	1	SA
....4	R131	2007-000084	R-CHIP;4.7Kohm,5%,1/10W,TP,1608	1	SA
....4	R302	2007-000084	R-CHIP;4.7Kohm,5%,1/10W,TP,1608	1	SA
....4	R303	2007-000084	R-CHIP;4.7Kohm,5%,1/10W,TP,1608	1	SA
....4	R315	2007-000084	R-CHIP;4.7Kohm,5%,1/10W,TP,1608	1	SA
....4	R316	2007-000084	R-CHIP;4.7Kohm,5%,1/10W,TP,1608	1	SA
....4	R317	2007-000084	R-CHIP;4.7Kohm,5%,1/10W,TP,1608	1	SA
....4	R318	2007-000084	R-CHIP;4.7Kohm,5%,1/10W,TP,1608	1	SA
....4	R319	2007-000084	R-CHIP;4.7Kohm,5%,1/10W,TP,1608	1	SA
....4	R344	2007-000084	R-CHIP;4.7Kohm,5%,1/10W,TP,1608	1	SA
....4	R349	2007-000084	R-CHIP;4.7Kohm,5%,1/10W,TP,1608	1	SA
....4	R350	2007-000084	R-CHIP;4.7Kohm,5%,1/10W,TP,1608	1	SA
....4	R400	2007-000084	R-CHIP;4.7Kohm,5%,1/10W,TP,1608	1	SA
....4	R405	2007-000084	R-CHIP;4.7Kohm,5%,1/10W,TP,1608	1	SA
....4	R414	2007-000084	R-CHIP;4.7Kohm,5%,1/10W,TP,1608	1	SA
....4	R605	2007-000084	R-CHIP;4.7Kohm,5%,1/10W,TP,1608	1	SA
....4	R408	2007-000087	R-CHIP;6.8Kohm,5%,1/10W,TP,1608	1	SA
....4	R424	2007-000087	R-CHIP;6.8Kohm,5%,1/10W,TP,1608	1	SA
....4	R100	2007-000090	R-CHIP;10Kohm,5%,1/10W,TP,1608	1	SA
....4	R103	2007-000090	R-CHIP;10Kohm,5%,1/10W,TP,1608	1	SA
....4	R112	2007-000090	R-CHIP;10Kohm,5%,1/10W,TP,1608	1	SA
....4	R125	2007-000090	R-CHIP;10Kohm,5%,1/10W,TP,1608	1	SA
....4	R135	2007-000090	R-CHIP;10Kohm,5%,1/10W,TP,1608	1	SA
....4	R136	2007-000090	R-CHIP;10Kohm,5%,1/10W,TP,1608	1	SA
....4	R410	2007-000090	R-CHIP;10Kohm,5%,1/10W,TP,1608	1	SA
....4	R412	2007-000090	R-CHIP;10Kohm,5%,1/10W,TP,1608	1	SA
....4	R416	2007-000090	R-CHIP;10Kohm,5%,1/10W,TP,1608	1	SA
....4	R425	2007-000090	R-CHIP;10Kohm,5%,1/10W,TP,1608	1	SA
....4	R512	2007-000090	R-CHIP;10Kohm,5%,1/10W,TP,1608	1	SA
....4	R523	2007-000090	R-CHIP;10Kohm,5%,1/10W,TP,1608	1	SA
....4	R524	2007-000090	R-CHIP;10Kohm,5%,1/10W,TP,1608	1	SA
....4	R525	2007-000090	R-CHIP;10Kohm,5%,1/10W,TP,1608	1	SA
....4	R530	2007-000090	R-CHIP;10Kohm,5%,1/10W,TP,1608	1	SA
....4	R531	2007-000090	R-CHIP;10Kohm,5%,1/10W,TP,1608	1	SA
....4	R537	2007-000090	R-CHIP;10Kohm,5%,1/10W,TP,1608	1	SA
....4	R538	2007-000090	R-CHIP;10Kohm,5%,1/10W,TP,1608	1	SA
....4	R541	2007-000090	R-CHIP;10Kohm,5%,1/10W,TP,1608	1	SA
....4	R561	2007-000090	R-CHIP;10Kohm,5%,1/10W,TP,1608	1	SA
....4	R562	2007-000090	R-CHIP;10Kohm,5%,1/10W,TP,1608	1	SA
....4	R563	2007-000090	R-CHIP;10Kohm,5%,1/10W,TP,1608	1	SA
....4	R564	2007-000090	R-CHIP;10Kohm,5%,1/10W,TP,1608	1	SA
....4	R566	2007-000090	R-CHIP;10Kohm,5%,1/10W,TP,1608	1	SA

Level	Loc. No.	Code No.	Description & Specification	Q'ty	SA/SNA
....4	R568	2007-000090	R-CHIP;10Kohm,5%,1/10W,TP,1608	1	SA
....4	R571	2007-000090	R-CHIP;10Kohm,5%,1/10W,TP,1608	1	SA
....4	R575	2007-000090	R-CHIP;10Kohm,5%,1/10W,TP,1608	1	SA
....4	R576	2007-000090	R-CHIP;10Kohm,5%,1/10W,TP,1608	1	SA
....4	R597	2007-000090	R-CHIP;10Kohm,5%,1/10W,TP,1608	1	SA
....4	R598	2007-000090	R-CHIP;10Kohm,5%,1/10W,TP,1608	1	SA
....4	R601	2007-000090	R-CHIP;10Kohm,5%,1/10W,TP,1608	1	SA
....4	R602	2007-000090	R-CHIP;10Kohm,5%,1/10W,TP,1608	1	SA
....4	R608	2007-000090	R-CHIP;10Kohm,5%,1/10W,TP,1608	1	SA
....4	R137	2007-000091	R-CHIP;12Kohm,5%,1/10W,TP,1608	1	SA
....4	R138	2007-000091	R-CHIP;12Kohm,5%,1/10W,TP,1608	1	SA
....4	R570	2007-000093	R-CHIP;20Kohm,5%,1/10W,TP,1608	1	SA
....4	R201	2007-000094	R-CHIP;22Kohm,5%,1/10W,TP,1608	1	SA
....4	R590	2007-000094	R-CHIP;22Kohm,5%,1/10W,TP,1608	1	SA
....4	R591	2007-000094	R-CHIP;22Kohm,5%,1/10W,TP,1608	1	SA
....4	R202	2007-000102	R-CHIP;100Kohm,5%,1/10W,TP,1608	1	SA
....4	R403	2007-000102	R-CHIP;100Kohm,5%,1/10W,TP,1608	1	SA
....4	R406	2007-000102	R-CHIP;100Kohm,5%,1/10W,TP,1608	1	SA
....4	R407	2007-000102	R-CHIP;100Kohm,5%,1/10W,TP,1608	1	SA
....4	R596	2007-000102	R-CHIP;100Kohm,5%,1/10W,TP,1608	1	SA
....4	R569	2007-000103	R-CHIP;120Kohm,5%,1/10W,TP,1608	1	SA
....4	R205	2007-000106	R-CHIP;220Kohm,5%,1/10W,TP,1608	1	SA
....4	R311	2007-000107	R-CHIP;470Kohm,5%,1/10W,TP,1608	1	SA
....4	R326	2007-000118	R-CHIP;390ohm,5%,1/10W,TP,1608	1	SA
....4	R520	2007-000458	R-CHIP;18Kohm,5%,1/10W,TP,1608	1	SA
....4	R418	2007-000708	R-CHIP;3.9Kohm,1%,1/10W,TP,1608	1	SA
....4	R404	2007-000913	R-CHIP;43Kohm,5%,1/10W,TP,1608	1	SA
....4	R411	2007-000965	R-CHIP;5.1Kohm,5%,1/10W,TP,1608	1	SA
....4	R419	2007-000965	R-CHIP;5.1Kohm,5%,1/10W,TP,1608	1	SA
....4	R422	2007-000965	R-CHIP;5.1Kohm,5%,1/10W,TP,1608	1	SA
....4	R420	2007-001068	R-CHIP;6.8Kohm,1%,1/10W,TP,1608	1	SA
....4	R122	2007-001164	R-CHIP;75ohm,1%,1/10W,TP,1608	1	SA
....4	R123	2007-001164	R-CHIP;75ohm,1%,1/10W,TP,1608	1	SA
....4	R124	2007-001164	R-CHIP;75ohm,1%,1/10W,TP,1608	1	SA
....4	R209	2007-001164	R-CHIP;75ohm,1%,1/10W,TP,1608	1	SA
....4	R532	2007-001164	R-CHIP;75ohm,1%,1/10W,TP,1608	1	SA
....4	R216	2007-001167	R-CHIP;75ohm,5%,1/10W,TP,1608	1	SA
....4	R217	2007-001167	R-CHIP;75ohm,5%,1/10W,TP,1608	1	SA
....4	R503	2007-001167	R-CHIP;75ohm,5%,1/10W,TP,1608	1	SA
....4	R504	2007-001167	R-CHIP;75ohm,5%,1/10W,TP,1608	1	SA
....4	R505	2007-001167	R-CHIP;75ohm,5%,1/10W,TP,1608	1	SA
....4	R506	2007-001167	R-CHIP;75ohm,5%,1/10W,TP,1608	1	SA
....4	R508	2007-001167	R-CHIP;75ohm,5%,1/10W,TP,1608	1	SA
....4	R516	2007-001167	R-CHIP;75ohm,5%,1/10W,TP,1608	1	SA
....4	R521	2007-001167	R-CHIP;75ohm,5%,1/10W,TP,1608	1	SA
....4	R522	2007-001167	R-CHIP;75ohm,5%,1/10W,TP,1608	1	SA
....4	R208	2007-002906	R-CHIP;200Kohm,1%,1/10W,TP,1608	1	SA
....4	R417	2007-007004	R-CHIP;12Kohm,1%,1/10W,TP,1608	1	SA
....4	R212	2007-007352	R-CHIP;130Kohm,1%,1/10W,TP,1608	1	SA
....4	RA300	2011-000881	R-NET;33ohm,5%,1/16W,L,CHIP,8P,TP,3.2x1.	1	SA
....4	RA301	2011-000881	R-NET;33ohm,5%,1/16W,L,CHIP,8P,TP,3.2x1.	1	SA
....4	RA302	2011-000881	R-NET;33ohm,5%,1/16W,L,CHIP,8P,TP,3.2x1.	1	SA
....4	RA303	2011-000881	R-NET;33ohm,5%,1/16W,L,CHIP,8P,TP,3.2x1.	1	SA
....4	RA304	2011-000881	R-NET;33ohm,5%,1/16W,L,CHIP,8P,TP,3.2x1.	1	SA
....4	C525	2203-000140	C-CER,CHIP;1.5nF,10%,50V,X7R,1608	1	SA
....4	C526	2203-000140	C-CER,CHIP;1.5nF,10%,50V,X7R,1608	1	SA
....4	C535	2203-000140	C-CER,CHIP;1.5nF,10%,50V,X7R,1608	1	SA
....4	C536	2203-000140	C-CER,CHIP;1.5nF,10%,50V,X7R,1608	1	SA
....4	C233	2203-000189	C-CER,CHIP;100nF,+80-20%,25V,Y5V,1608	1	SA
....4	C307	2203-000189	C-CER,CHIP;100nF,+80-20%,25V,Y5V,1608	1	SA
....4	C309	2203-000189	C-CER,CHIP;100nF,+80-20%,25V,Y5V,1608	1	SA
....4	C310	2203-000189	C-CER,CHIP;100nF,+80-20%,25V,Y5V,1608	1	SA
....4	C311	2203-000189	C-CER,CHIP;100nF,+80-20%,25V,Y5V,1608	1	SA

6 Electrical Parts List

Level	Loc. No.	Code No.	Description & Specification	Q'ty	SA/SNA
....4	C312	2203-000189	C-CER,CHIP;100nF,+80-20%,25V,Y5V,1608	1	SA
....4	C313	2203-000189	C-CER,CHIP;100nF,+80-20%,25V,Y5V,1608	1	SA
....4	C314	2203-000189	C-CER,CHIP;100nF,+80-20%,25V,Y5V,1608	1	SA
....4	C345	2203-000189	C-CER,CHIP;100nF,+80-20%,25V,Y5V,1608	1	SA
....4	C347	2203-000189	C-CER,CHIP;100nF,+80-20%,25V,Y5V,1608	1	SA
....4	C348	2203-000189	C-CER,CHIP;100nF,+80-20%,25V,Y5V,1608	1	SA
....4	C355	2203-000189	C-CER,CHIP;100nF,+80-20%,25V,Y5V,1608	1	SA
....4	C401	2203-000189	C-CER,CHIP;100nF,+80-20%,25V,Y5V,1608	1	SA
....4	C411	2203-000189	C-CER,CHIP;100nF,+80-20%,25V,Y5V,1608	1	SA
....4	C412	2203-000189	C-CER,CHIP;100nF,+80-20%,25V,Y5V,1608	1	SA
....4	C420	2203-000189	C-CER,CHIP;100nF,+80-20%,25V,Y5V,1608	1	SA
....4	C430	2203-000189	C-CER,CHIP;100nF,+80-20%,25V,Y5V,1608	1	SA
....4	C434	2203-000189	C-CER,CHIP;100nF,+80-20%,25V,Y5V,1608	1	SA
....4	C442	2203-000189	C-CER,CHIP;100nF,+80-20%,25V,Y5V,1608	1	SA
....4	C445	2203-000189	C-CER,CHIP;100nF,+80-20%,25V,Y5V,1608	1	SA
....4	C600	2203-000189	C-CER,CHIP;100nF,+80-20%,25V,Y5V,1608	1	SA
....4	C607	2203-000189	C-CER,CHIP;100nF,+80-20%,25V,Y5V,1608	1	SA
....4	C608	2203-000189	C-CER,CHIP;100nF,+80-20%,25V,Y5V,1608	1	SA
....4	C102	2203-000236	C-CER,CHIP;0.1nF,5%,50V,C0G,1608	1	SA
....4	C215	2203-000236	C-CER,CHIP;0.1nF,5%,50V,C0G,1608	1	SA
....4	C216	2203-000236	C-CER,CHIP;0.1nF,5%,50V,C0G,1608	1	SA
....4	C416	2203-000236	C-CER,CHIP;0.1nF,5%,50V,C0G,1608	1	SA
....4	C439	2203-000236	C-CER,CHIP;0.1nF,5%,50V,C0G,1608	1	SA
....4	C447	2203-000236	C-CER,CHIP;0.1nF,5%,50V,C0G,1608	1	SA
....4	C201	2203-000257	C-CER,CHIP;10nF,10%,50V,X7R,1608	1	SA
....4	C209	2203-000257	C-CER,CHIP;10nF,10%,50V,X7R,1608	1	SA
....4	C210	2203-000257	C-CER,CHIP;10nF,10%,50V,X7R,1608	1	SA
....4	C301	2203-000257	C-CER,CHIP;10nF,10%,50V,X7R,1608	1	SA
....4	C403	2203-000257	C-CER,CHIP;10nF,10%,50V,X7R,1608	1	SA
....4	C408	2203-000257	C-CER,CHIP;10nF,10%,50V,X7R,1608	1	SA
....4	C428	2203-000257	C-CER,CHIP;10nF,10%,50V,X7R,1608	1	SA
....4	C429	2203-000257	C-CER,CHIP;10nF,10%,50V,X7R,1608	1	SA
....4	C431	2203-000257	C-CER,CHIP;10nF,10%,50V,X7R,1608	1	SA
....4	C440	2203-000257	C-CER,CHIP;10nF,10%,50V,X7R,1608	1	SA
....4	C441	2203-000257	C-CER,CHIP;10nF,10%,50V,X7R,1608	1	SA
....4	C443	2203-000257	C-CER,CHIP;10nF,10%,50V,X7R,1608	1	SA
....4	C115	2203-000440	C-CER,CHIP;1nF,10%,50V,X7R,1608	1	SA
....4	C303	2203-000440	C-CER,CHIP;1nF,10%,50V,X7R,1608	1	SA
....4	C508	2203-000440	C-CER,CHIP;1nF,10%,50V,X7R,1608	1	SA
....4	C517	2203-000440	C-CER,CHIP;1nF,10%,50V,X7R,1608	1	SA
....4	C519	2203-000440	C-CER,CHIP;1nF,10%,50V,X7R,1608	1	SA
....4	C520	2203-000440	C-CER,CHIP;1nF,10%,50V,X7R,1608	1	SA
....4	C533	2203-000440	C-CER,CHIP;1nF,10%,50V,X7R,1608	1	SA
....4	C534	2203-000440	C-CER,CHIP;1nF,10%,50V,X7R,1608	1	SA
....4	C553	2203-000440	C-CER,CHIP;1nF,10%,50V,X7R,1608	1	SA
....4	C581	2203-000440	C-CER,CHIP;1nF,10%,50V,X7R,1608	1	SA
....4	C582	2203-000440	C-CER,CHIP;1nF,10%,50V,X7R,1608	1	SA
....4	C583	2203-000440	C-CER,CHIP;1nF,10%,50V,X7R,1608	1	SA
....4	C584	2203-000440	C-CER,CHIP;1nF,10%,50V,X7R,1608	1	SA
....4	C211	2203-000491	C-CER,CHIP;2.2nF,10%,50V,X7R,1608	1	SA
....4	C353	2203-000491	C-CER,CHIP;2.2nF,10%,50V,X7R,1608	1	SA
....4	C354	2203-000491	C-CER,CHIP;2.2nF,10%,50V,X7R,1608	1	SA
....4	C574	2203-000604	C-CER,CHIP;22nF,10%,25V,X7R,1608	1	SA
....4	C575	2203-000604	C-CER,CHIP;22nF,10%,25V,X7R,1608	1	SA
....4	C101	2203-000626	C-CER,CHIP;0.022nF,5%,50V,C0G,1608	1	SA
....4	C235	2203-000626	C-CER,CHIP;0.022nF,5%,50V,C0G,1608	1	SA
....4	C304	2203-000626	C-CER,CHIP;0.022nF,5%,50V,C0G,1608	1	SA
....4	C305	2203-000626	C-CER,CHIP;0.022nF,5%,50V,C0G,1608	1	SA
....4	C212	2203-000888	C-CER,CHIP;4.7nF,10%,50V,X7R,1608	1	SA
....4	C103	2203-000972	C-CER,CHIP;47nF,10%,16V,X7R,1608	1	SA
....4	C104	2203-000972	C-CER,CHIP;47nF,10%,16V,X7R,1608	1	SA
....4	C105	2203-000972	C-CER,CHIP;47nF,10%,16V,X7R,1608	1	SA
....4	C106	2203-000972	C-CER,CHIP;47nF,10%,16V,X7R,1608	1	SA

Level	Loc. No.	Code No.	Description & Specification	Q'ty	SA/SNA
....4	C107	2203-000972	C-CER,CHIP;47nF,10%,16V,X7R,1608	1	SA
....4	C108	2203-000972	C-CER,CHIP;47nF,10%,16V,X7R,1608	1	SA
....4	C202	2203-000972	C-CER,CHIP;47nF,10%,16V,X7R,1608	1	SA
....4	C217	2203-000972	C-CER,CHIP;47nF,10%,16V,X7R,1608	1	SA
....4	C218	2203-000972	C-CER,CHIP;47nF,10%,16V,X7R,1608	1	SA
....4	C219	2203-000972	C-CER,CHIP;47nF,10%,16V,X7R,1608	1	SA
....4	C232	2203-000972	C-CER,CHIP;47nF,10%,16V,X7R,1608	1	SA
....4	C236	2203-000972	C-CER,CHIP;47nF,10%,16V,X7R,1608	1	SA
....4	C237	2203-000972	C-CER,CHIP;47nF,10%,16V,X7R,1608	1	SA
....4	C238	2203-000972	C-CER,CHIP;47nF,10%,16V,X7R,1608	1	SA
....4	C504	2203-000972	C-CER,CHIP;47nF,10%,16V,X7R,1608	1	SA
....4	C505	2203-000972	C-CER,CHIP;47nF,10%,16V,X7R,1608	1	SA
....4	C506	2203-000972	C-CER,CHIP;47nF,10%,16V,X7R,1608	1	SA
....4	C507	2203-000972	C-CER,CHIP;47nF,10%,16V,X7R,1608	1	SA
....4	C509	2203-000972	C-CER,CHIP;47nF,10%,16V,X7R,1608	1	SA
....4	C511	2203-000972	C-CER,CHIP;47nF,10%,16V,X7R,1608	1	SA
....4	C512	2203-000972	C-CER,CHIP;47nF,10%,16V,X7R,1608	1	SA
....4	C531	2203-000972	C-CER,CHIP;47nF,10%,16V,X7R,1608	1	SA
....4	C532	2203-000972	C-CER,CHIP;47nF,10%,16V,X7R,1608	1	SA
....4	C400	2203-000975	C-CER,CHIP;47nF,10%,25V,X7R,TP,1608,-	1	SA
....4	C427	2203-000975	C-CER,CHIP;47nF,10%,25V,X7R,TP,1608,-	1	SA
....4	C500	2203-000998	C-CER,CHIP;0.047nF,5%,50V,C0G,1608	1	SA
....4	C501	2203-000998	C-CER,CHIP;0.047nF,5%,50V,C0G,1608	1	SA
....4	C502	2203-000998	C-CER,CHIP;0.047nF,5%,50V,C0G,1608	1	SA
....4	C503	2203-000998	C-CER,CHIP;0.047nF,5%,50V,C0G,1608	1	SA
....4	C513	2203-000998	C-CER,CHIP;0.047nF,5%,50V,C0G,1608	1	SA
....4	C514	2203-000998	C-CER,CHIP;0.047nF,5%,50V,C0G,1608	1	SA
....4	C515	2203-000998	C-CER,CHIP;0.047nF,5%,50V,C0G,1608	1	SA
....4	C112	2203-001071	C-CER,CHIP;0.056nF,5%,50V,C0G,1608	1	SA
....4	C208	2203-001607	C-CER,CHIP;0.22nF,5%,50V,NP0,1608	1	SA
....4	C409	2203-001652	C-CER,CHIP;470nF,+80-20%,16V,Y5V,1608	1	SA
....4	C421	2203-001652	C-CER,CHIP;470nF,+80-20%,16V,Y5V,1608	1	SA
....4	C422	2203-001652	C-CER,CHIP;470nF,+80-20%,16V,Y5V,1608	1	SA
....4	C350	2203-001724	C-CER,CHIP;4700nF,+80-20%,16V,Y5V,3216	1	SA
....4	C407	2203-002793	C-CER,CHIP;1000nF,+80-20%,25V,Y5V,2012	1	SA
....4	C100	2203-005005	C-CER,CHIP;100nF,10%,16V,X7R,1608	1	SA
....4	C204	2203-005005	C-CER,CHIP;100nF,10%,16V,X7R,1608	1	SA
....4	C207	2203-005005	C-CER,CHIP;100nF,10%,16V,X7R,1608	1	SA
....4	C414	2203-005005	C-CER,CHIP;100nF,10%,16V,X7R,1608	1	SA
....4	C425	2203-005005	C-CER,CHIP;100nF,10%,16V,X7R,1608	1	SA
....4	C426	2203-005005	C-CER,CHIP;100nF,10%,16V,X7R,1608	1	SA
....4	C435	2203-005005	C-CER,CHIP;100nF,10%,16V,X7R,1608	1	SA
....4	C437	2203-005005	C-CER,CHIP;100nF,10%,16V,X7R,1608	1	SA
....4	C554	2203-005005	C-CER,CHIP;100nF,10%,16V,X7R,1608	1	SA
....4	C580	2203-005005	C-CER,CHIP;100nF,10%,16V,X7R,1608	1	SA
....4	C109	2203-005065	C-CER,CHIP;1000nF,+80-20%,10V,Y5V,1608	1	SA
....4	C110	2203-005065	C-CER,CHIP;1000nF,+80-20%,10V,Y5V,1608	1	SA
....4	C111	2203-005065	C-CER,CHIP;1000nF,+80-20%,10V,Y5V,1608	1	SA
....4	C113	2203-005065	C-CER,CHIP;1000nF,+80-20%,10V,Y5V,1608	1	SA
....4	C114	2203-005065	C-CER,CHIP;1000nF,+80-20%,10V,Y5V,1608	1	SA
....4	C302	2203-005065	C-CER,CHIP;1000nF,+80-20%,10V,Y5V,1608	1	SA
....4	C315	2203-005065	C-CER,CHIP;1000nF,+80-20%,10V,Y5V,1608	1	SA
....4	C316	2203-005065	C-CER,CHIP;1000nF,+80-20%,10V,Y5V,1608	1	SA
....4	C317	2203-005065	C-CER,CHIP;1000nF,+80-20%,10V,Y5V,1608	1	SA
....4	C318	2203-005065	C-CER,CHIP;1000nF,+80-20%,10V,Y5V,1608	1	SA
....4	C319	2203-005065	C-CER,CHIP;1000nF,+80-20%,10V,Y5V,1608	1	SA
....4	C320	2203-005065	C-CER,CHIP;1000nF,+80-20%,10V,Y5V,1608	1	SA
....4	C321	2203-005065	C-CER,CHIP;1000nF,+80-20%,10V,Y5V,1608	1	SA
....4	C322	2203-005065	C-CER,CHIP;1000nF,+80-20%,10V,Y5V,1608	1	SA
....4	C323	2203-005065	C-CER,CHIP;1000nF,+80-20%,10V,Y5V,1608	1	SA
....4	C324	2203-005065	C-CER,CHIP;1000nF,+80-20%,10V,Y5V,1608	1	SA
....4	C325	2203-005065	C-CER,CHIP;1000nF,+80-20%,10V,Y5V,1608	1	SA
....4	C326	2203-005065	C-CER,CHIP;1000nF,+80-20%,10V,Y5V,1608	1	SA

6 Electrical Parts List

Level	Loc. No.	Code No.	Description & Specification	Q'ty	SA/SNA
....4	C327	2203-005065	C-CER,CHIP;1000nF,+80-20%,10V,Y5V,1608	1	SA
....4	C328	2203-005065	C-CER,CHIP;1000nF,+80-20%,10V,Y5V,1608	1	SA
....4	C329	2203-005065	C-CER,CHIP;1000nF,+80-20%,10V,Y5V,1608	1	SA
....4	C330	2203-005065	C-CER,CHIP;1000nF,+80-20%,10V,Y5V,1608	1	SA
....4	C331	2203-005065	C-CER,CHIP;1000nF,+80-20%,10V,Y5V,1608	1	SA
....4	C332	2203-005065	C-CER,CHIP;1000nF,+80-20%,10V,Y5V,1608	1	SA
....4	C333	2203-005065	C-CER,CHIP;1000nF,+80-20%,10V,Y5V,1608	1	SA
....4	C334	2203-005065	C-CER,CHIP;1000nF,+80-20%,10V,Y5V,1608	1	SA
....4	C335	2203-005065	C-CER,CHIP;1000nF,+80-20%,10V,Y5V,1608	1	SA
....4	C336	2203-005065	C-CER,CHIP;1000nF,+80-20%,10V,Y5V,1608	1	SA
....4	C337	2203-005065	C-CER,CHIP;1000nF,+80-20%,10V,Y5V,1608	1	SA
....4	C338	2203-005065	C-CER,CHIP;1000nF,+80-20%,10V,Y5V,1608	1	SA
....4	C339	2203-005065	C-CER,CHIP;1000nF,+80-20%,10V,Y5V,1608	1	SA
....4	C340	2203-005065	C-CER,CHIP;1000nF,+80-20%,10V,Y5V,1608	1	SA
....4	C341	2203-005065	C-CER,CHIP;1000nF,+80-20%,10V,Y5V,1608	1	SA
....4	C342	2203-005065	C-CER,CHIP;1000nF,+80-20%,10V,Y5V,1608	1	SA
....4	C343	2203-005065	C-CER,CHIP;1000nF,+80-20%,10V,Y5V,1608	1	SA
....4	C344	2203-005065	C-CER,CHIP;1000nF,+80-20%,10V,Y5V,1608	1	SA
....4	C346	2203-005065	C-CER,CHIP;1000nF,+80-20%,10V,Y5V,1608	1	SA
....4	C404	2203-005065	C-CER,CHIP;1000nF,+80-20%,10V,Y5V,1608	1	SA
....4	C405	2203-005065	C-CER,CHIP;1000nF,+80-20%,10V,Y5V,1608	1	SA
....4	C410	2203-005065	C-CER,CHIP;1000nF,+80-20%,10V,Y5V,1608	1	SA
....4	C448	2203-005065	C-CER,CHIP;1000nF,+80-20%,10V,Y5V,1608	1	SA
....4	C524	2203-005065	C-CER,CHIP;1000nF,+80-20%,10V,Y5V,1608	1	SA
....4	C602	2203-005065	C-CER,CHIP;1000nF,+80-20%,10V,Y5V,1608	1	SA
....4	C604	2203-005065	C-CER,CHIP;1000nF,+80-20%,10V,Y5V,1608	1	SA
....4	C578	2203-005261	C-CER,CHIP;1000nF,10%,25V,X7R,3216	1	SA
....4	C579	2203-005261	C-CER,CHIP;1000nF,10%,25V,X7R,3216	1	SA
....4	C423	2203-005437	C-CER,CHIP;10000nF,+80-20%,10V,Y5V,3216	1	SA
....4	C424	2203-005437	C-CER,CHIP;10000nF,+80-20%,10V,Y5V,3216	1	SA
....4	C432	2203-005437	C-CER,CHIP;10000nF,+80-20%,10V,Y5V,3216	1	SA
....4	C436	2203-005437	C-CER,CHIP;10000nF,+80-20%,10V,Y5V,3216	1	SA
....4	C601	2203-005437	C-CER,CHIP;10000nF,+80-20%,10V,Y5V,3216	1	SA
....4	C308	2203-006333	C-CER,CHIP;10000nF,20%,16V,X5R,TP,3216	1	SA
....4	C349	2203-006333	C-CER,CHIP;10000nF,20%,16V,X5R,TP,3216	1	SA
....4	C306	2402-000108	C-AL,SMD;10uF,20%,16V,WT,TP,4.3x4.3x5.2m	1	SA
....4	C406	2402-000108	C-AL,SMD;10uF,20%,16V,WT,TP,4.3x4.3x5.2m	1	SA
....4	C415	2402-001081	C-AL,SMD;100uF,20%,25V,WT,TP,8.3x8.3x10	1	SA
....4	C444	2402-001081	C-AL,SMD;100uF,20%,25V,WT,TP,8.3x8.3x10	1	SA
....4	C300	2402-001086	C-AL,SMD;100UF,20%,16V,WT,TP,6.6X6.6X5.3	1	SA
....4	C417	2402-001086	C-AL,SMD;100UF,20%,16V,WT,TP,6.6X6.6X5.3	1	SA
....4	C203	2402-001128	C-AL,SMD;100UF,20%,16V,WT,TP,6.3X5.7MM	1	SA
....4	C402	2402-001128	C-AL,SMD;100UF,20%,16V,WT,TP,6.3X5.7MM	1	SA
....4	C413	2402-001128	C-AL,SMD;100UF,20%,16V,WT,TP,6.3X5.7MM	1	SA
....4	C438	2402-001128	C-AL,SMD;100UF,20%,16V,WT,TP,6.3X5.7MM	1	SA
....4	C446	2402-001128	C-AL,SMD;100UF,20%,16V,WT,TP,6.3X5.7MM	1	SA
....4	C550	2402-001128	C-AL,SMD;100UF,20%,16V,WT,TP,6.3X5.7MM	1	SA
....4	C603	2402-001128	C-AL,SMD;100UF,20%,16V,WT,TP,6.3X5.7MM	1	SA
....4	C606	2402-001128	C-AL,SMD;100UF,20%,16V,WT,TP,6.3X5.7MM	1	SA
....4	C558	2402-001155	C-AL,SMD;47UF,20%,16V,WT,TP,6.3X5.2MM	1	SA
....4	C351	2402-001178	C-AL,SMD;10uF,20%,16V,WT,TP,4.3x4.3x5.8m	1	SA
....4	C352	2402-001178	C-AL,SMD;10uF,20%,16V,WT,TP,4.3x4.3x5.8m	1	SA
....4	C538	2402-001178	C-AL,SMD;10uF,20%,16V,WT,TP,4.3x4.3x5.8m	1	SA
....4	C556	2402-001178	C-AL,SMD;10uF,20%,16V,WT,TP,4.3x4.3x5.8m	1	SA
....4	C557	2402-001178	C-AL,SMD;10uF,20%,16V,WT,TP,4.3x4.3x5.8m	1	SA
....4	C200	2402-001183	C-AL,SMD;22UF,20%,16V,WT,TP,5.3X5.3X6MM	1	SA
....4	C214	2402-001183	C-AL,SMD;22UF,20%,16V,WT,TP,5.3X5.3X6MM	1	SA
....4	C523	2402-001183	C-AL,SMD;22UF,20%,16V,WT,TP,5.3X5.3X6MM	1	SA
....4	C560	2402-001218	C-AL,SMD;22UF,20%,35V,WT,TP,6.6X6.6X5.8M	1	SA
....4	C213	2402-001238	C-AL,SMD;1uF,20%,50V,HR,TP,4.3x4.3x5.2mm	1	SA
....4	C205	2402-001257	C-AL,SMD;470uF,20%,16V,-,TP,8.3*10	1	SA
....4	C206	2402-001257	C-AL,SMD;470uF,20%,16V,-,TP,8.3*10	1	SA
....4	C418	2402-001273	C-AL,SMD;220uF,20%,35V,WT,REEL,10X10mm	1	SA

Level	Loc. No.	Code No.	Description & Specification	Q'ty	SA/SNA
....4	C433	2402-001273	C-AL,SMD;220uF,20%,35V,WT,REEL,10X10mm	1	SA
....4	T0052	2703-000185	INDUCTOR-SMD;3.3uH,10%,2012	1	SA
....4	T0052	2703-000185	INDUCTOR-SMD;3.3uH,10%,2012	1	SA
....4	T0052	2703-000185	INDUCTOR-SMD;3.3uH,10%,2012	1	SA
....4	T0052	2703-000185	INDUCTOR-SMD;3.3uH,10%,2012	1	SA
....4	T0052	2703-000185	INDUCTOR-SMD;3.3uH,10%,2012	1	SA
....4	T0052	2703-000185	INDUCTOR-SMD;3.3uH,10%,2012	1	SA
....4	T0052	2703-000185	INDUCTOR-SMD;3.3uH,10%,2012	1	SA
....4	T0052	2703-000185	INDUCTOR-SMD;3.3uH,10%,2012	1	SA
....4	T0052	2703-000398	INDUCTOR-SMD;10uH,10%,3225	1	SA
....4	T0052	2703-000398	INDUCTOR-SMD;10uH,10%,3225	1	SA
....4	T0052	2703-000417	INDUCTOR-SMD;220uH,5%,3225	1	SA
....4	T0052	2703-001334	INDUCTOR-SMD;1.5uH,10%,2012	1	SA
....4	T0052	2703-001426	INDUCTOR-SMD;680uH,20%,7070	1	SA
....4	T0052	2703-001778	INDUCTOR-SMD;3.3uH,20%,3225	1	SA
....4	T0052	2703-001778	INDUCTOR-SMD;3.3uH,20%,3225	1	SA
....4	T0052	2703-001778	INDUCTOR-SMD;3.3uH,20%,3225	1	SA
....4	T0052	2703-001778	INDUCTOR-SMD;3.3uH,20%,3225	1	SA
....4	T0052	2703-001778	INDUCTOR-SMD;3.3uH,20%,3225	1	SA
....4	T0052	2703-001778	INDUCTOR-SMD;3.3uH,20%,3225	1	SA
....4	T0052	2703-001778	INDUCTOR-SMD;3.3uH,20%,3225	1	SA
....4	T0052	2703-001778	INDUCTOR-SMD;3.3uH,20%,3225	1	SA
....4	T0052	2703-001778	INDUCTOR-SMD;3.3uH,20%,3225	1	SA
....4	T0052	2703-002327	INDUCTOR-SMD;3.9uH,5%,3225	1	SA
....4	X300	2801-003667	CRYSTAL-SMD;14.31818MHz,30ppm,28-AAN,16,	1	SA
....4	T0568	3301-001145	BEAD-SMD;60ohm,4516,TP,70ohm/45MHz,82ohm	1	S.N.A
....4	T0568	3301-001145	BEAD-SMD;60ohm,4516,TP,70ohm/45MHz,82ohm	1	S.N.A
....4	T0568	3301-001145	BEAD-SMD;60ohm,4516,TP,70ohm/45MHz,82ohm	1	S.N.A
....4	T0568	3301-001145	BEAD-SMD;60ohm,4516,TP,70ohm/45MHz,82ohm	1	S.N.A
....4	T0568	3301-001145	BEAD-SMD;60ohm,4516,TP,70ohm/45MHz,82ohm	1	S.N.A
....4	T0568	3301-001145	BEAD-SMD;60ohm,4516,TP,70ohm/45MHz,82ohm	1	S.N.A
....4	T0568	3301-001145	BEAD-SMD;60ohm,4516,TP,70ohm/45MHz,82ohm	1	S.N.A
....4	T0568	3301-001145	BEAD-SMD;60ohm,4516,TP,70ohm/45MHz,82ohm	1	S.N.A
....4	T0568	3301-001236	BEAD-SMD;60ohm,1608,-,-,-	1	S.N.A
....4	CN330	3711-005292	HEADER-BOARD TO CABLE;BOX,3P,1R,2MM,SMD-	1	SA
....4	CN330	3711-005477	HEADER-BOARD TO CABLE;BOX,4P,1R,2mm,SMD-	1	SA
....4	IC302	BN09-00021A	IC MICOM-A/V DECODER;SE967-LF,DVORAK,208	1	S.N.A
....4	T0010	BN27-00009A	COIL CHOKE;SMD 12X12X6,EOS,33UH,15%,-,0.	1	SA
....4	T0010	BN27-00009A	COIL CHOKE;SMD 12X12X6,EOS,33UH,15%,-,0.	1	SA
....4	T0010	BN27-00009A	COIL CHOKE;SMD 12X12X6,EOS,33UH,15%,-,0.	1	SA
....4	T0077	BN41-00748A	PCB MAIN;DVORAK,FR-4,4,1.6T,181*120,DVOR	1	S.N.A
....4	D500	0403-001052	DIODE-ZENER;RD8.2MB,7.7-8.7V,200mW,SOT-2	1	SA
....4	D501	0403-001052	DIODE-ZENER;RD8.2MB,7.7-8.7V,200mW,SOT-2	1	SA
....4	D502	0403-001052	DIODE-ZENER;RD8.2MB,7.7-8.7V,200mW,SOT-2	1	SA
....4	D503	0403-001052	DIODE-ZENER;RD8.2MB,7.7-8.7V,200mW,SOT-2	1	SA
....4	T0085	1201-002136	IC-AUDIO AMP;LM4810,MSOP,8P,3x3mm,DUAL,-	1	SA
....4	R599	2007-000097	R-CHIP;47Kohm,5%,1/10W,TP,1608	1	SA
....4	R600	2007-000097	R-CHIP;47Kohm,5%,1/10W,TP,1608	1	SA
....4	R353	2007-000643	R-CHIP;270ohm,5%,1/10W,TP,1608	1	SA
....4	R354	2007-000643	R-CHIP;270ohm,5%,1/10W,TP,1608	1	SA
....4	T0568	3301-001793	BEAD-SMD;18ohm,1608,-,TP,11.8ohm/37.6MHz	1	SA
....4	T0568	3301-001793	BEAD-SMD;18ohm,1608,-,TP,11.8ohm/37.6MHz	1	SA
....4	T0568	3301-001793	BEAD-SMD;18ohm,1608,-,TP,11.8ohm/37.6MHz	1	SA
....4	CN330	3711-005499	HEADER-BOARD TO CABLE;BOX,8P,1R,1.25mm,S	1	SA
....4	CN330	3711-005503	HEADER-BOARD TO CABLE;BOX,9P,1R,2mm,SMD-	1	SA
....4	R607	2007-000096	R-CHIP;30Kohm,5%,1/10W,TP,1608	1	SA
....4	C605	2402-000130	C-AL,SMD;2.2uF,20%,50V,GP,TP,4.3x4.3x5.	1	SA
...3	T0562	6046-001013	STAND OFF;M3,L5,Ni PLT,SUM24L,#4-40	2	S.N.A
..2		BN61-02426B	BRACKET-SHIELD;LS20HABW,SPT,E,T 0.3	1	S.N.A
..2	M0006	BN96-03874B	ASSY SHIELD P-COVER;DVORAK19,SECC,0.8	1	SA
...3	T0069	AA60-00171T	SPACER-FELT;56L7,FELT,50,T0.5,8	1	S.N.A
...3		BN61-02429D	STUD-PEM;PNB,M2.8,D7,L20,ZPC(SIL),SUM24L	1	S.N.A
...3	M0140	BN63-01474A	FELT-STAND;VENICE 20°,FELT,T1.0,10,15	2	S.N.A
...3		BN63-01774A	SHIELD-INSULATOR;B117/19BS,PET,TO.35	1	S.N.A
...3	M0107	BN63-02679A	SHIELD-COVER;DVORAK,SECC,0.8	1	S.N.A

6 Electrical Parts List

Level	Loc. No.	Code No.	Description & Specification	Q'ty	SA/SNA
0.1	M0112	BN91-01137A	ASSY SHIELD;DVORAK 19,4:3	1	S.N.A
..2	T0081	6002-001294	SCREW-TAPPING;BH,+,-,M4,L16,ZPC(BLK)	3	S.A
..2	M2893	BN39-00682B	LEAD CONNECTOR;DVORAK,UL1571#30,UL/CSA,3	1	S.A
..2	M0174	BN44-00137B	IP BOARD;PWI1704SM(A),DVORAK,3.8mA,7.5mA	1	S.N.A
..2	T0514	BN61-02578A	BRACKET-SUPPORT;DVORAK,SECC,1,2	1	S.N.A
..2		BN63-01781A	SHIELD-LAMP;BI19BS,SPTE,T0.3	1	S.N.A
..2	M0524	BP39-00028A	CONNECT WIRE;BI17,19BS,UL1007#26,9P,80mm	1	S.A
..2	M0081	6003-000282	SCREW-TAPTITE;BH,+,-,B,M3,L8,ZPC(BLK),SW	4	S.N.A
..2	M0081	6003-000282	SCREW-TAPTITE;BH,+,-,B,M3,L8,ZPC(BLK),SW	4	S.N.A
0.1	M0003	BN92-01944A	ASSY BOX;LS19DOASS/EDC,941MP	1	S.N.A
..2	M0120	BH75-10529A	UNIT-HANDLE PACKING;LXA410TLMU,PE,-,WHIT	1	S.A
...3	M0103	BN66-00007A	LEVER-TOP;ALL MODEL,LDPE,WHITE	1	S.N.A
...3	M0102	BN66-00008A	LEVER-BOTTOM;ALL MODEL,LDPE,WHITE	1	S.N.A
..2	BOX	BN69-01426A	BOX-MONITOR;LS19DOA,SY-01,A,A1,W498,D476	1.02	S.N.A
0.1	M0045	BN92-01945B	ASSY ACCESSORY;LS19DOASS/EDC	1	S.N.A
..2	T0074	BN59-00403B	REMOCON;MH17ES,TM75,160*55*22,S3C1860XP0	1	S.A
..2	M0013	BN96-02332D	ASSY STAND P-BASE;HA19AS/BS,HIPS,GR70 &	1	S.A
...3	M0081	6003-000282	SCREW-TAPTITE;BH,+,-,B,M3,L8,ZPC(BLK),SW	4	S.N.A
...3	T0524	6902-000389	BAG PE;T0.015/T0.5/T0.015,W350,L300,TRP,	1	S.N.A
...3		BN61-01235A	SUPPORT-BRKT BASE;MJ19AS/BS,SECC,T1.6	1	S.N.A
...3	CIS4	BN61-01717A	HOLDER-STAND;BIZET,NI PLT,CH,+M4,L11(5)	1	S.N.A
...3	T0004	BN63-01991B	COVER-STAND BASE;HA19AS/BS,HIPS,T2.5,BK2	1	S.N.A
...3		BN63-01992D	COVER-STAND TOP;HA19AS/BS,HIPS,T2.5,GR70	1	S.N.A
...3		BN68-00786F	MANUAL FLYER-QSG;Bizet Stand Manual,Sync	1	S.N.A
...3	T0132	BN73-00077A	RUBBER FOOT;MATISSE,BUMPON, ³ 13.5,T2.0,6	4	S.N.A
..2	M0045	BN96-03963A	ASSY ACCESSORY;LS19DOASS/EDC	1	S.N.A
...3	T0268	3903-000042	CBF-POWER CORD;DT,EU,FP3/YES,IEC320 C13/	1	S.A
...3	T0524	6902-000110	BAG PE;T0.05,W250,L400,TRP,28,2,-	1	S.N.A
...3	ACCESSORY	BH68-70448A	CARD-01;TFT LCD,SRC,RUSSIA,S/W,120,W210*	1	S.N.A
...3	T0128	BN39-00061B	CBF SIGNAL-STEREO;MH15NS,1P,UL2851#26,20	1	S.A
...3	M0114	BN39-00244A	CBF SIGNAL;BU15AO(T541A),15P/15P,20276-N	1	S.A
...3	T0059	BN68-00907A	MANUAL FLYER-CARD;COMM,SAMSUNG,18 LANG,E	1	S.N.A
...3	M0215	BN96-03964A	ASSY MANUAL P-IB+QSG;741MP,941MP,Kor,Kor	1	S.N.A
....4	I/B	BN59-00566A	S/W DRIVER-00,IB;741MP,941MP,W/W,PAL,Syn	1	S.N.A
....4	QSG	BN68-01071A	MANUAL FLYER-QSG;741MP,941MP,SyncMaster,	1	S.N.A
...3	T0238	BH68-00633A	MANUAL FLYER-WARRANTY CARD;comm,Samsung,	1	S.N.A
0.1	M0019	BN92-01946B	ASSY LABEL;LS17DOASS/EDC	1	S.N.A
0.1	M0113	BN92-01947B	ASSY P/MATERIAL;LS19DOASS/EDC,YES	1	S.N.A
..2	T0376	6902-000061	BAG AIR;T0.2,W500,L1000,TRP,-,-,-	0.009	S.N.A
..2	T0524	6902-000241	BAG PE;T0.5/T0.012,W600,L600,WHT,28,4,-	1	S.N.A
..2	T0376	6902-000379	BAG AIR;T0.2,W1000,L1800,TRP,-,-,-	0.002	S.N.A
..2	T0081	6902-000604	BAG WRAPPING;T0.02,W500,L10000,TRP,-,-,-	1.21	S.N.A
..2	M0081	6902-000609	BAG ROLL;T0.05,W2400,L1000,TRP,-,-,-	0.02	S.N.A

7 Block Diagram

7-1 Block Diagram

Dvorak BLOCK DIAGRAM (For European Model)

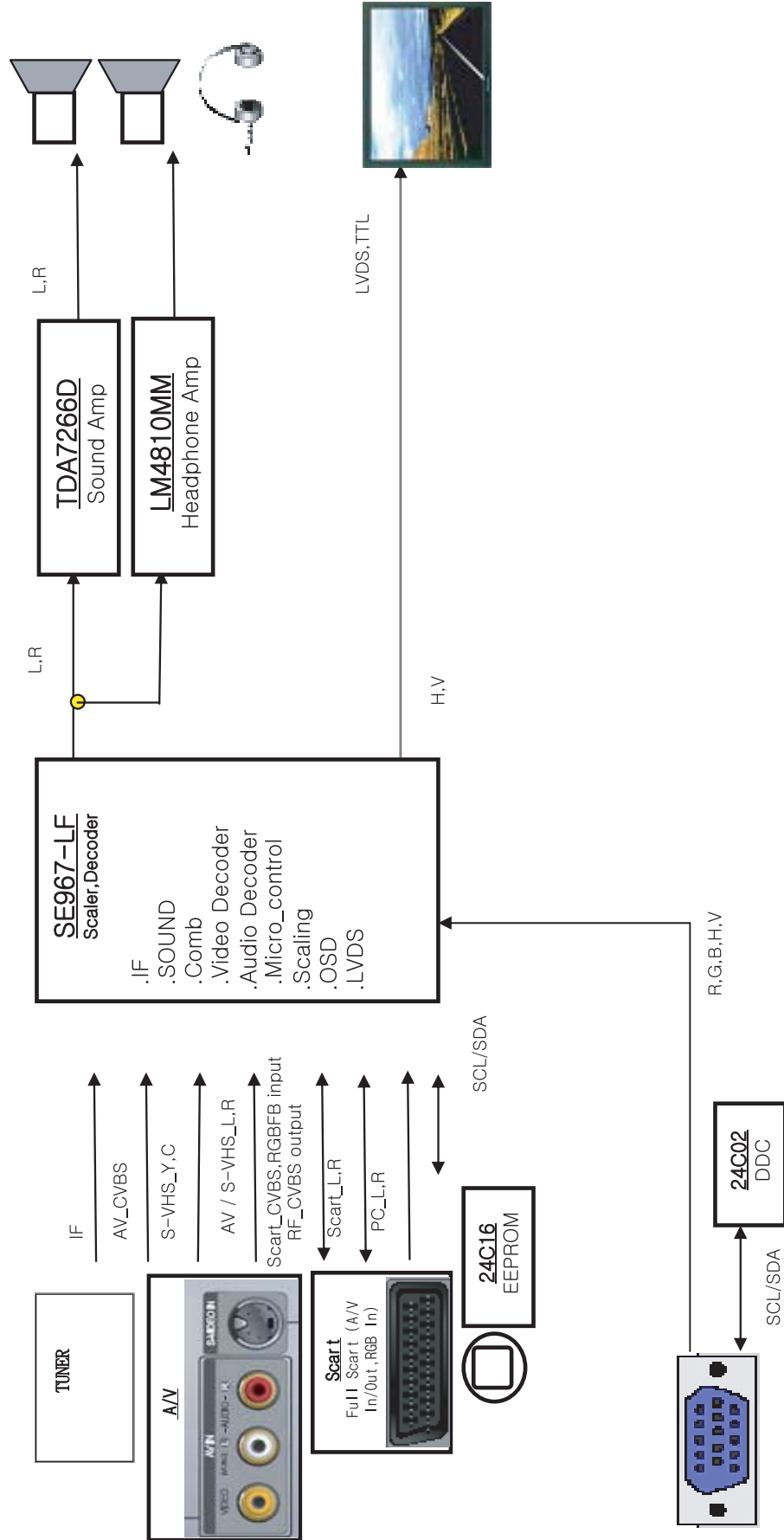

For Detailed Information, Please Refer to the Datasheet

7-2 Power Flow

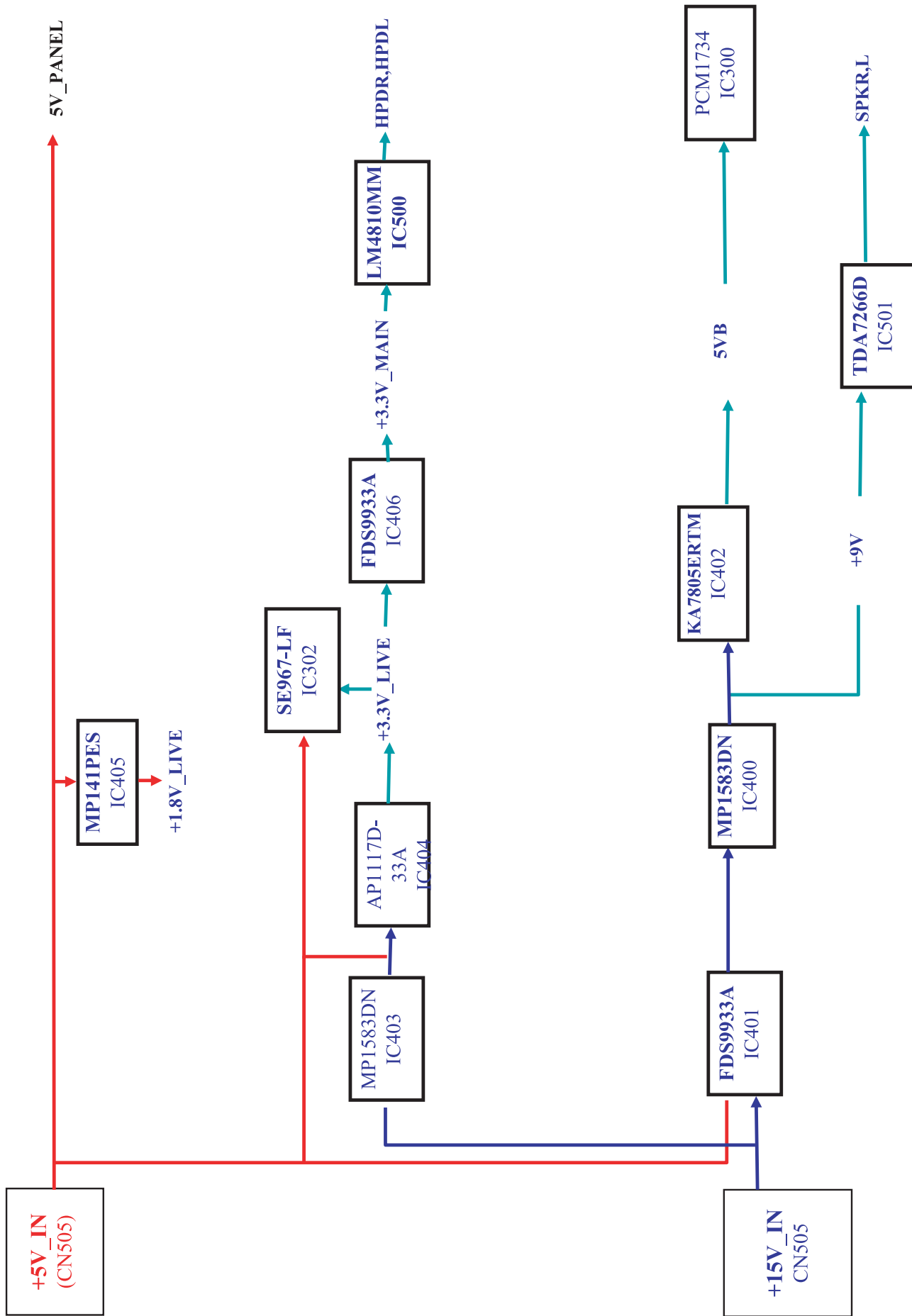

8 Wiring Diagram

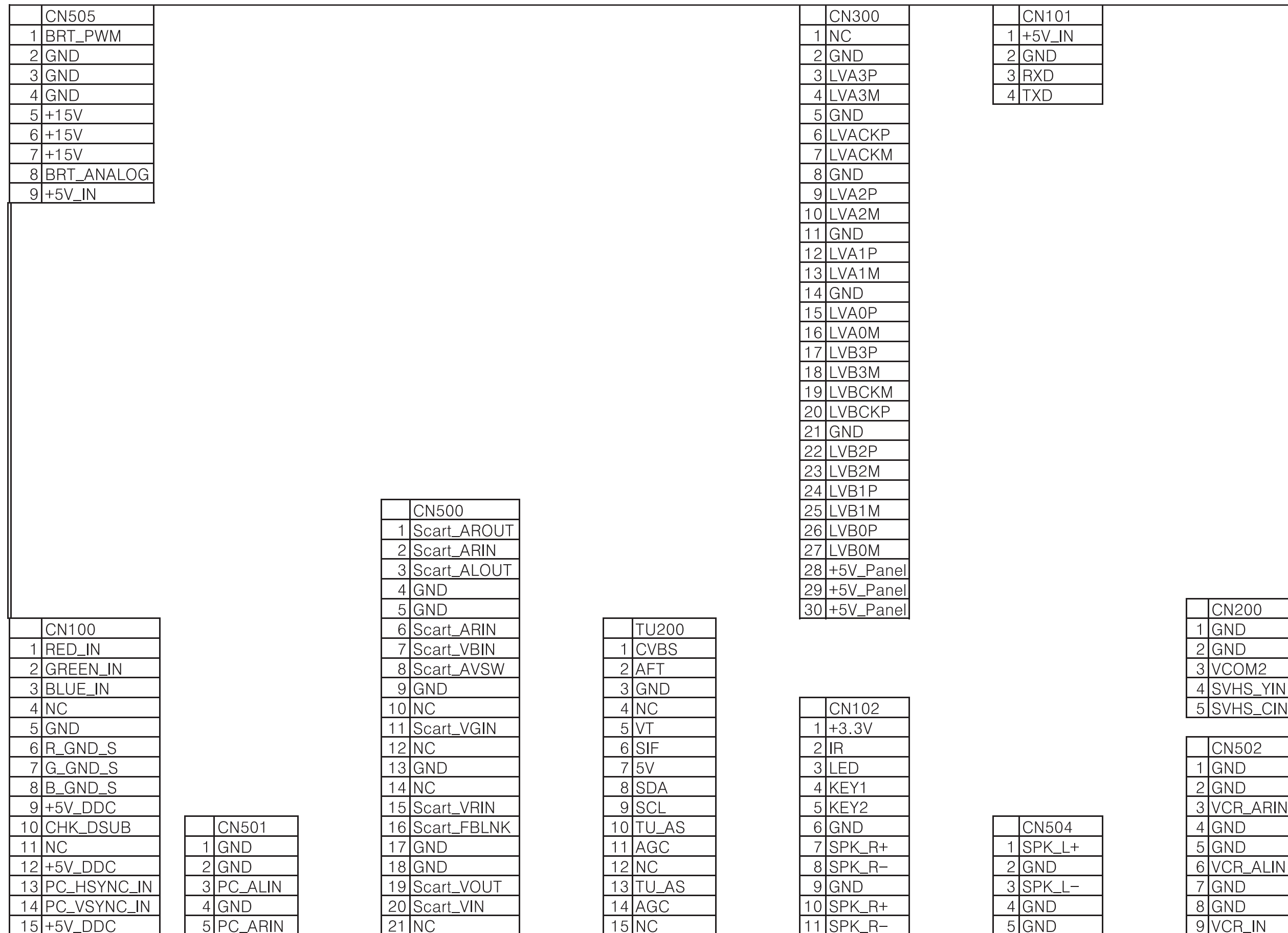

8 Wiring Diagram

Memo

9 Schematic Diagrams

- This Document can not be used without Samsung's authorization.

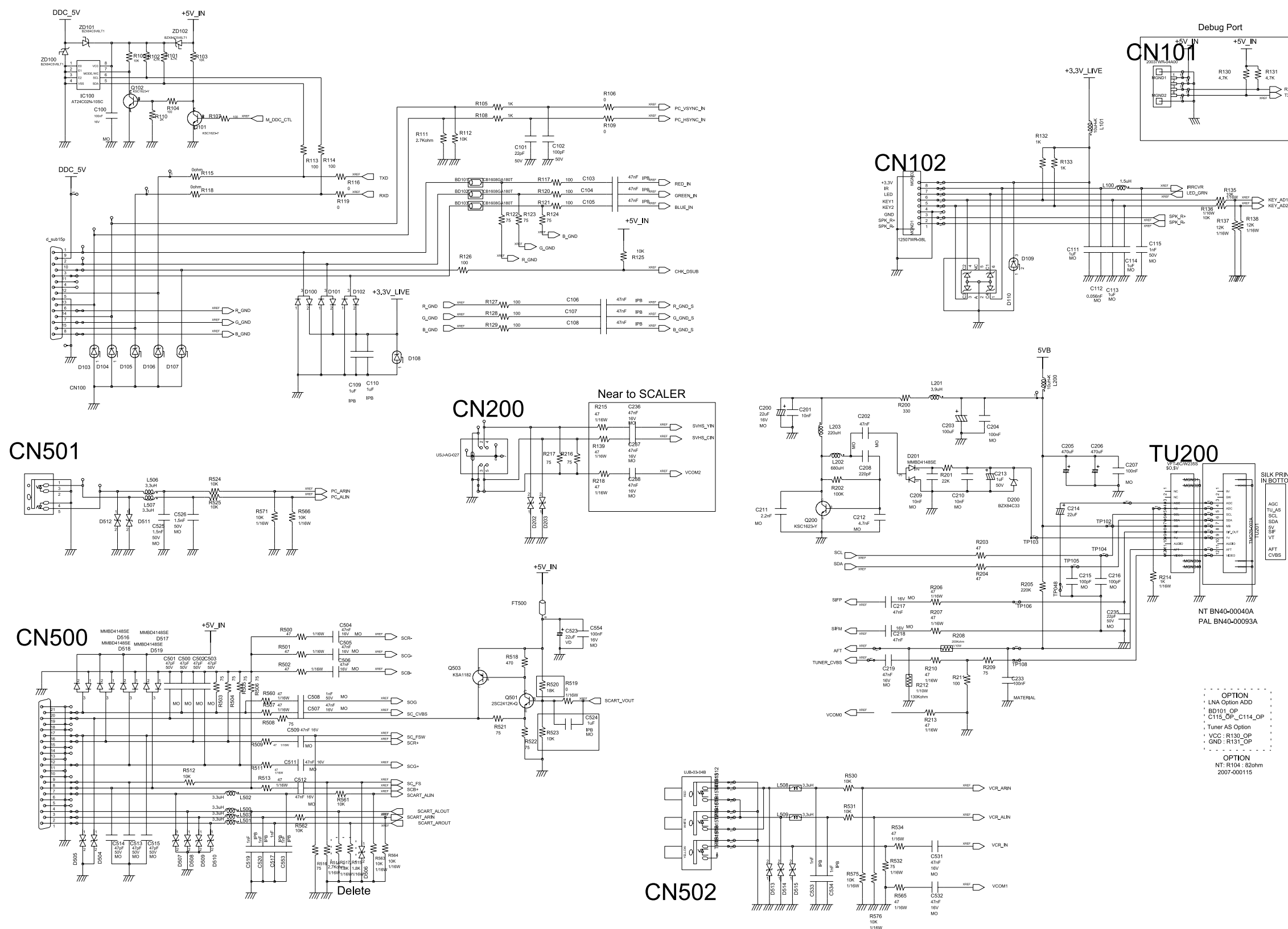

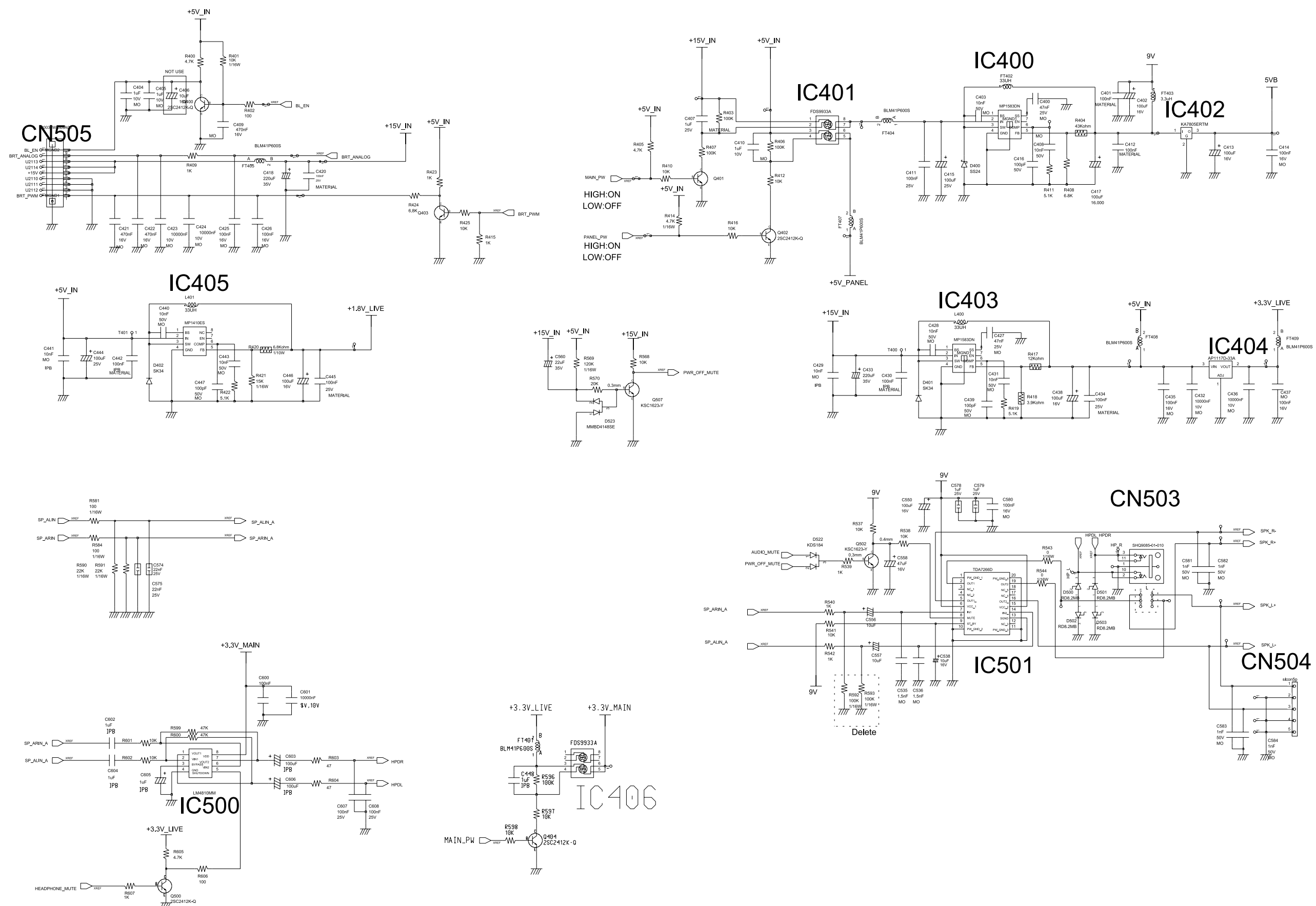

Memo

10 Operating Instructions and Installation

10-1 Front

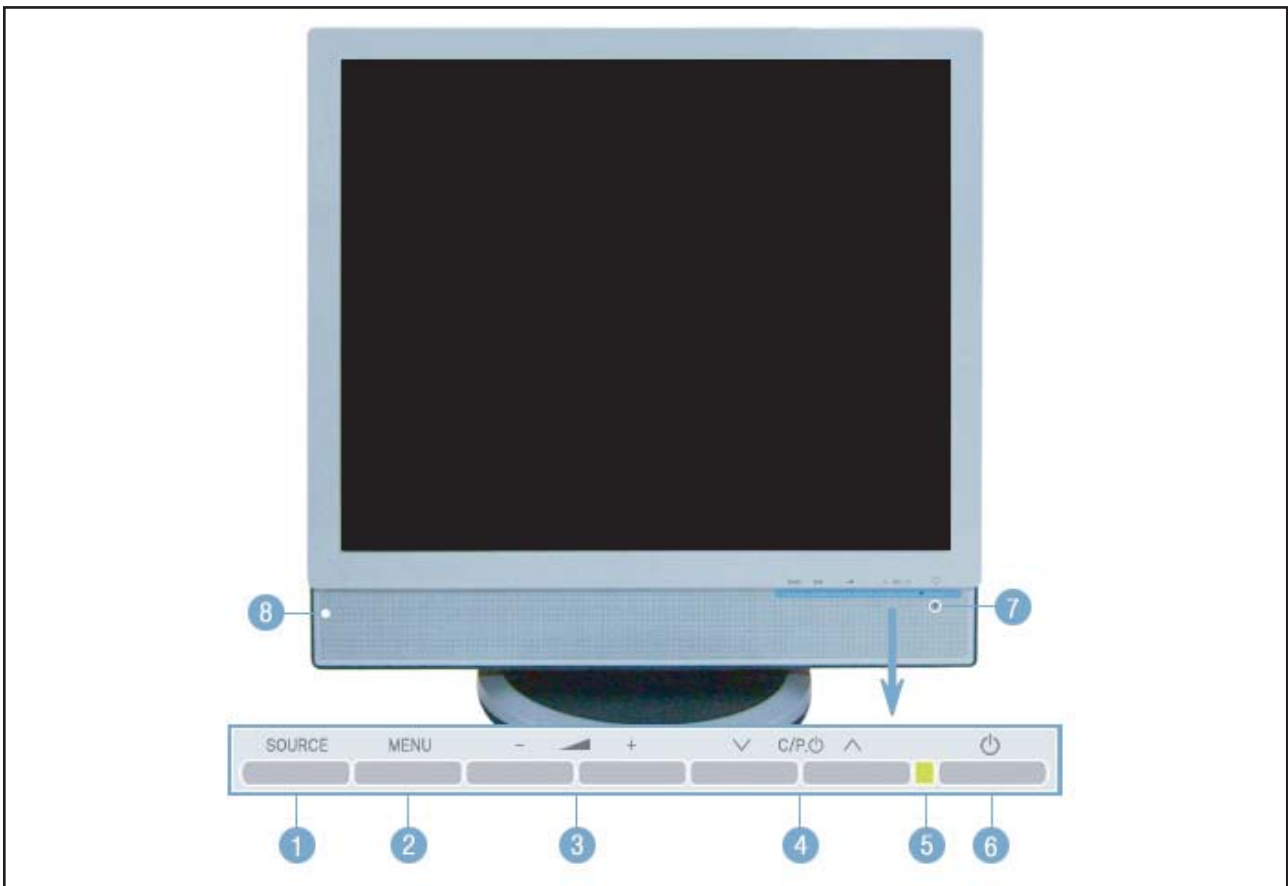

1. SOURCE

Switches from PC Mode to Video mode. Changing the source is allowed only in external devices that are connected to the monitor at the time.

To switch Screen modes:

[PC] > [TV] > [Ext.] > [AV] > [S-Video]

2. MENU

Use this button to open the on-screen menu and step back in the menu.

3. — ◀ ▶ +

Moves from one menu item to another horizontally or adjusts selected menu values.

Adjusts the audio volume.

4. ∨ C/P. ⏻ ⏶

Moves from one menu item to another vertically or adjusts selected menu values.

In TV mode, selects TV channels.

5. Power indicator

Power Indicator shows Power Saver mode by green blinking.

6. [⏻] Power button

Use this button to turn the monitor on and off.

7. Remote Control Sensor

Aim the remote control towards this spot on the monitor.

8. Speaker

You can hear sound by connecting the soundcard of your PC to the monitor.

10-2 Rear



1. POWER

Power cord, plugs into monitor and wall receptacle. This product may be used with 100 ~ 240VAC (+/- 10%).



2. PC IN

Computer Connection Terminal (15 Pin D-SUB)





3. PC AUDIO IN

Audio Connection Terminal

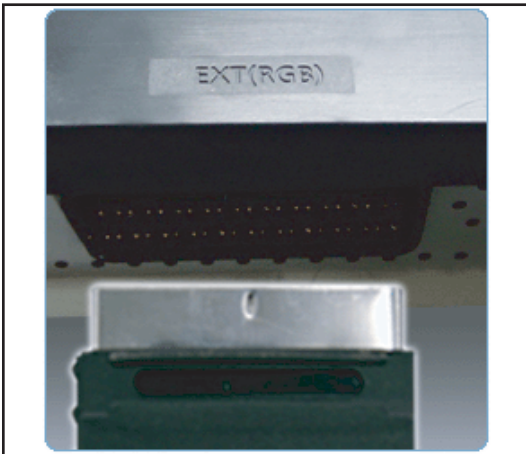

4. EXT(RGB)

External device terminal
EXT(RGB) is mainly used in Europe.

As for EXT(RGB) port of the monitor, it makes TV or Video signal input and output.



4. ANT IN

TV Connection Terminal



5. AV Connection Terminal

1. Headphone Connection Terminal (Output)
2. S-Video Connection Terminal (Input)
3. Video Connection Terminal (Input)
4. Right(R) / Left(L) audio Connection Terminal (Input)



6. Kensington Lock

The Kensington lock is a device used to physically fix the system when using it in a public place.
(The locking device has to be purchased separately.)

For using a locking device, contact where you purchase it.

10-3 Remote Control

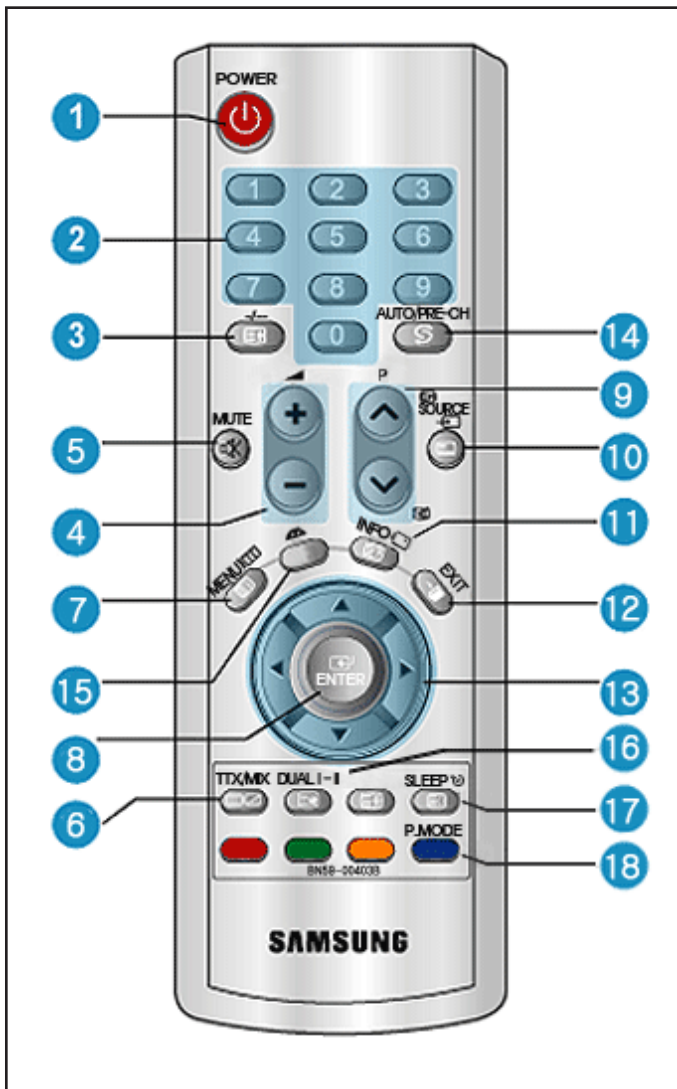

- 1. POWER
- 2. number buttons
- 3. +/-
- 4. - \blacktriangleleft + (Volume)
- 5. MUTE
- 6. TTX/MIX
- 7. MENU
- 8. ENTER
- 9. ^ P v
- 10. SOURCE
- 11. INFO
- 12. EXIT
- 13. Up-Down Left-Right Buttons
- 14. AUTO / PRE-CH
- 15. \blacktriangle (MagicBright)
- 20. S.MODE
- 16. DUAL I - II
- 17. SLEEP
- 18. P.MODE

1. POWER

Use this button to turn the monitor on and off.

2. Number button

Selects TV channels in the TV mode.
You may use this button in PIP mode as well.

3. -/-- (One/Two-Digit CHANNEL selection)

Use to select a CHANNEL numbered ten or over.
Press this button, and the "--" symbol is displayed.
Enter the two-digit CHANNEL number.

4. – ◀ + (Volume)

Adjusts the audio volume.

5. MUTE

Pauses (mutes) the audio output temporarily.
Displays on the lower left corner of the screen.
The audio resumes if mute or – ◀ + is pressed in the Mute mode.

6. TTX/MIX

TV channels provide written information services via teletext.
This function is available only in Europe.

7. MENU

Use this button to open the on-screen menu and exit from the menu screen or close screen adjustment menu.

8. ENTER

Activates a highlighted menu item.

9. ^ P v

In TV mode, selects TV channels.

10. SOURCE

Switches from PC Mode to Video mode.
Changing the source is allowed only in external devices that are connected to the monitor at the time.

11. INFO

Current picture information is displayed on the upper left corner of the screen.

12. EXIT

Exits from the menu screen.

13. Up-Down Left-Right buttons

Moves from one menu item to another horizontally, vertically or adjusts selected menu values.

14. AUTO / PRE-CH

PC mode

Adjusts the screen display automatically.

TV mode

This button is used to return to the previous channel immediately

15. (MagicBright)

PC Mode:

MagicBright is a new feature providing the optimum viewing environment depending on the contents of the image you are watching.
Then press the button again to circle through available preconfigured modes.
(Entertain ;æ Internet ;æ Text ;æ Custom)

16. DUAL I - II

STEREO / MONO can be operated depending on broadcasting type by using DUAL button on the remote control while watching TV.

17. SLEEP

Turns the monitor off after a pre-determined period of time.

18. P.MODE

When you press this button, current mode is displays on the lower center of the screen.

TV / Ext. / AV / S-Video Mode:

The Monitor has four automatic picture settings that are preset at the factory.
Then press the button again to circle through available preconfigured modes.
(Dynamic ;æ Standard ;æ Movie ;æ Custom)

11 Disassembly and Reassembly



This section of the service manual describes the disassembly and reassembly procedures for the LS17DOA, LS19DOA TFT-LCD monitors.



⚠ WARNING: This monitor contains electrostatically sensitive devices. Use caution when handling these components.

11-1 Disassembly

⚠ Cautions:

1. Disconnect the monitor from the power source before disassembly.
2. Follow these directions carefully; never use metal instruments to pry apart the cabinet.

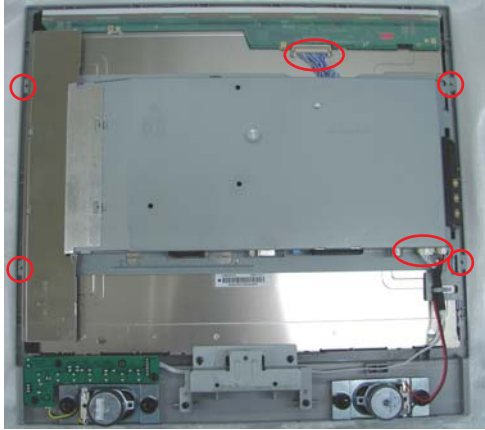
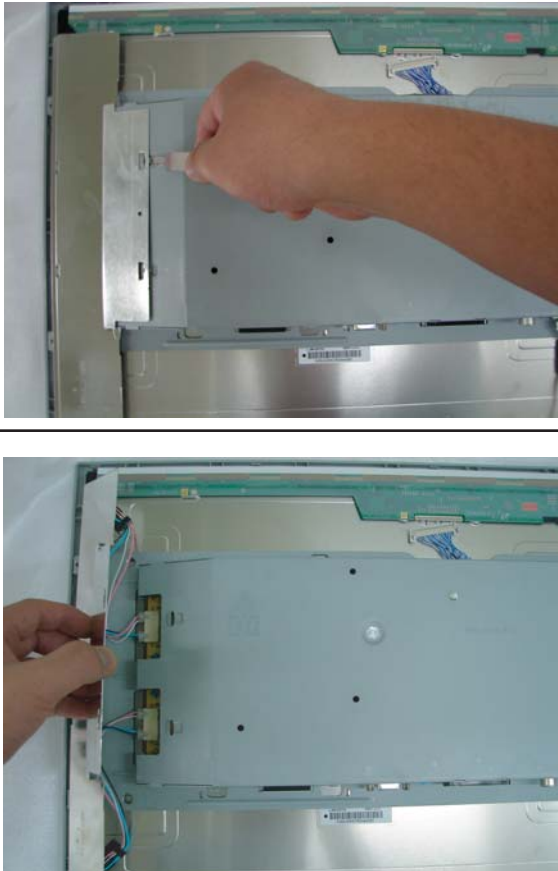
Description	Picture Description
<p>1. Place monitor face down on cushioned table. Remove 3 screws from the stand.</p>	
<p>2. Lift up the rear-cover.</p>	 

Description	Picture Description
<p>3. Remove 4 screws from the shield-cover and Disconnect cables.</p>	
<p>4. Use the jig to remove the shield lamp.</p>	
<p>5. Disconnect cables.</p>	

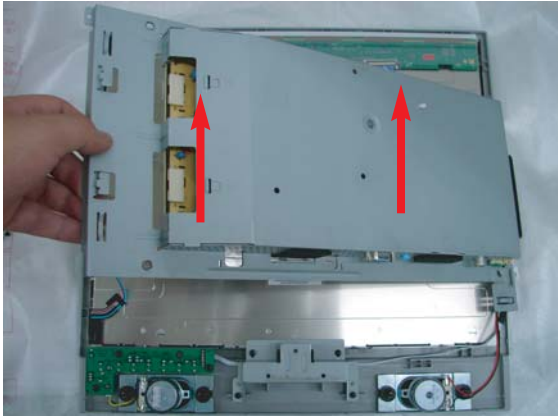
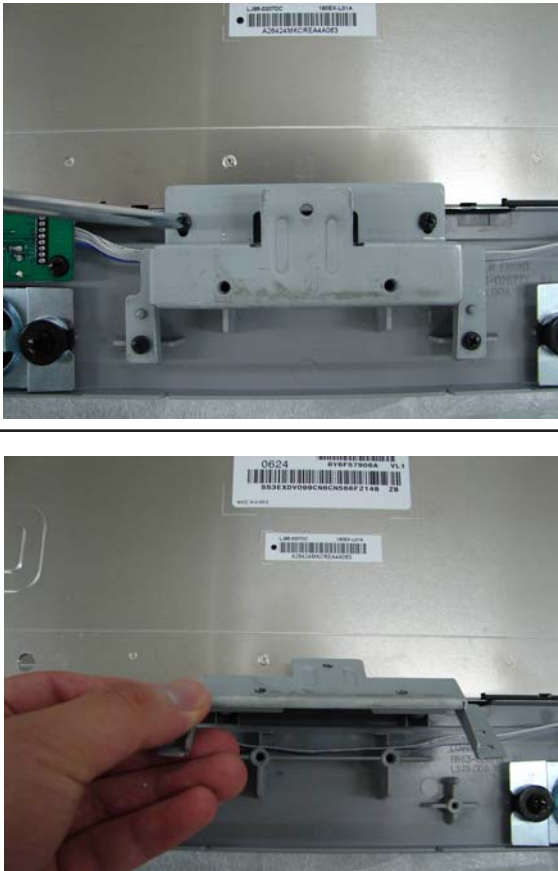
Description	Picture Description
<p>6. Remove the board.</p>	
<p>7. Remove 4 screws.</p>	

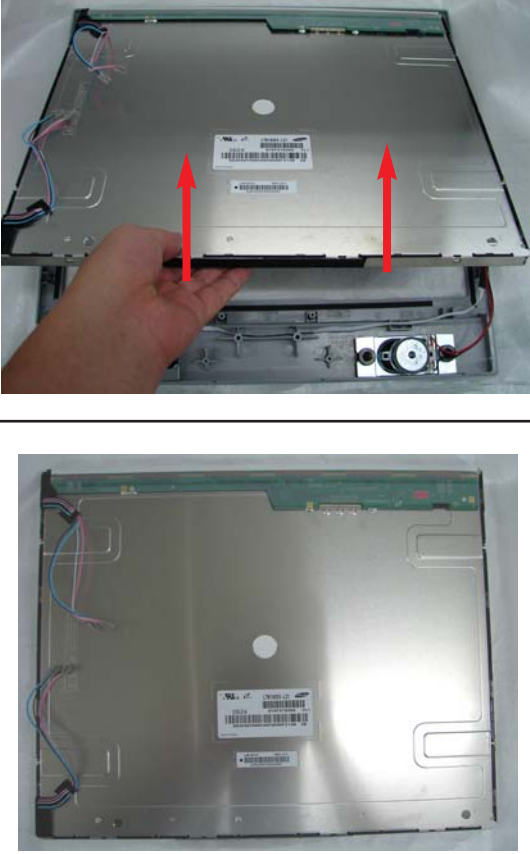
Description	Picture Description
8. Lift up the LCD Panel	

11-2 Reassembly

-Reassembly procedures are in the reverse order of disassembly procedures.

12 PCB Diagram

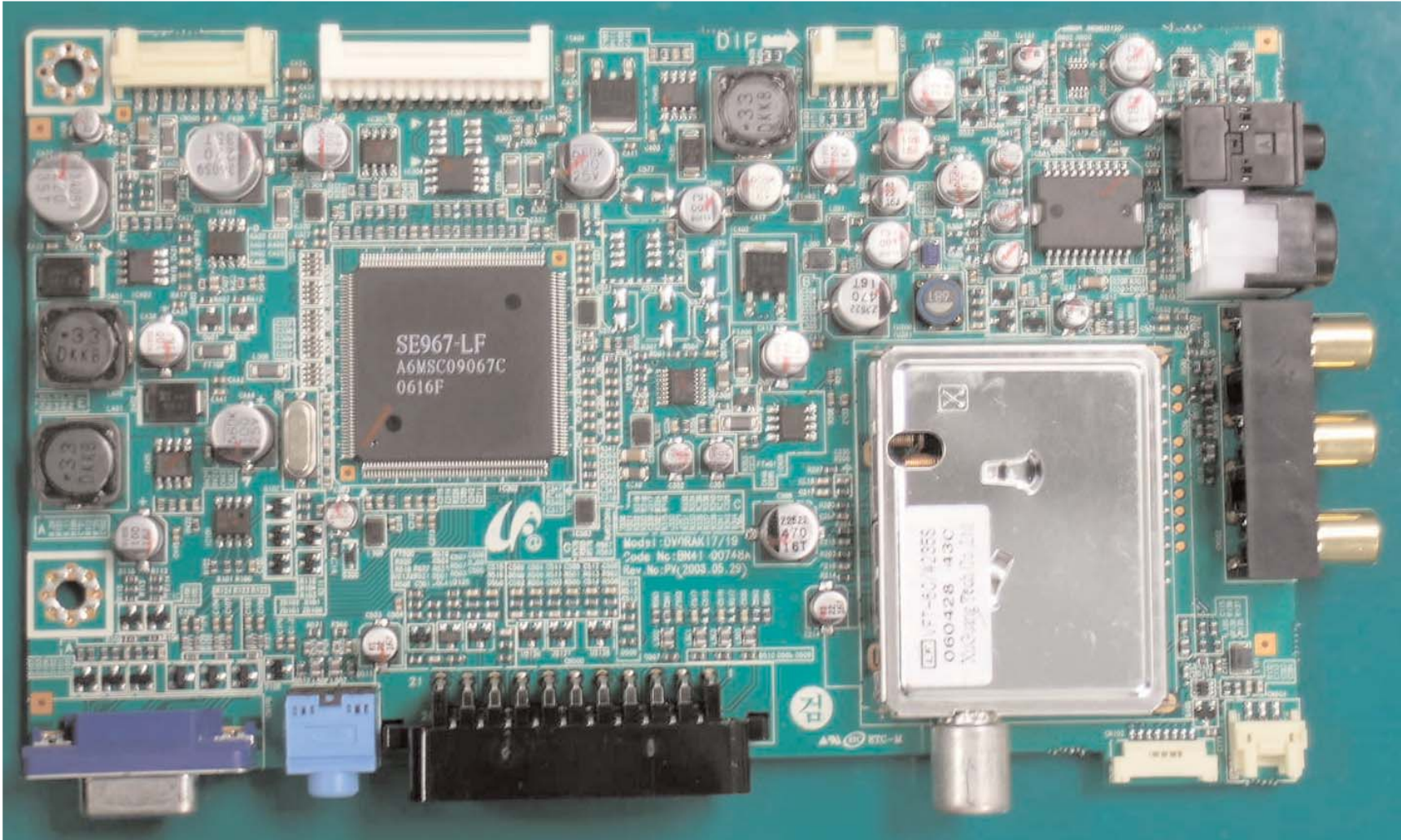

Memo

13-1-1 VCT49XYI (IC700)

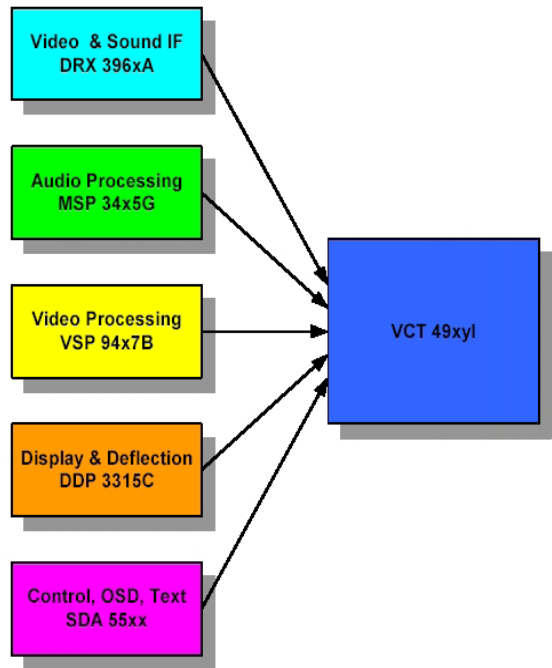
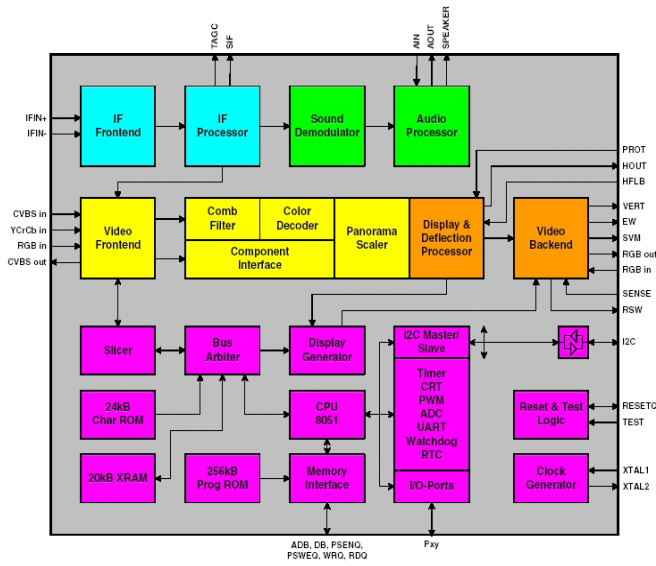

13-1-2 VSP Block

: CVBS, S-Video, RF(IF), SCART (RGB) Convert 656 format to video input and transfer to MST51510

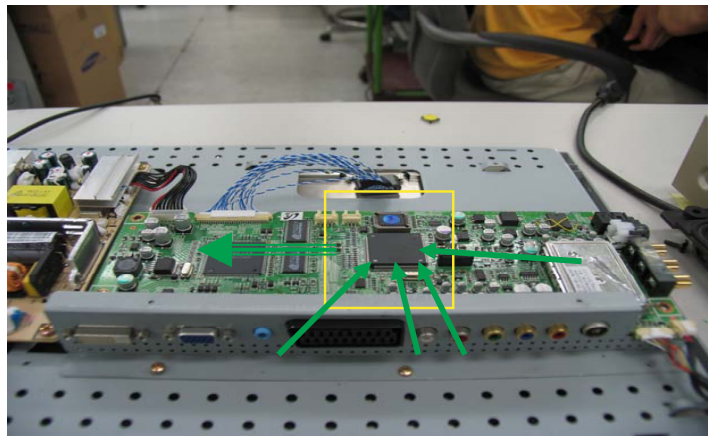

External Video Signal Input

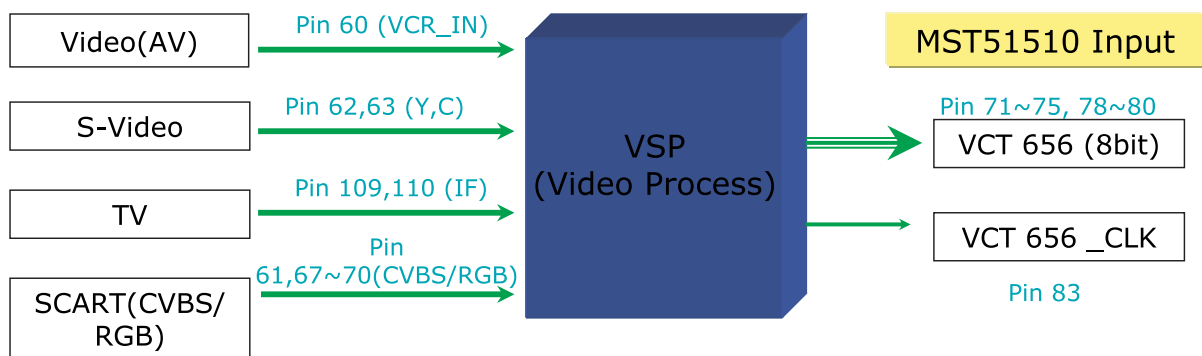

13-1-3 MSP Block

: PC, Sound L/R, SCART,
Receive audio input and send
out to AMP.

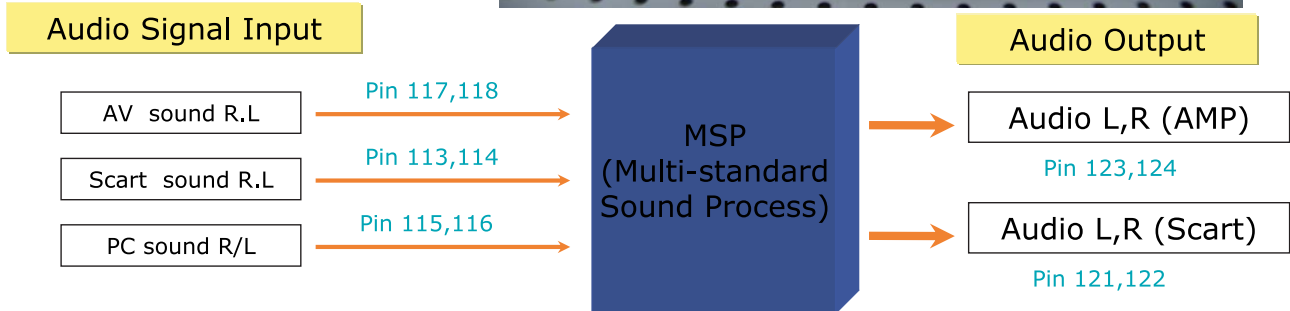
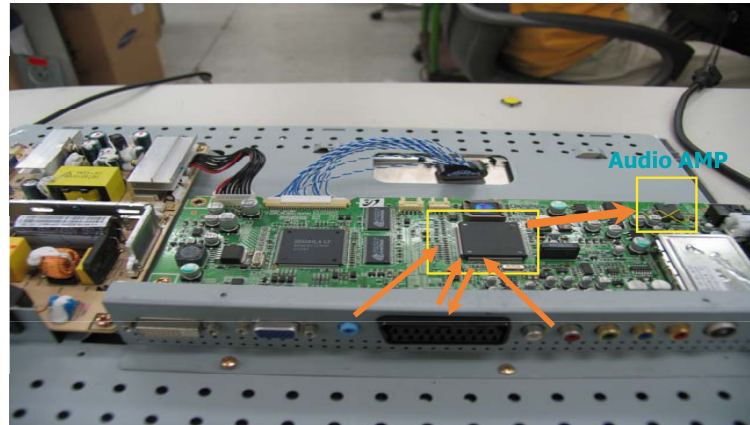

13-1-4 SE6181(IC301)

- Scaler(MFM)
- Support Digital Video Input
- Internal LVDS IC
- Support PIP
- OSD controller engine

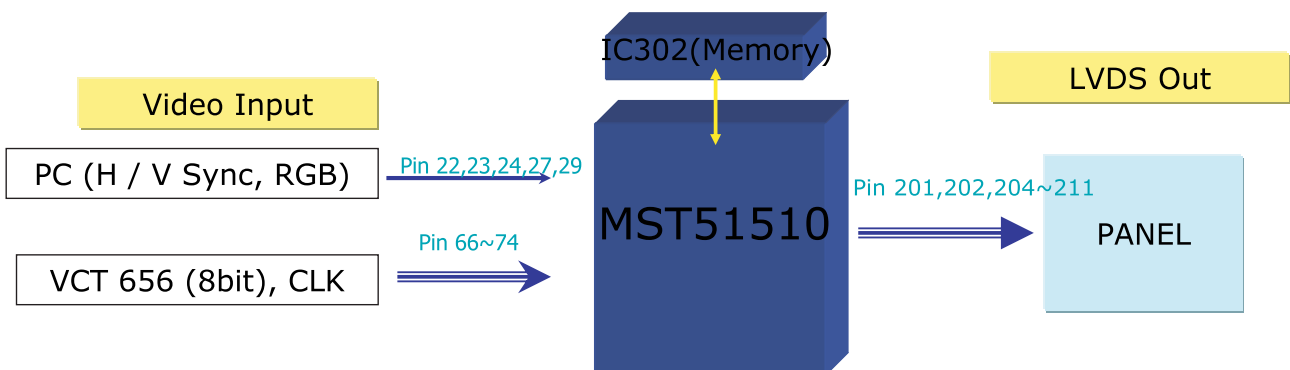
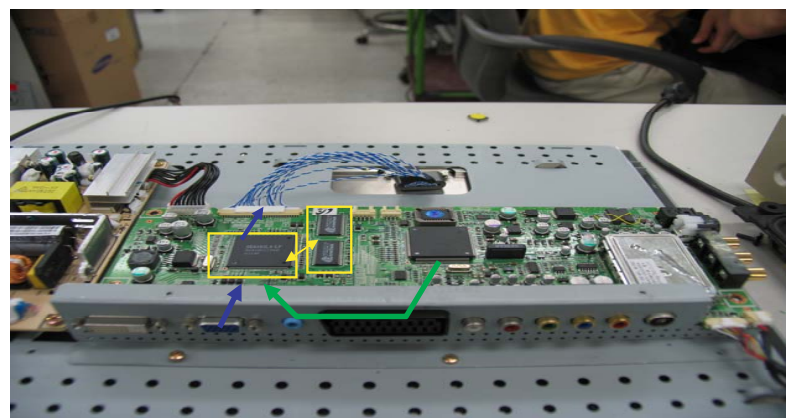

13-1-5 Connect a Function Board to a Main Board

1	SPK_R-
2	SPK_R+
3	NC
4	NC
5	GND
6	KEY_AD2
7	KEY_AD1
8	LEDGRN
9	IRRCVR
10	+3.3V_LIVE

Connect to
CN111(Function),CN402(Speake
) on Main Board

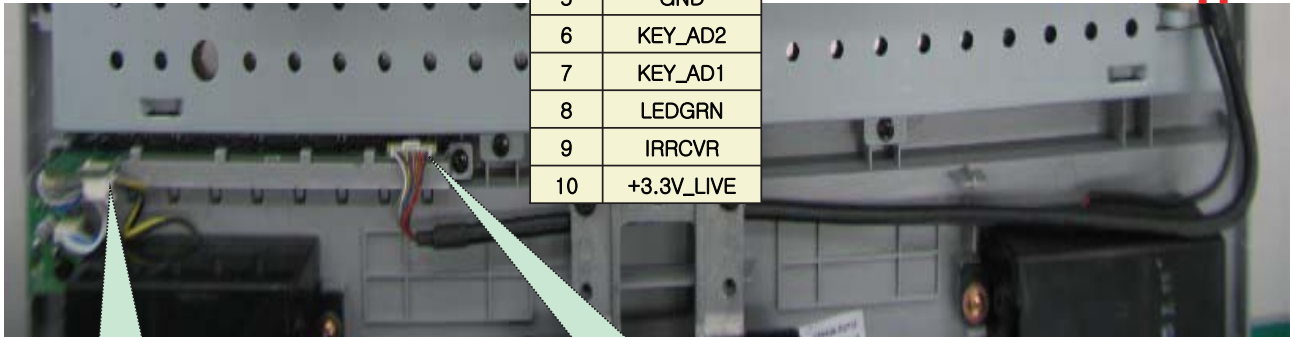

Speaker
(R)

Speaker (L)

Speaker Connector
Connect with right speaker

Function Connector
(Connect with Main board)

14 Reference Information

14-1 Technical Terms

- **TFT-LCD**

(Thin film Transistor Liquid Crystal Display)

ADC(Analog to Digital Converter)

This is a circuit that converts from analog signal to digital signals.

- **PLL(Phase Locked Loop)**

During progressing ADC, Device makes clock synchronizing HSYNC with Video clock

- **Inverter**

Device that supply Power to LCD panel lamp. this device generate about 1,500~2,000V.

- **AC Adapter**

Device that converts AC(90V~240V) to DC(+12V or 14V)

- **SMPS(Switching Mode Power Supply)**

Switching Mode Power supply. This design technology is used to step up/down the input power by switching on/off

- **FRC(Frame Rate Controller)**

Technology that change image frame quantity displayed on screen for one second.

Actually TFT-LCD panel require 60 pcs of frame for one second.

so,this technology is needed to convert input image to 60 pcs regardless input frame quantity.

- **Image Scaler**

Technology that convert various input resolution to other resolution.(ex. 640* 480 to 1024*768)

- **Auto Configuration(Auto adjustment)**

This is an algorithm to adjust monitor to optimum condition by pushing one key.

- **OSD(On Screen Display)**

On screen display. customer can control the screen easily with this.

- **Image Lock**

This means "Fineness adjustment " in LCD Monitor, the features are "Fine" and "Coarse"

- **FINE**

"Fine" adjustment is used to adjust visibility by control phase difference.

- **COARSE**

This is a adjustment by tuning with Video colck and PLL clock.

- **DVI (Digital Visual Interface)**

This provides a high speed digital connection for visual data types that is display technology independent. this interface is primarily focused at providing a connection between a computer and its display device.

- **L.V.D.S.(Low Voltage Differential Signaling)**

a kind of transmission method for Digital.It can be used from Main PBA to Panel.

- **T.M.D.S**

(Transition minimized Differential Signaling)

a kind of transmission method for Digital.

It can be used from Video card to Main PBA.

- **DDC(Display data channel)**

It is a communication method between Host Computer and related equipment.

It can make it Plug and Play between PC and Monitor.

- **EDID**

Extended Display Identification Data PC can recognize the monitor information as Product data, Product name,Display mode,Serial number and Signal source,etc through DDC Line communicating with PC and Monitor.

- Dot Pitch

The image on a monitor is composed of red, green and blue dots. The closer the dots, the higher the resolution. The distance between two dots of the same color is called the 'Dot Pitch'. Unit: mm

- Vertical Frequency

The screen must be redrawn several times per second in order to create and display an image for the user. The frequency of this repetition per second is called Vertical Frequency or Refresh Rate. Unit: Hz

Example: If the same light repeats itself 60 times per second, this is regarded as 60 Hz.

- Horizontal Frequency

The time to scan one line connecting the right edge to the left edge of the screen horizontally is called Horizontal Cycle. The inverse number of the Horizontal Cycle is called Horizontal Frequency. Unit: kHz

- Interlace and Non-Interlace Methods

Showing the horizontal lines of the screen from the top to the bottom in order is called the Non-Interlace method while showing odd lines and then even lines in turn is called the Interlace method. The Non-Interlace method is used for the majority of monitors to ensure a clear image. The Interlace method is the same as that used in TVs.

- Plug & Play

This is a function that provides the best quality screen for the user by allowing the computer and the monitor to exchange information automatically. This monitor follows the international standard VESA DDC for the Plug & Play function.

- Resolution

The number of horizontal and vertical dots used to compose the screen image is called 'resolution'. This number shows the accuracy of the display. High resolution is good for performing multiple tasks as more image information can be shown on the screen.

Example: If the resolution is 1280 x 1024, this means the screen is composed of 1280 horizontal dots (horizontal resolution) and 1024 vertical lines (vertical resolution).

- DVD

A type of digital disk technology that takes up only the benefits of CD and LD, to implement a high resolution/quality, which enables the user to enjoy clearer images.

- DTV

Broadcasting (Digital TV Broadcasting)
An enhanced broadcasting technology to process digital video signals using a set-top box, which implements a high resolution and clearer digital images on the screen.

- A2

This system uses two carriers to transmit voice data. Countries such as South Korea and Germany use this system.

- BTSC

Broadcast Television System Committee
The stereo broadcasting system that is used in most of the countries that have adopted the NTSC system, including the United States, Canada, Chile, Venezuela and Taiwan. It also refers to the organization that has been organized to promote its development and management.

- EIAJ

Electronic Industries Association of Japan.

- RF Cable

A round signal cable generally used for TV antennas.

- Satellite Broadcasting

Broadcasting service provided via satellite. Enables high picture quality and clear sound throughout the country regardless of the location of the viewer.

- Sound Balance

Balances the levels of the sound coming from each speaker in televisions with two speakers.

- Cable TV

Whereas the terrestrial broadcasting is delivered via frequency signals through the air, cable broadcasting is transmitted via a cable network. In order to view cable TV, one must purchase a cable receiver and hook it up to the cable network.

- CATV

"CATV" refers to the broadcasting service offered at hotels, schools and other buildings through their own broadcasting system, apart from VHF or UHF broadcasting by terrestrial broadcasters. The CATV programs may include movies, entertainment and educational programs. (Different from cable TV.)
CATV can be viewed only within the area in which the CATV service is offered.

- S-Video

Short for "Super Video." S-Video allows up to 800 lines of horizontal resolution, enabling high-quality video.

- VHF/UHF

VHF indicates TV channels 2 to 13, and UHF indicates channels 14 through 69.

- Channel Fine Tuning

This feature allows the viewer to fine-tune the TV channel to obtain the best viewing conditions. The Samsung LCD TV has both automatic and manual channel fine-tuning features to enable the viewer to adjust their desired settings.

- External Device Input

External device input refers to video input from such external video device as VCR, camcorder and DVD player, separate from a TV broadcast.

- LNA (Low Noise Amplifier)

This derives from artificial satellite technology that amplifies weak signals even in poor reception areas for sharper images.

- Antenna Converter

A connection part that is used to link a wide antenna cable (feeder cable) to the TV.

- English Caption (= Caption Setting)

A kind of language selection feature that provides English subtitles (caption) or character information services from broadcasting services (ex: AFKN) or video tapes (marked CC), and which are especially useful for studying English.

14-2 Connecting the Monitor

- Connecting to a monitor

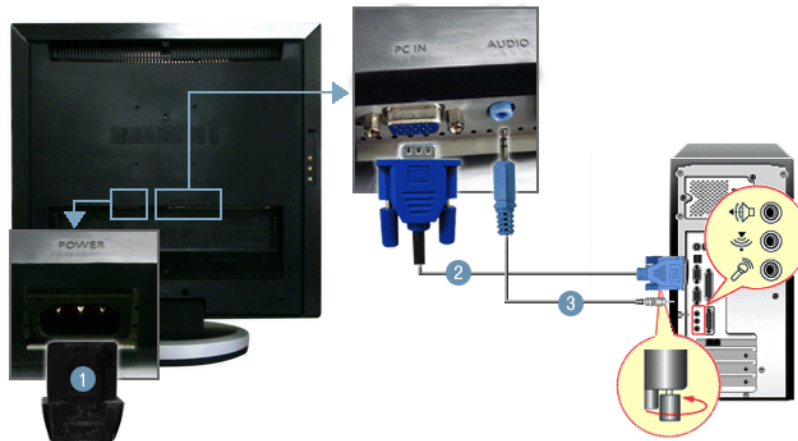

1. Connect the power cord for your monitor to the POWER on the back of the monitor. Plug the power cord for the monitor into a nearby outlet.
- 2-1. Using the D-sub (Analog) connector on the video card. Connect the signal cable to the 15-pin, RGB port on the back of your monitor.

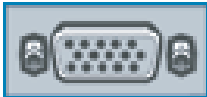

3. Connect the audio cable for your monitor to the audio port on the back of your computer.
4. Turn on both your computer and the monitor.

-Connecting to a Macintosh

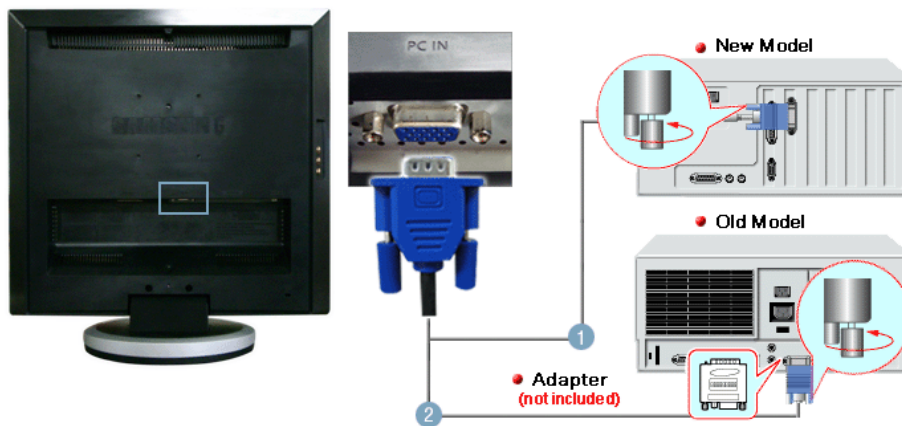

1. Using the D-sub (Analog) connector on the video card. Connect the signal cable to the D-SUB port on the Macintosh computer.



2. For older model Macintoshes, you need to adjust the resolution control DIP switch on the Macintosh adapter (optional) referring to the switch configuration table shown on its rear.
3. Turn on the monitor and Macintosh.

14-3 Connecting to Other devices

- Connecting AV Devices

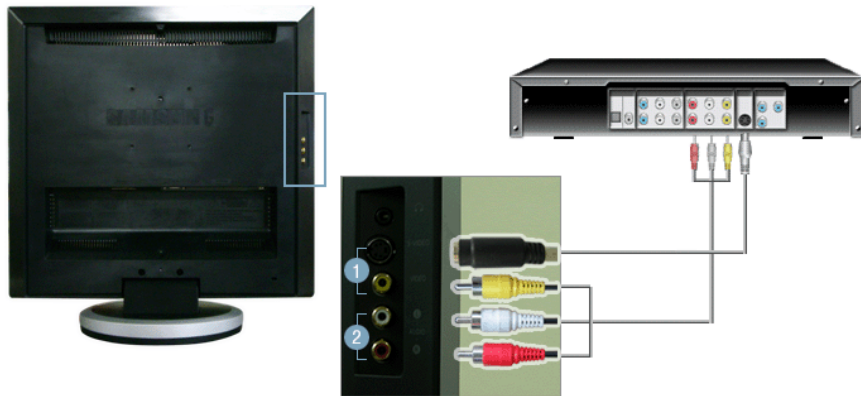

1. Input devices such as DVD, VCR or Camcorder are connected to the VIDEO or S-VIDEO terminal of the monitor using the Video or S-Video cable.

* **The S-Video cable is optional.**

2. Connect the Audio (R) and Audio (L) terminals of a DVD, VCR or Camcorders to the monitor's R and L audio input terminals using audio cables.
3. Then, start the DVD, VCR or Camcorders with a DVD disc or tape inserted.
4. Select AV or S-Video using the **SOURCE** button.

- Connecting EXT(RGB) - It only applies to AV DEVICE that supports EXT(RGB).

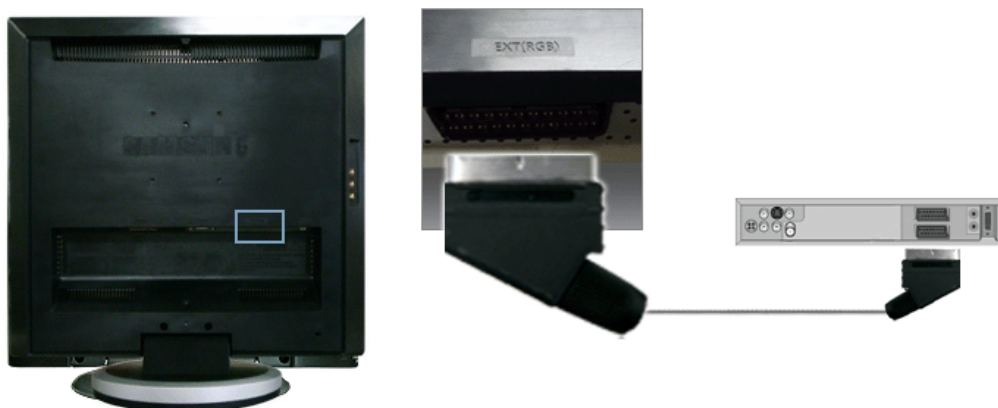

1. Connect the SCART cable to the DVD SCART connector.
2. Select Ext. by using the **SOURCE** button.

- Connecting TV

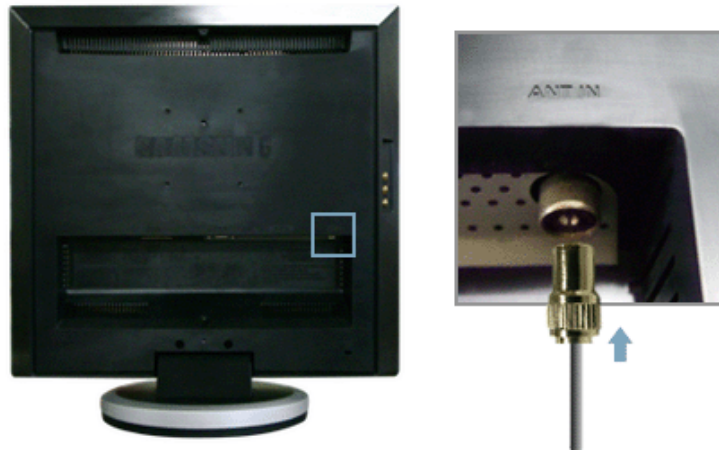

1. Connect the CATV or antenna coaxial cable to the Antenna terminal on the rear of the monitor. You need to use a coaxial antenna cable.
 - When using an interior antenna terminal:
Check the antenna terminal on the wall first and connect the antenna cable.
 - When using an outdoor antenna:
If you are using an outdoor antenna, use a professional for installation if possible.
 - To connect the RF cable to the antenna input terminal:
Keep the copper wire portion of the RF cable straight.
2. Turn on the monitor.
3. Select TV using **SOURCE** button among the external signal adjustment buttons.
4. Select a desired TV channel after channel search.

- Connecting Headphone



1. Connect your headphones to the Headphone connection terminal.

-Attaching a Base

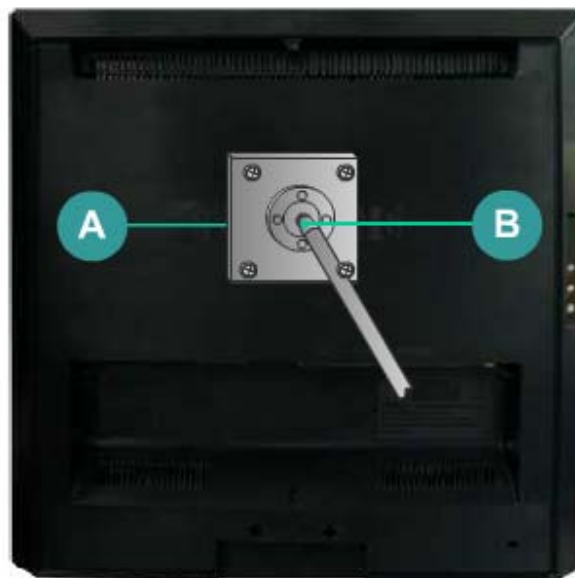

* This monitor accepts a 75 mm x 75 mm VESA-compliant mounting interface pad.

A. Monitor

B. Mounting interface pad (Sold separately)

1. Turn off your monitor and unplug its power cord.
2. Lay the LCD monitor face-down on a flat surface with a cushion beneath it to protect the screen.
3. Remove four screws and then remove the Stand from the LCD monitor.
4. Align the Mounting Interface Pad with the holes in the Rear Cover Mounting Pad and secure it with four screws that came with the arm-type base, wall mount hanger or other base.

14-4 Pin Assignments

Pin No.	Sync Type	15-Pin Signal Cable Connector	
		Separate	Composite
1		Red	Red
2		Green	Green
3		Blue	Blue
4		GND	GND
5		GND (DDC Return)	GND (DDC Return)
6		GND-Red	GND-Red
7		GND-Green	GND-Green
8		GND-Blue	GND-Blue
9		DDC +5V	DDC +5V
10		CHK D_SUB	CHK D_SUB
11		GND	GND
12		DDC Data	DDC Data
13		Horizontal sync	H/V-Sync
14		Vertical sync	Not Used
15		DDC Clock	DDC Clock

14-5 Timing Chart

This section of the service manual describes the timing that the computer industry recognizes as standard for computer-generated video signals.

Mode Timing	IBM		VESA								
	VGA2/ 70 Hz 720 x 400	VGA3/ 60 Hz 640 x 480	640/75 Hz 640 x 480	800/60 Hz 800 x 600	800/75 Hz 800 x 600	1024/60Hz 1024 x 768	1024/75Hz 1024 x 768	1280/60Hz 1280x1024	1280/75Hz 1280x1024 (Analog Only)	1440/60Hz 1440x900	1440/75Hz 1440x900
fH (kHz)	31.469	31.469	37.500	35.879	46.875	48.363	60.023	63.981	79.976	55.935	75.000
A μsec	31.777	31.778	26.667	26.400	21.333	20.677	16.660	11.852	12.504	17.878	14.157
B μsec	3.813	3.813	2.032	3.200	1.616	2.092	1.219	1.037	1.067	1.427	1.112
C μsec	1.589	1.589	3.810	2.200	3.232	2.462	2.235	2.296	1.837	2.178	1.814
D μsec	26.058	26.058	20.317	20.000	16.162	15.754	13.003	9.259	9.481	13.521	10.530
E μsec	0.318	0.318	0.508	1.000	0.323	0.369	0.203	0.444	0.119	0.751	0.702
fV (Hz)	70.087	59.940	75.000	60.317	75.000	60.004	75.029	60.020	75.025	59.887	75.000
O msec	14.268	16.683	13.333	16.579	13.333	16.666	13.328	60.020	13.329	16.698	13.336
P msec	0.064	0.064	0.080	0.106	0.064	0.124	0.050	0.047	0.038	0.107	0.085
Q msec	0.858	0.794	0.427	0.607	0.448	0.600	0.466	0.594	0.475	0.447	0.467
R msec	13.155	15.761	12.800	15.840	12.800	15.880	12.795	15.630	12.804	16.090	12.741
S msec	0.191	0.064	0.027	0.026	0.021	0.062	0.017	0.016	0.013	0.054	0.042
Clock Freq. (MHz)	28.322	25.175	31.500	40.000	49.500	75.000	78.750	108.000	135.000	106.500	136.750
Polarity H.Sync	Negative	Negative	Negative	Positive	Positive	Negative	Positive	Positive	Positive	Negative	Negative
V.Sync	Positive	Negative	Negative	Positive	Positive	Negative	Positive	Positive	Positive	Positive	Positive
Remark	Separate	Separate	Separate	Separate	Separate	Separate	Separate	Separate	Separate	Separate	Separate

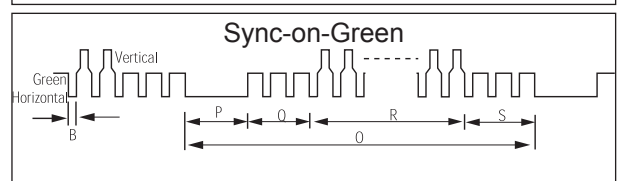
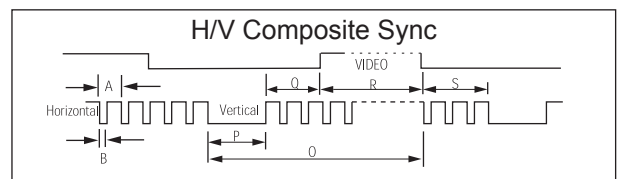
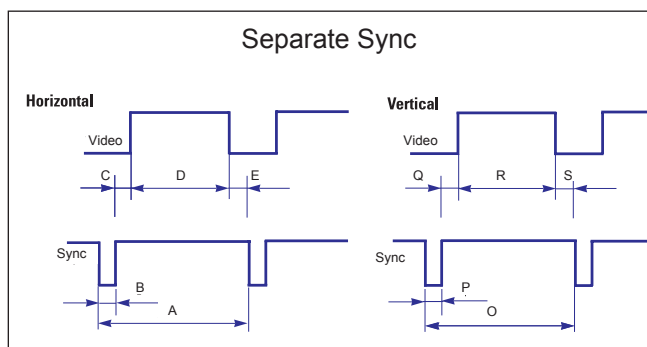

A : Line time total	B : Horizontal sync width	O : Frame time total	P : Vertical sync width
C : Back porch	D : Active time	Q : Back porch	R : Active time
E : Front porch		S : Front porch	

14-6 Preset Timing Modes

-If the signal transferred from the computer is the same as the following Preset Timing Modes, the screen will be adjusted automatically. However, if the signal differs, the screen may go blank while the power LED is on. Refer to the video card manual and adjust the screen as follows.

Table 1. Preset Timing

Display Mode	Horizontal Frequency (kHz)	Vertical Frequency (Hz)	Pixel Clock (MHz)	Sync Polarity (H/V)
MAC, 640 x 480	35.000	66.667	30.240	-/-
MAC, 832 x 624	49.726	74.551	57.284	-/-
MAC, 1152 x 870	68.681	75.062	100.000	-/-
IBM, 640 x 350	31.469	70.086	25.175	+/-
IBM, 640 x 480	31.469	59.940	25.175	-/-
IBM, 720 x 400	31.469	70.087	28.322	-/+
VESA, 640 x 480	37.500	75.000	31.500	-/-
VESA, 640 x 480	37.861	72.809	31.500	-/-
VESA, 800 x 600	35.156	56.250	36.000	+, -/+, -
VESA, 800 x 600	37.879	60.317	40.000	+/+
VESA, 800 x 600	48.077	72.188	50.000	+/+
VESA, 800 x 600	46.875	75.000	49.500	+/+
VESA, 1024 x 768	48.363	60.004	65.000	-/-
VESA, 1024 x 768	56.476	70.069	75.000	-/-
VESA, 1024 x 768	60.023	75.029	78.750	+/+
VESA, 1280 X 960	60.000	60.000	108.00	+/+
VESA, 1280 X1024	63.981	60.020	108.00	+/+
VESA, 1280X1024	79.976	75.025	135.00	+/+
VESA, 1440 x 900	55.935	59.887	106.5	-/+

Horizontal Frequency

The time to scan one line connecting the right edge to the left edge of the screen horizontally is called Horizontal Cycle and the inverse number of the Horizontal Cycle is called Horizontal Frequency. Unit: kHz

Vertical Frequency

Like a fluorescent lamp, the screen has to repeat the same image many times per second to display an image to the user. The frequency of this repetition is called Vertical Frequency or Refresh Rate. Unit: Hz

14-7 Panel Description

Maker	VENDOR_P/N	PANEL_CODE	PANEL_ABB	STICKER_CODE	Remarks
SEC	LT140X1-002	BN07-00004A	SA	BN68-00239H	-
SEC	LT150XS-L01	BN07-00009A	SB		-
SEC	LT150XS-L01-B	BN07-00022A	SC		-
SEC	LTM150XS-L02	BN07-00005A	SD		-
SEC	LT181E2-132	BN07-00001A	SE		-
SEC	LT150XS-T01	BN07-00010A	SF		-
SEC	LTM181E3-132	BN07-00019A	SG		-
SEC	LT170E2-131	BN07-10001D	SH		-
SEC	LT181E2-131	BN07-10001E	SJ		-
SEC	LTM170E4-L01	BN07-00018A	SK		-
SEC	LTM240W1-L01	BN07-00015A	SL		-
SEC	LTM213U3-L01	BN07-00016A	SM		-
SEC	LTM150XH-L01	BN07-00026A	SN		-
SEC	LTM150XH-L03	BN07-00027A	SP		-
SEC	LTM150XS-L01	BN07-00032A	SQ		DELL(ZPD)
SEC	LTM181E4-L01	BN07-00034A	SR		PVA
SEC	LTM170EH-L01	BN07-00036A	SS		TN
SEC	LTM170E5-L01	BN07-00037A	SU		PVA
SEC	LTM150XH-L11	BN07-00041A	SV		-
SEC	LTM213U4-L01	BN07-00039A	SW		PVA
SEC	LTM150XH-L01(ZPD)	BN07-00045A	SX		ZPD
SEC	LTM150XH-L04	BN07-00046A	SY		New panel with high brightness
SEC	LTM170W1-L01	BN07-00047A	SZ		Panel for TV
SEC	LTM150XH-L06	BN07-00053A	EA		Panel for TV/ High Luminance for 450cd _ SONY&EOS Team
Panel for TV					
SEC	LTM153W1-L01	BN07-00054A	EB		Use NIKE MODEL
SEC	LTM170EH-L05	BN07-00055A	EC		Panel EOS proj. for high brightness of 17" EH-L05
SEC	LTM170E5-L03	BN07-00056A	ED		Dell 1702FP pro. E4. EH mechanicalCompatible
SEC	LTM190E1-L01	BN07-00057A	EE		DELL 1900 FP
SEC	LTM181E5-L01	BN07-00061A	EF		18" narrow bezel GH18PS
SEC	LTM150XP-L01	BN07-00065A	EG		AMLCD PVA PANEL
SEC	LTM240W1-L02	BN07-00062A	EH		Panel for 15" Wide TV
SEC	LTM170EU-L01	BN07-00071A	EJ		Slim design, TN
SEC	LTM170E5-L04	BN07-00072A	EK		E5-L04 6 bits FRC... for IBM
SEC	LTA220W1-L01	BN07-00074A	EL		Panel for 22" TV
SEC	LTM170E6-L02	BN07-00075A	EM		AMLCD Narrow & slim design 17" PVAmode
SEC	LTM170W1-L01	BN07-00082A	EN		LTM170W1-L01 ZPD panel
SEC	LTM170EH-L01	BN07-00080A	EP		LTM170EH-L01 ZPD panel
SEC	LTM170E5-L01	BN07-00081A	EQ		LTM170E5-L01 ZPD panel
SEC	LTM170EH-L05	BN07-00083A	ER		LTM170EH-L05 ZPD panel
SEC	LTM170E5-L03	BN07-00084A	ES		LTM170E5-L03 ZPD panel
SEC	LTM170EU-L01	BN07-00085A	ET		LTM170EU-L01 ZPD panel
SEC	LTM170E5-L04	BN07-00086A	EU		LTM170E5-L04 ZPD panel
SEC	LTM170E6-L02	BN07-00087A	EV		LTM170E6-L02 ZPD panel
SEC	LTM150XH-L06	BN07-00091A	EW		Color coordinates change for LCD TV
SEC	LTM153W1-L01	BN07-00092A	EX		AMLCD WIDE 15",9/10
SEC	LTM170W1-L01	BN07-00100A	EY		Color Coordinates change code management
SEC	LTM170EH-L05	BN07-00097A	EZ		LTM170E5-L05 Color Coordinates Change Panel Code
SEC	LTA400W1-L01	BN07-00109A	S1		PANEL of AMLCD 40" TV
SEC	LTM153W1-L01	BN07-00110A	S2		Color coordinates change 0.280/0.290, 10000k & ZPD Panel
SEC	LTM150XH-L06	BN07-00111A	S3		Color coordinates change 0.280/0.290, 10000k & ZPD Panel
SEC	LTM170W1-L01	BN07-00112A	S4		Color coordinates change 0.280/0.290, 10000k & ZPD Panel
SEC	LTM170EH-L05	BN07-00113A	S5		Color coordinates change 0.280/0.290, 10000k & ZPD Panel
SEC	LTM220W1-L01	BN07-00114A	S6		ZPD Panel for AMLCD 22" TV
SEC	LTM150XH-L06	BN07-00117A	S7		ZPD Panel code
SEC	LTM153W1-L01	BN07-00118A	S8		ZPD Panel code
SEC	LTM170WP-L01	BN07-00119A	S9		PVA Panel for NIKE
SEC	LTM213U4-L01	BN07-00039A	E1		21.3" NARROW
SEC	LTA260W1-L01	BN07-00121A	E2		VENUS
SEC	LTA220W1-L01	BN07-00074B	E3		Panel B-level panel code for 22" TV Panel
SEC	LTA320W1-L01	BN07-00108A	E4		Panel for AMLCD 32" TV
SEC	LTM213U4-L01	BN07-00124A	E5		NARROW BEZEL 21 " PANEL

14 Reference Infomation

Maker	VENDOR P/N	PANEL_CODE	PANEL_ABB	STICKER_CODE	Remarks
SEC	LTM170E6-L04	BN07-00129A	E6		HIGHLAND 17" LOW PANEL (Panel only for TCO03)
SEC	LTM190E1-L01	BN07-00088A	E7		LTM190E1-L01 ZPD panel
SEC	M150X4-L06	BN07-00137A	E8		15" Narrow & Slim panel
SEC	LTA170V1	BN07-00139A	E9		17" Panel for Muse 4:3 VGA TV
SEC	LTM190E1-L02	BN07-00128A	E10		New Panel from AMLCDI, Specification : 6bit Driver IC
SEC	LTM170EX-L01	BN07-00143A	E11		Development new Panel from AMLCD
SEC	LTM170E8-L01	BN07-00144A	E12		Development new Panel from AMLCD
SEC	LTM170E6-L04	BN07-00129B	E13		ZPD panel for AMLCD (Panel only for TCO03)
SEC	LTA320W1-L02	BN07-00108B	E14		Creat B-level Panel code for AMLCD 32" TV
SEC	LTM190E1-L03	BN07-00151A	E15		Development new 19" Panel form AMLCD (Panel only for TCO03)
SEC	LTM240W1-L03	BN07-00134A	E16		AMLCD 24" panel development
SEC	LTM190E1-L02	BN07-00128B	E17		New Panel from AMLCD, Specification : 6bit Driver IC(ZPD)
SEC	LTM190E4-L01	BN07-00145A	E18		AMLCD 24" new panel development
SEC	LTM170E8-L01	BN07-00158A	E19		ZPD code derivation
SEC	LTM170EX-L01	BN07-00159A	E20		ZPD code derivation
SEC	LTM190E1-L03	BN07-00151B	E21		Creat new panel code for AMLCD 19" (Panel only for TCO03)
SEC	LTA460H1-L01	BN07-00157A	E22		creat panel code for AMLCD 46" TV
SEC	LTM170EU-L11	BN07-00160A	E23		creat new panel code for AMLCD 17" (Panel only for TCO03)
SEC	LTM240W1-L03	BN07-00134B	E24		24" panel ZPD code derivation
SEC	LTM190E4-L01	BN07-00145B	E25		AMLCD 19" ZPD Panel code derivation
SEC	LTM240W1-L03	BN07-00134B	E26		24" panel ZPD code derivation
SEC	LTM150XO-L01	BN07-00164A	E27		AMLCD 15" XO-L01 new panel development
SEC	LTM150XO-L01	BN07-00164B	E28		AMLCD 15" XO-L01 ZPD code derivation
SEC	LTM170EU-L11	BN07-00160B	E29		AMLCD 17" NEW panel code derivation
SEC	LTA320W2-L01	BN07-00172A	SPZ		AMLCD 32" NEW panel
SEC	LTM213U4-L01	BN07-00124B	SPZ		21.3" Narrow PANEL ZPD Panel derivation
SEC	LTM170EU-L11	BN07-00189A	STH		AMLCD EU-L11 Pb free panel code derivation
SEC	LTM170EU-L11	BN07-00189B	STZ		AMLCD EU-L11 Pb free panel ZPD code derivation
SEC	LTM240W1-L04	BN07-00188A	SPH		24" A-DCC NEW panel
SEC	LTM240W1-L04	BN07-00188B	SPZ		24" A-DCC panel ZPD code derivation
SEC	LTM190EX-L01	BN07-00191A	STH		AMLCD 19" TN NEW Panel
SEC	LTM190EX-L02	BN07-00191B	STZ		AMLCD 19" TN NEW Panel ZPD
SEC	LTA230W1-L02	BN07-00184A	SPZ		AMLCD 23" 16:9 NEW Panel
SEC	LTA260W2-L01	BN07-00185A	SPZ		AMLCD 26" 16:9 NEW Panel
SEC	LTA400W2-L01	BN07-00186A	SPZ		AMLCD 40" 16:9 NEW Panel
SEC	LTM240M1-L01	BN07-00195A	SPH		24" high brightness panel
SEC	LTM150XO-L01	BN07-00197A	STH		AMLCD 15" XO-L01 Pb free panel code
SEC	LTM150XO-L01	BN07-00197B	STZ		AMLCD 15" XO-L01 Pb free panel ZPD code
SEC	LTM170EU-L21	BN07-00202A	STZ		AMLCD EU-L21 ZPD NEW code derivation
SEC	LTA460W2-L03	BN07-00187A	SPZ		BEETOVEN 46"ZPD NEW Panel
SEC	LTM240M1-L01	BN07-00195B	SPZ		24" high brightness panel ZPD code derivation
SEC	M170EX-L21	BN07-00206A	STZ		AMLCD LTM170EX-L21 ZPD NEW code derivation
SEC	LTA460H3-L01	BN07-00200A	SPZ		AMLCD 46" LED BLU panel
SEC	LTM170EU-L15	BN07-00214A	STZ		High brightness For AMLCD EU-L15 TV ZPD NEW code derivation
SEC	LTM170E8-L21	BN07-00218A	SPZ		AMLCD LTM170E8-L21 PVA ZPD NEW code derivation
SEC	LTM190EX-L21	BN07-00222A	STZ		DISPLAY LCD
SEC	LTM201U1-L01	BN07-00190B	SPZ		AMLCD 20.1" Normal panel ZPD code derivation
SEC	LTM190E4-L21	BN07-00223A	SPZ		HAYDN 17" PZD code PANELderivation
SEC	LTA570H1-L01	BN07-00196A	SPZ		AMLCD 57" NEW Panel
SEC	LTM150XO-L21	BN07-00229A	STZ		AMLCD 15" XO-L21 8ms panel code
SEC	LTA260W2-L11	BN07-00239A	SPZ		AMLCD 26" 16:9 7Line NEW Panel
SEC	LTA400WS-LH1	BN07-00245A	SPZ		AMLCD 40" 16:9 SPVA 90% NEW Panel
SEC	LTM213U6-L01	BN07-00231A	SPZ		AMLCD 21.3" PVA NEW Panel Code
SEC	LTM213U6-L01	BN07-00231B	SPH		AMLCD 21.3" PVA Panel HPD Code
SEC	LTA320WS-LH2	BN07-00244A	SPZ		AMLCD 32" 16:9 SPVA 90% NEW Panel
SEC	LTA400WS-LH1	BN07-00245A	SPZ		AMLCD 40" 16:9 SPVA 90% NEW Panel
SEC	LTM190M2-L01	BN07-00227A	STZ		AMLCD 19" TN Wide NEW Panel Code
SEC	LTM201UX-L01	BN07-00249A	STZ		AMLCD 20.1" TN NEW Panel Code
SEC	LTM240M1-L02-A05	BN07-00250A	SPZ		24" High brightness Slim panel ZPD code derivation
SEC	LTA320W3-L02	BN07-00219A	SPZ		AMLCD 32" NEW FFL Panel

Maker	VENDOR P/N	PANEL_CODE	PANEL_ABB	STICKER_CODE	Remarks
SEC	LTA320W2-L11	BN07-00259A	SPZ		IP Board for AMLCD 32" 16:9 NEW Panel
SEC	LTA460WS-L02	BN07-00252A	SPZ		AMLCD 46" 16:9 SPVA 72% NEW Panel
SEC	LTA400WT-L01	BN07-00264A	SPZ		-
SEC	LTM240M2-L02	BN07-00267A	SPZ		All LCD Monitor 24" wide SPVA ZPD NEW code derivation
SEC	LTM210M2-L02	BN07-00230A	SPZ		-
SEC	LTA320WT-L11	BN07-00257A	SPZ		-
SEC	LTM190EX-L21-G	BN07-00274A	STZ		AMLCD 19" TN Glare NEW Panel Code
SEC	LTA320WT-L14	BN07-00247A	SPZ		-
SEC	LTM190M2-L01-D016	BN07-00280A	STZ		AMLCD 19" TN Wide change Gamma Panel Code
SEC	LTM190EX-L31	BN07-00279A	STZ		AMLCD 19" TN NEW Panel Code
SEC	LTM190M2-L02	BN07-00287A	STZ		AMLCD 19" TN Wide High brightness NEW Panel Code
SEC	LTA400WS-L01	BN07-00246A	SPZ		Display-LCD (Div) 07AH
SEC	LTA460WS-L01	BN07-00311A	SPZ		-
SEC	LTM190E4-L31	BN07-00316A	SPZ		-
SEC	LTM170EX-L31	BN07-00278A	STZ		AMLCD LTM170EX-L31 ZPD
SEC	LTA460HS-LH1	BN07-00291A	SPZ		AMLCD 46" 16:9 FHD / 60Hz / 8bit / SPVA 92%
SEC	LTA320WT-LF1	BN07-00323A	SPZ		-
SEC	LTA460WT-L02	BN07-00284A	SPZ		AMLCD 46" 16:9 HD / 60Hz / 8bit / SPVA 72% /
SEC	LTA400WH-LH1	BN07-00271A	SPZ		AMLCD 40" 16:9 SPVA 92% 10bit 120Hz
SEC	LTM240M1-L02-D015	BN07-00331A	SPZ		-
SEC	LTM300M1-P01	BN07-00326A	SPZ		-
CPT	CLAA150XG09	BN07-00141A	PA		CPT 15" Monitor new panel development
CPT	CLAA170EA02	BN07-00148A	PB		17" CPT NEW development panel
CPT	CLAA170EA02	BN07-00148B	PC		17" CPT ZPD panel code derivation
CPT	CLAA150XG09	BN07-00141B	PTZ		CPT 15" panel ZPD code derivation (GOYA-PJT)
CPT	CLAA150XP01	BN07-00173A	PTH		CPT 15" PSWG code derivation
CPT	CLAA150XP01	BN07-00173B	PTZ		CPT 15" PSWG panel ZPD code derivation
CPT	CLAA170EA07	BN07-00174A	PTH		CPT 17" PSWG code derivation
CPT	CLAA170EA07	BN07-00174B	PTZ		CPT 17" PSWG type New Panel code
CPT	CLAA170EA07Q	BN07-00220A	PTZ		CPT 17" PSWG R/T 8msec code derivation
CPT	CLAA170EA07Q	BN07-00220B	PTH		CPT 17" PSWG R/T 8msec HPD code derivation
CPT	CLAA150XP01F	BN07-00236A	PTZ		CPT 15" PSWG panel ZPD & Lead free code derivation
CPT	CLAA201WA03Q	BN07-00269A	PTZ		CPT 20.1" wide TN ZPD New code derivation
CPT	CLAA320WA01	BN07-00276A	PMZ		CPT 32" 16:9 MVA 8bit 60Hz / Panel brown
CPT	CLAA170ES01	BN07-00261A	PTZ		CPT 17" Slim TN ZPD Type New code derivation
CPT	CLAA070VA02	BN07-00265A	PTZ		CPT Panel code derivation for Digital Album
TOSHIBA	LTM15C419(A)	BN07-00002A	TA		-
TOSHIBA	LTM15C423(B)	BN07-00006A	TB		-
TOSHIBA	LTM18C161	BN07-00008A	TC		-
TOSHIBA	LTM15C443	BN07-00031A	TD		-
TOSHIBA	LTM15C458	BN07-00043A	TE		-
TOSHIBA	LTM15C458S	BN07-00077A	TF		TSB 15" high brightness Panel
TOSHIBA	LTM15C458	BN07-00078A	TG		Toshiba ZPD panel
TOSHIBA	LTM15C458S	BN07-00099A	TH		TSB LTM15C458S (ZPD)
HANNSTAR	HSD150MX41A(A)	BN07-00020A	NA		TTL type
HANNSTAR	HSD150MX12	BN07-00030A	NB		TTL type
HANNSTAR	HSD170ME13	BN07-00180A	NTH		Hannstar 17" TN new panel development
HANNSTAR	HSD170ME13	BN07-00180B	NTZ		Hannstar 17" TN new panel development ZPD code deriva-
HANNSTAR	HSD190ME12	BN07-00210A	NTZ		Hannstar 19" TN new panel development
HANNSTAR	HSD150MX17-A	BN07-00226A	NTZ		Hannstar 15" slim panel ZPD code derivation
HANNSTAR	HSD190ME12-A10	BN07-00256A	NTZ		Hannstar 19" TN PSWG 8ms new panel development
HANNSTAR	HSD190ME13-D11	BN07-00270A	NTZ		Hannstar 19" TN Slim 5ms new panel development
HANNSTAR	HSD190ME13-A13	BN07-00317A	NTZ		
TORISAN	TM150XG-22L03(A)	BN07-00021A	RA		-
TORISAN	TM150XG-26L06	BN07-00042A	RB		-
TORISAN	TM181SX-76N01	BN07-00048A	RC		-
TORISAN	TM150XG-26L06	BN07-00059A	RD		15" XGA TN MODE(ZPD)

14 Reference Information

Maker	VENDOR P/N	PANEL_CODE	PANEL_ABB	STICKER_CODE	Remarks
TORISAN	TM290WX-71N31	BN07-00063A	RE		RS24NS (TORISAN 29" NEW PANEL)
TORISAN	TM396WX-71N31	BN07-00064A	RF		RS24NS (TORISAN 40" NEW PANEL)
TORISAN	TM150XG-26L09	BN07-00073A	RG		Panel for 15" TV
TORISAN	TM150XG-26L10	BN07-00089A	RH		L10(change except D/I/C) ZPD
TORISAN	TM150XG-26L10	BN07-00090A	RJ		L10 NORMAL
TORISAN	TM190SX-70N01	BN07-00098A	RK		Torisan 19" Panel
TORISAN	TM181SX-76N01	BN07-00106A	RL		ZPD Panel code
TORISAN	TM190SX-70N01	BN07-00107A	RM		ZPD Panel code
TORISAN	TM290WX-71N31	BN07-00115A	RN		Color Coordinates change panel for TORISAN 29" TV
TORISAN	TM396WX-71N31	BN07-00116A	RP,Q		Color Coordinates change panel for TORISAN 40" TV
TORISAN	TM220WX-71N31	BN07-00125A	RR		Development TORISAN 22" TV PANEL (ZPD)
TORISAN	TM220WX-71N31	BN07-00127A	RS		Development TORISAN 22" TV PANEL (HPD)
TORISAN	TM396WX-71N32A	BN07-00150A	RT		120V inverter Exclusive panel
TORISAN	TM190SX-70N02	BN07-00154A	RMH		Torisan 6bit panel code Derivation
TORISAN	TM190SX-70N02	BN07-00154B	RMZ		Torisan 6bit panel code Derivation
TORISAN	TM150XG-A01	BN07-00162A	RTH		Torisan 15" Narrow & Slim panel development
TORISAN	TM150XG-A01	BN07-00162B	RTZ		Torisan 15" N&S panel ZPD code derivation
SHARP	LQ181E1DG11(A)	BN07-10001C	PA		-
SHARP	LQ150X1LW71	BN07-00067A	PB		SHARP 15" PVA PANEL
SHARP	LQ370T3LZ41	BN07-00216A	FAZ		Rome2
HITACHI	TX38D12VC0CAA(A)	BN07-00003A	HA		-
HITACHI	TX43DVCOCAB	BN07-00060A	HB		17" SXGA PVA MODE
HITACHI	TX43D15VCOCAB	BN07-00101A	HC		ZPD Panel
HITACHI	TX51D11VCOCAB	BN07-00122A	HD		20.1" NARROW
HITACHI	TX54D11VCOCAB	BN07-00123A	HE		21.3" NARROW
HITACHI	TX80D12VCOCAB	BN07-00169A	HIZ		Development new panel for Hitachi 32" TV (ZPD)
HITACHI	TX54D11VCOCAB	BN07-00123B	HIZ		Hitachi 21.3"ZPD panel
IBM	ITSX94S	BN07-00017A	IA		-
UNIPAC	UM170E0	BN07-00028A	UA		Loaded by cisdba
HYUNDAI	HT15X13	BN07-00035A	DA		-
HYUNDAI	HT17E11-200	BN07-00049A	DB		TN MODE
HYUNDAI	HT17E11-300	BN07-00093A	DC		HT17E11-300 ZPD panel
HYUNDAI	HT17E11-400	BN07-00094A	DD		HT17E11-400 normal panel
HYUNDAI	HT17E11-400	BN07-00095A	DE		HT17E11-400 ZPD panel code
HYUNDAI	HT17E12	BN07-00096A	DF		HT17E12 (Narrow & slim Design)
HYUNDAI	HT17E12	BN07-00105A	DG		ZPD Panel code
HYUNDAI	HT15X15-D00	BN07-00146A	DH		Development for Ares 15" Hydis TV
HYUNDAI	HT15X15-D01	BN07-00146B	DJ		Derivation panel HPD for Ares 15" Hydis TV
HYUNDAI	HT17E13-100	BN07-00167A	DTH		PINEHURST-2(IBM) PJT 17" HYDIS PANEL Derivation
HYUNDAI	HT17E13-100	BN07-00167B	DTZ		PINEHURST-2(IBM) Hydis 17" ZPD code Derivation
HYUNDAI	HT170EX1-100	BN07-00240A	DTZ		17" EX compatible Hydis Slim panel development
HYUNDAI	HT201V01-100	BN07-00263A	DTZ		Hydis 20.1" 4:3 VGA Mode TN NEW Panel
HYUNDAI	HT170EX1-101	BN07-00266A	DTZ		17" EX compatible Hydis Slim panel multi channel IC NEW Derivation
ACER	L170E3	BN07-00044A	AA		TN(ADT)
ACER	M170EN05	BN07-00076A	AB		AU 17" Panel (Narrow & slim design)
ACER	M170EN05	BN07-00102A	AC		ZPD Panel code
ACER	M190EN02	BN07-00170A	AMH		AU Monitor 19" new panel development (P19-1S)
ACER	M190EN02	BN07-00170B	AMZ		AU 19" ZPD code derivation (ZPD)
ACER	M170EN06	BN07-00171A	ATH		AU Monitor 17" New panel development
ACER	T260XW01	BN07-00163A	AMZ		AU 26" new panel development (NF26EO)
ACER	A201SN01	BN07-00177A	ATZ		AU TV panel 20.1" TN SVGA new panel development
ACER	M170EN06	BN07-00171B	ATZ		AU Monitor 17" ZPD code Derivation
ACER	T315XW01	BN07-00194A	AMZ		New AU 32"
ACER	M170EG01	BN07-00192A	ATH		AU TN PSWG type New Panel code
ACER	M170EG01	BN07-00192B	ATZ		AU TN PSWG type New Panel ZPD Derivation code

Maker	VENDOR P/N	PANEL_CODE	PANEL_ABB	STICKER_CODE	Remarks
ACER	M190EN04	BN07-00203A	ATH		AU Monitor 19" ZPD New code Derivation
ACER	T260XW02	BN07-00208A	AMZ		AUO 26"
ACER	M170EG01 V8	BN07-00221A	ATZ		AU TN PSWG type New Panel (8msec) ZPD Derivation code
ACER	T260XW02	BN07-00233A	AMZ		AUO 26" New Panel (Cosmetic spec down grade)
ACER	T315XW01	BN07-00234A	AMZ		AUO 32" New Grade (Cosmetic spec down grade)]
ACER	M190EN03	BN07-00224A	AMZ		AU Monitor 19" MVA New code Derivation
ACER	T315XW01	BN07-00237A	AMZ		New LCD TV VE project : delete DBEF sheet * Panel, model
ACER	T315XW01	BN07-00238A	AMZ		New LCD TV VE project : delete DBEF sheet + 'A-
ACER	M201UN02 V3	BN07-00168A	AMZ		-
ACER	M201UN02 V3	BN07-00168B	AMH		-
ACER	M190EN04 V7	BN07-00248A	ATZ		AU Monitor 19" TN Glare ZPD New code Derivation
ACER	A070VW01	BN07-00235A	ATZ		New Panel code Derivation for Digital Album
ACER	T315XW01	BN07-00253A	AMZ		LCD TV VE item model * Panel, Model division add version:
ACER	T260XW02	BN07-00254A	AMZ		AUO 26" VE item apply model
ACER	M170EU01	BN07-00260A	ATZ		AUO 17" Slim TN ZPD Type New code Derivation
ACER	T370XW01	BN07-00255A	AMZ		for ROME 37" model development
ACER	T315XW02(V3),	BN07-00324A	AMZ		-
ACER	A201SN02 V5	BN07-00314A	ATZ		-
CHIMEI	M170E3-L01	BN07-00050A	CA		TN PANEL
CHIMEI	M150X3-L01	BN07-00051A	CB		COMPATIBLE
CHIMEI	M170E4-L01	BN07-00052A	CC		MVA PANEL
CHIMEI	M150X2-L01	BN07-00066A	CD		CHIME 15" PVA PANEL
CHIMEI	M150X3-L01	BN07-00079A	CE		Chimei ZPD panel
CHIMEI	M170E3-L01	BN07-00103A	CF		ZPD Panel code
CHIMEI	M170E4-L01	BN07-00104A	CG		ZPD Panel code
CHIMEI	V296W1-L01	BN07-00120A	CH		MVA
CHIMEI	M170E6-L02	BN07-00126A	CJ		HIGHLAND 17" LOW PANEL
CHIMEI	M190E2-L01	BN07-00131A	CK		GH19AS,BS CHIMEI PANEL
CHIMEI	M150X4-L06	BN07-00137A	CL		15" Narrow & Slim panel
CHIMEI	M170E6-L01	BN07-00133A	CM		2003-03-11 vendor change
CHIMEI	M170E6-L01	BN07-00133B	CN		ZPD derivation panel
CHIMEI	V201V1-T01	BN07-00135A	CP		CHIMEI 20.1" panel development
CHIMEI	M170E6-L02	BN07-00126B	CQ		HIGHLAND 17" LOW PANEL ZPD derivation panel
CHIMEI	M170E6-L05	BN07-00152A	CR		CMO 17" new panel development code
CHIMEI	M170E6-L05	BN07-00152B	CS		CMO 17" ZPD panel code derivation
CHIMEI	M150X4-L06	BN07-00137B	CT		Chimei 15" Narrow & Slim panel ZPD derivation
CHIMEI	M170E5-L05	BN07-00165A	CTH		CMO 17" new panel development code (GOYA2-PJT)
CHIMEI	M170E5-L05	BN07-00165B	CTZ		CMO 17" ZPD panel(GOYA2-PJT)
CHIMEI	V230W1-L02	BN07-00209A	CMZ		CMO 23" new development
CHIMEI	V320B1-L01	BN07-00207A	CMZ		CMO 32" new development
CHIMEI	V270W1-L01	BN07-00136A	CMZ		CHI MEI 27" panel development
CHIMEI	M190E5-L0A	BN07-00213A	CTZ		-
CHIMEI	M190E3-L0A	BN07-00212A	CMZ		CMO M190E3-L0A MVA Type New code derivation
CHIMEI	M170E7-L01	BN07-00232A	CTZ		CMO 17" Slim TN ZPD Type New code derivation
CHIMEI	M190A1-L01	BN07-00228A	CTZ		CMO 19" Wide TN ZPD Type New code derivation
CHIMEI	V201V1-T03	BN07-00275A	CTZ		CMO 20.1" (V201V1-T01) VE model
CHIMEI	M201P1-L01	BN07-00268A	CTZ		CMO 20.1" TN ZPD derivation
CHIMEI	M220Z1-L01	BN07-00321A	CTZ		
CHIMEI	M190E5-LOG	BN07-00337A	CTZ		
NEC	SVA150XG04TB	BN07-00225A	BTZ		SVA NEC 15" panel ZPD code
NEC	SVA170SX01TB	BN07-00272A	BTZ		SVA NEC 17" panel ZPD code Brown

Memo