

DESCRIPTION

- 249.6 MHz SAW bandpass filter with 5 MHz bandwidth.
- 9.1 x 4.8 mm ceramic LCC package.
- RoHS compliant.

TYPICAL PERFORMANCE

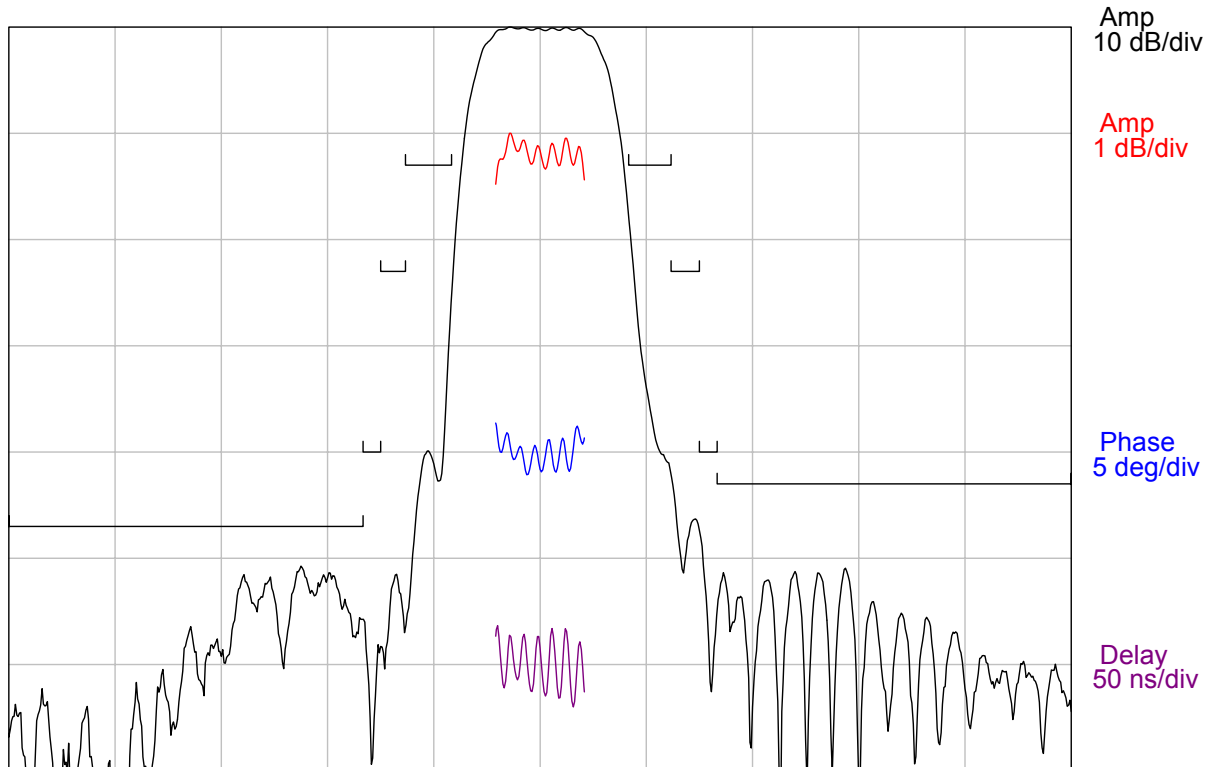

S11 (219.6-279.6 MHz)

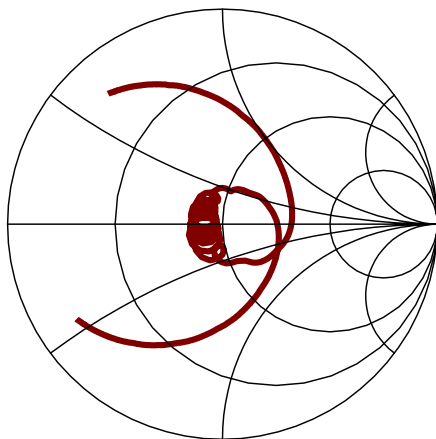

S22 (219.6-279.6 MHz)

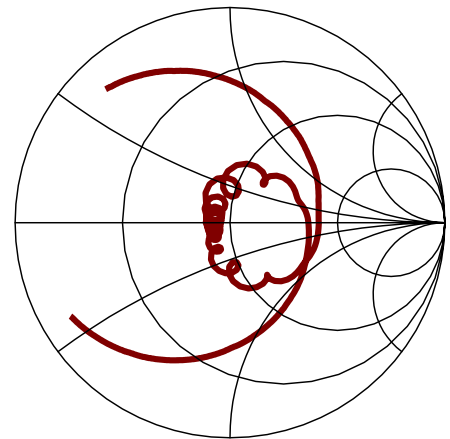

SPECIFICATION

Parameter	Min	Typ	Max	Units
Center Frequency, F_c ¹	-	249.6	-	MHz
Insertion Loss	-	8.6	12	dB
Amplitude variation (247.1 to 252.1 MHz)	-	0.8	1.1	dB p-p
Phase Linearity (247.1 to 252.1 MHz)	-	0.7	4	deg RMS
Absolute Delay	-	635	-	ns
Lower 1dB Band Edge ²	-	246.8	247.1	MHz
Upper 1dB Band Edge ²	252.1	252.6	-	MHz
Relative Attenuation (149.6 to 239.6 MHz) ²	47	50	-	dB
Relative Attenuation (239.6 to 240.6 MHz) ²	40	52	-	dB
Relative Attenuation (240.6 to 242 MHz) ²	23	48	-	dB
Relative Attenuation (242 to 244.6 MHz) ²	13	25	-	dB
Relative Attenuation (254.6 to 257 MHz) ²	13	18	-	dB
Relative Attenuation (257 to 258.6 MHz) ²	23	42	-	dB
Relative Attenuation (258.6 to 259.6 MHz) ²	40	47	-	dB
Relative Attenuation (259.6 to 349.6 MHz) ²	43	50	-	dB
Source and Load Impedance	50			ohms
Temperature Coefficient of Frequency	-18			ppm/°C
Ambient Temperature	-	25	-	°C

- Notes:
1. Reference frequency. Computed as mean of the 3 dB frequencies.
 2. All dB values are referenced to the insertion loss value.
 3. Input IP3 is +37.5 dBm minimum measured with two tones at 249.5 and 249.7 MHz, -3.5 dBm each tone.

MAXIMUM RATINGS

Parameter	Min	Max	Units
Storage Temperature Range	-40	85	°C
Operating Temperature Range	-20	85	°C
Input Power Level	-	10	dBm

MATCHING CIRCUIT

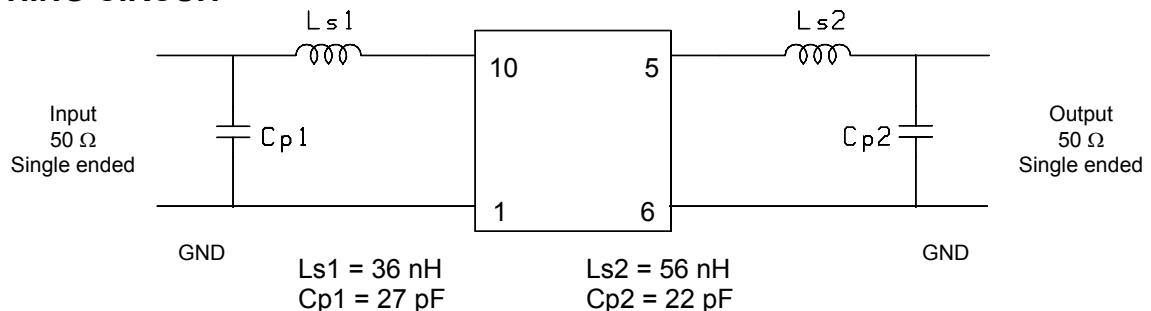

Notes:

- Recommend 2% or better tolerance matching components. Typical inductor Q=40.
- Optimum values may change depending on board layout. Values shown are intended as a guide only.

PACKAGE OUTLINE

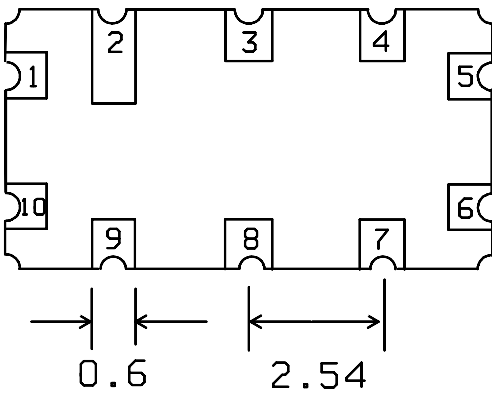
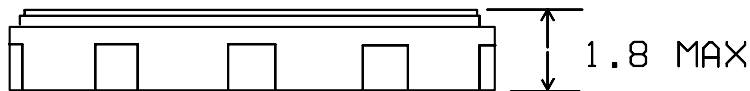
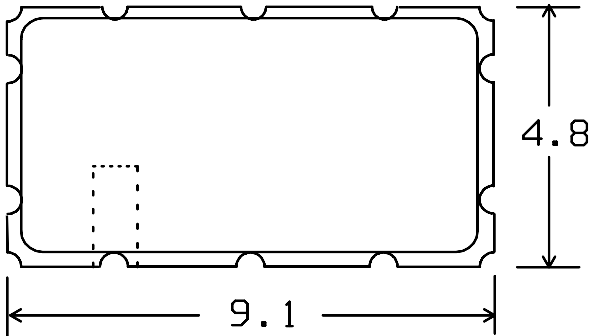

Units: mm

Tolerances are typically ± 0.15 mm except where indicated.

Pad Configuration:

Input: 10
 Output: 5
 Ground: All other pads

Package Material:
 Body: Al_2O_3 ceramic
 Lid: Kovar, Ni plated
 Terminations: Au plating 1 μ m min,
 over a 1.3-8.9 μ m Ni plating

ISO 9001
 Registered

All specifications are believed to be accurate and reliable. However, Spectrum Microwave reserves the right to make changes without notice.
 © 2010 All rights reserved.