

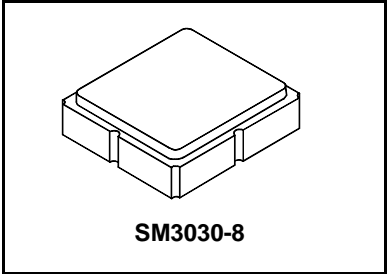

SF2165E

1586.36 MHz SAW Filter



- SAW Filter for Digital Television
- Complies with Directive 2002/95/EC (RoHS)



Characteristics:

Differential Source and Load Configuration

Terminating Source/Load Impedance : $Z_S = 150 \Omega$

Maximum Rating

Rating	Value	Units
Input Power Level	10	dBm
DC Voltage on any Non-ground Terminal	3	V
Operating Temperature Range	-40 to +85	°C
Storage Temperature Range	-50 to +95	°C
Suitable for Lead-free Soldering - Maximum Soldering Profile	260°C for 30 s	

Electrical Characteristics

Characteristic	Sym	Notes	Min	Typ	Max	Units
Center Frequency	f_c			1586.36		MHz
Insertion Loss, 1566.36 to 1606.36 MHz	IL			1.8	4.5	dB
Amplitude Ripple, 1566.36 to 1606.36 MHz		1		1.0	2.0	dB
Phase Error, 1566.36 to 1606.36 MHz		1		3.5	6.0	deg
Input/Output VSWR, 1566.36 to 1606.36 MHz				1.5:1	2.5:1	
2 dB Bandwidth			40	59		MHz
Attenuation, Referenced to 0 dB						
50 to 1504.3 MHz			46	58		dB
1668.42 to 1810.5 MHz			46	60		
1810.5 to 4250 MHz			35	60		
4250 to 6000 MHz			30	38		

Case Style	SM3030-8 3.0 x 3.0 mm Nominal Footprint		
Lid Symbolization (Y=year, WW=week, S=shift) dot=pin 1 indicator	861, YWWS		
Standard Reel Quantity	Reel Size 7 Inch	500 Pieces/Reel	
	Reel Size 13 Inch	3000 Pieces/Reel	

Electrical Connections

	Connection	Terminals
Port 1	Balanced Input	1,2
Port 2	Balanced Output	5,6
	Ground	All Others

Dot Indicates Pin 1



CAUTION: Electrostatic Sensitive Device. Observe precautions for handling.

Notes:

1. Specification applies to any 30 MHz segment in the passband.
2. US and international patents may apply.
3. RFM, stylized RFM logo, and RF Monolithics, Inc. are registered trademarks of RF Monolithics, Inc.

Filter S_{11} , S_{22} and S_{21} Parameters

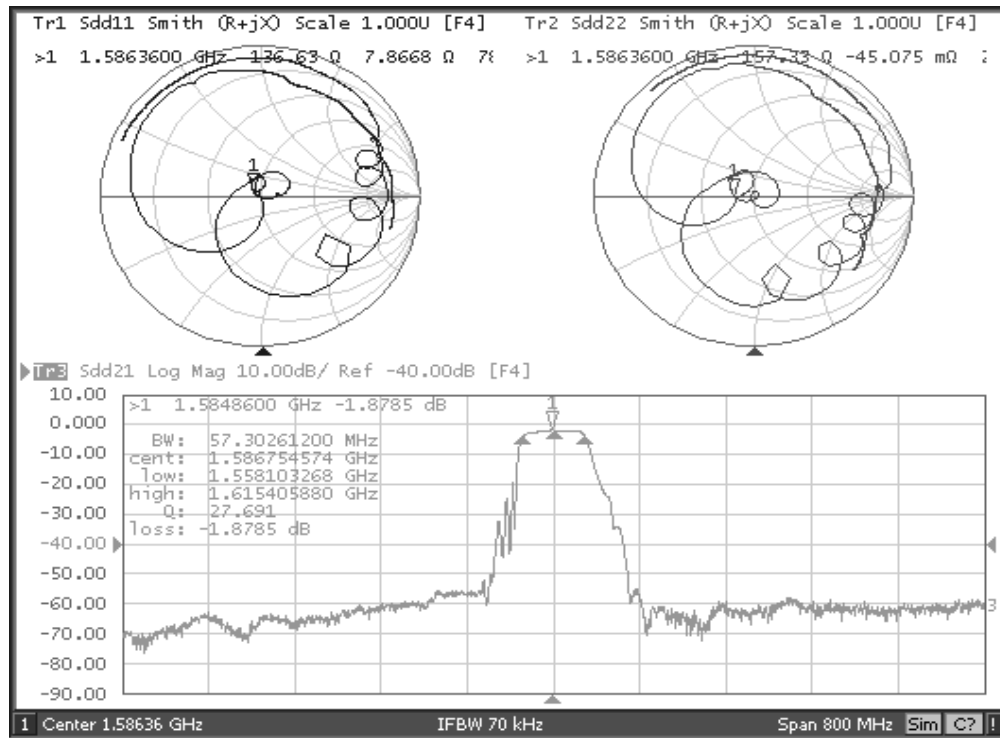

Filter SWR and Passband Response

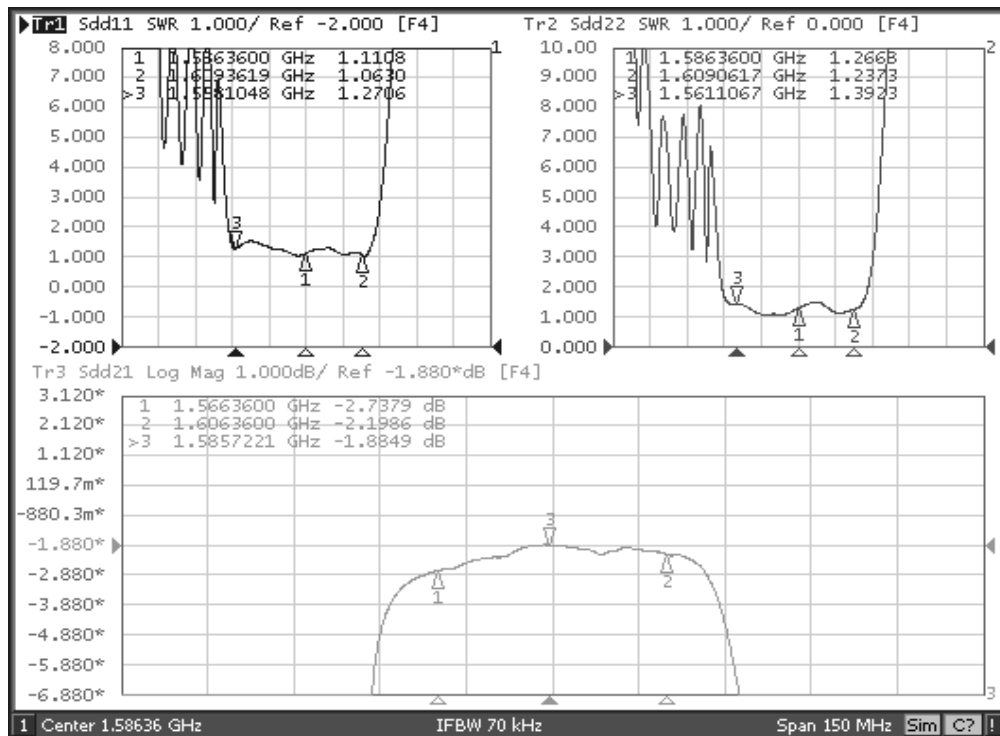

8-Terminal Ceramic Surface-Mount Case 3.0 X 3.0 mm Nominal Footprint

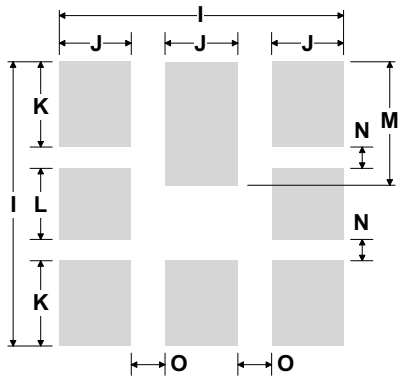
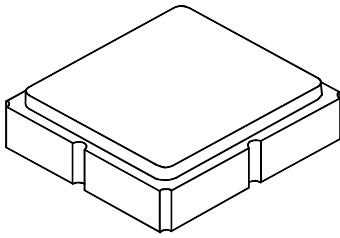

PCB Footprint Top View

Case and PCB Footprint Dimensions

Dimension	mm			Inches		
	Min	Nom	Max	Min	Nom	Max
A	2.87	3.0	3.13	0.113	0.118	0.123
B	2.87	3.0	3.13	0.113	0.118	0.123
C	1.14	1.27	1.40	0.045	0.050	0.055
D	0.79	0.92	1.05	0.031	0.036	0.041
E	0.62	0.75	0.88	0.024	0.029	0.034
F	0.47	0.60	0.73	0.018	0.024	0.029
G	0.47	0.60	0.73	0.018	0.024	0.029
H	1.07	1.20	1.33	0.042	0.047	0.052
I		3.19			0.126	
J		0.81			0.032	
K		0.96			0.038	
L		0.81			0.032	
M		1.39			0.055	
N		0.23			0.009	
O		0.38			0.015	

Case Materials

Materials	
Solder Pad Plating	0.3 to 1.0 μm Gold over 1.27 to 8.89 μm Nickel
Lid Plating	2.0 to 3.0 μm Nickel
Body	Al_2O_3 Ceramic
	Pb Free

TOP VIEW

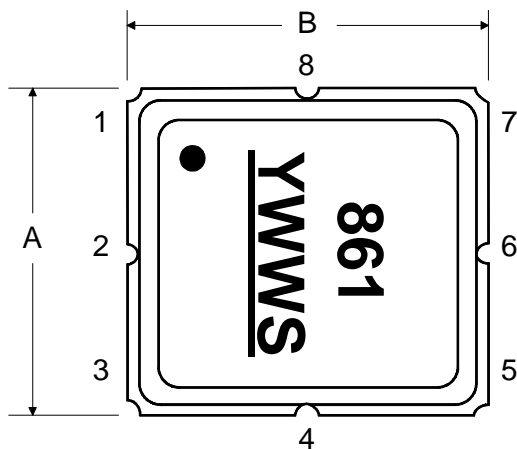

BOTTOM VIEW

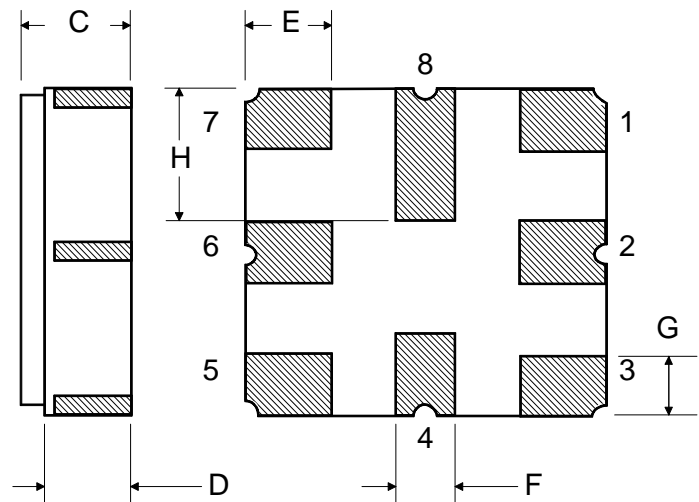

Tape and Reel Specifications

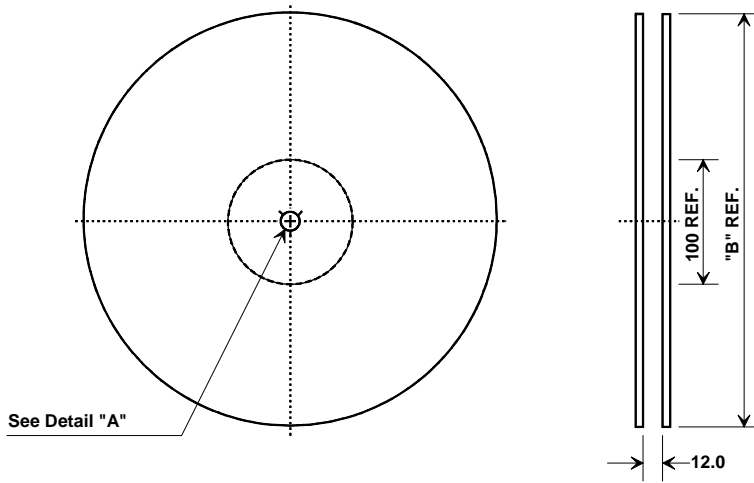

See Detail "A"

"B"		Quantity Per Reel
Inches	millimeters	
7	178	500
13	330	3000

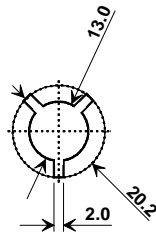

Carrier Tape Dimensions	
Ao	3.35 mm
Bo	3.35 mm
Ko	1.4 mm
Pitch	8.0 mm
W	12.0 mm

COMPONENT ORIENTATION and DIMENSIONS

