

## 3W Mono Fully Differential Audio Power Amplifier

### Features

- **Operating Voltage: 2.4V~5.5V**
- **Fully Differential Class-AB Amplifier**
- **High PSRR and Excellent RF Rectification Immunity**
- **Low Crosstalk**
- **3W Output Power into 3W Load at  $V_{DD}=5V$**
- **Thermal and Over-Current Protections**
- **Built-in Feedback Resistors Eliminate External Components Counts**
- **Space Saving Package**
  - MSOP-8
  - MSOP-8P
  - TDFN3x3-8
- **Lead Free and Green Devices Available (RoHS Compliant)**

### Applications

- Mobil Phones
- Portable Devices

### Simplified Application Circuit

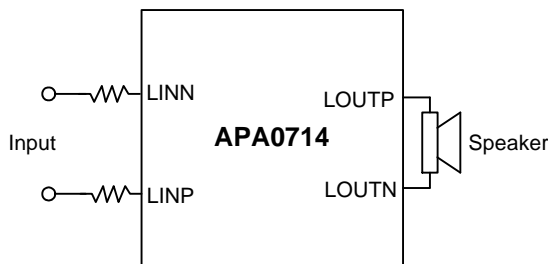

### General Description

The APA0714 is a Mono, fully differential Class-AB audio amplifier which can operate with supply voltage from 2.4V to 5V and is available in MSOP8, MSOP8P, or TDFN3x3-8 package.

The built-in feedback resistors can minimize the external component count and save the PCB space. High PSRR and fully differential architecture increase immunity to noise and RF rectification. In addition to these features, a short startup time and small package size make the APA0714 an ideal choice for Mobil Phones and Portable Devices.

The APA0714 also integrates the de-pop circuitry that reduces the pops and click noises during power on/off and shutdown mode operation. Both Thermal and over-current protections are integrated to avoid the IC to be destroyed by over temperature and short-circuit.

The APA0714 is capable of driving 3W at 5V into 3Ω speaker.

### Pin Configuration

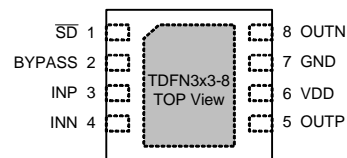
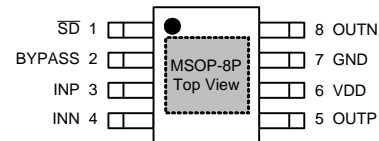
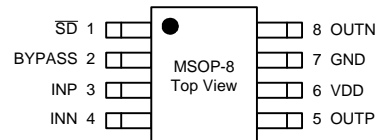

 = Thermal Pad (connected the Thermal Pad to GND plane for better heat dissipation)

ANPEC reserves the right to make changes to improve reliability or manufacturability without notice, and advise customers to obtain the latest version of relevant information to verify before placing orders.

## Ordering and Marking Information

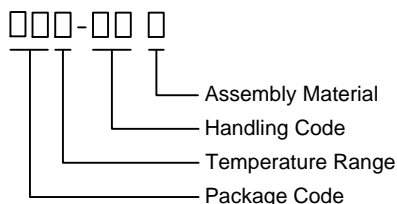
|              |   |   |      |         |                   |
|--------------|---|---|------|---------|-------------------|
| APA0714      |    | Package Code<br>X : MSOP-8    XA : MSOP-8P    QB : TDFN3x3-8<br>Operating Ambient Temperature Range<br>I : -40 to 85 °C<br>Handling Code<br>TR : Tape & Reel<br>Assembly Material<br>G : Halogen and Lead Free Device |      |         |                   |
| APA0714 X :  | <table border="1" style="border-collapse: collapse; text-align: center;"> <tr><td>A0714</td></tr> <tr><td>XXX</td></tr> <tr><td>• XX</td></tr> </table>   | A0714   | XXX  | • XX    | XXXXX - Date Code |
| A0714        |   |   |      |         |                   |
| XXX          |   |   |      |         |                   |
| • XX         |   |   |      |         |                   |
| APA0714 XA : | <table border="1" style="border-collapse: collapse; text-align: center;"> <tr><td>A0714</td></tr> <tr><td>XXX</td></tr> <tr><td>• XX</td></tr> </table>   | A0714   | XXX  | • XX    | XXXXX - Date Code |
| A0714        |   |   |      |         |                   |
| XXX          |   |   |      |         |                   |
| • XX         |   |   |      |         |                   |
| APA0714 QB : | <table border="1" style="border-collapse: collapse; text-align: center;"> <tr><td>APA</td></tr> <tr><td>0714</td></tr> <tr><td>• XXXXX</td></tr> </table> | APA   | 0714 | • XXXXX | XXXXX - Date Code |
| APA          |   |   |      |         |                   |
| 0714         |   |   |      |         |                   |
| • XXXXX      |   |   |      |         |                   |

Note : ANPEC lead-free products contain molding compounds/die attach materials and 100% matte tin plate termination finish; which are fully compliant with RoHS. ANPEC lead-free products meet or exceed the lead-free requirements of IPC/JEDEC J-STD-020D for MSL classification at lead-free peak reflow temperature. ANPEC defines “Green” to mean lead-free (RoHS compliant) and halogen free (Br or Cl does not exceed 900ppm by weight in homogeneous material and total of Br and Cl does not exceed 1500ppm by weight).

## Absolute Maximum Ratings (Note 1)

| Symbol    | Parameter  | Rating                 | Unit |
|-----------|--|------------------------|------|
| $V_{DD}$  | Supply Voltage                                   | -0.3 to 6              | V    |
| $V_{IN}$  | Input Voltage (INN, INP, $\overline{SD}$ to GND) | -0.3 to 6              | V    |
|           | Input Voltage (OUTN, OUTP to GND)                | -0.3 to $V_{DD} + 0.3$ |      |
| $T_J$     | Maximum Junction Temperature                     | 150                    | °C   |
| $T_{STG}$ | Storage Temperature Range                        | -65 to +150            | °C   |
| $T_{SDR}$ | Maximum Soldering Temperature Range, 10 Seconds  | 260                    | °C   |
| $P_D$     | Power Dissipation                                | Internally Limited     | W    |

Note 1: Absolute Maximum Ratings are those values beyond which the life of a device may be impaired. Exposure to absolute maximum rating conditions for extended periods may affect device reliability.

## Thermal Characteristics

| Symbol        | Parameter   | Typical Value | Unit |
|---------------|---|---------------|------|
| $\theta_{JA}$ | Thermal Resistance -Junction to Ambient <sup>(Note 2)</sup> | MSOP-8        | 200  |
|               |   | MSOP-8P       | 50   |
|               |   | TDFN3x3-8     | 52   |
| $\theta_{JC}$ | Thermal Resistance -Junction to Case <sup>(Note 3)</sup>    | MSOP-8P       | 10   |
|               |   | TDFN3x3-8     | 11   |

Note 2: Please refer to “Layout Recommendation”, the Thermal Pad on the bottom of the IC should soldered directly to the PCB's ThermalPad area that with several thermal vias connect to the ground plan, and the PCB is a 2-layer, 5-inch square area with 2oz copper thickness.

Note 3: The case temperature is measured at the center of the Thermal Pad on the underside of the MSOP-8P and TDFN3x3-8 package.

## Recommended Operating Conditions

| Symbol          | Parameter                            | Rating                     | Unit |
|-----------------|--------------------------------------|----------------------------|------|
| V <sub>DD</sub> | Supply Voltage                       | 2.4 ~ 5.5                  | V    |
| V <sub>IH</sub> | High Level Threshold Voltage         | 1.8 ~ V <sub>DD</sub>      | V    |
| V <sub>IL</sub> | Low Level Threshold Voltage          | 0 ~ 0.35                   | V    |
| V <sub>IC</sub> | Common Mode Input Voltage            | 0.5 ~ V <sub>DD</sub> -0.5 | V    |
|                 | Operating Ambient Temperature Range  | -40 ~ 85                   | °C   |
|                 | Operating Junction Temperature Range | -40 ~ 125                  | °C   |
|                 | Speaker Resistance                   | 3 ~                        | Ω    |

## Electrical Characteristics

V<sub>DD</sub>=5V, GND=0V, T<sub>A</sub>= 25°C (unless otherwise noted)

| Symbol                                       | Parameter                             | Test Conditions  | APA0714                                    |                         |                         | Unit     |   |
|--|---------------------------------------|--|--|-------------------------|-------------------------|----------|---|
|  |                                       |  | Min.                                       | Typ.                    | Max.                    |          |   |
| I <sub>DD</sub>                              | Supply Current                        |  | -  | 3                       | 6                       | mA       |   |
| I <sub>SD</sub>                              | Shutdown Current                      | LSD=RSD=0V   | -  | -                       | 5                       | μA       |   |
| I <sub>I</sub>                               | Input Current                         | LSD, RSD   | -  | 0.1                     | -                       | μA       |   |
| Gain   |                                       | R <sub>L</sub> =4Ω   | $\frac{36k\Omega}{R_i}$                    | $\frac{40k\Omega}{R_i}$ | $\frac{44k\Omega}{R_i}$ | V/V      |   |
| T <sub>START-UP</sub>                        | Start-Up Time from End of Shutdown    | C <sub>b</sub> =0.22μF   | -  | 65                      | -                       | ms       |   |
| R <sub>SD</sub>                              | Resistance from Shutdown to GND       |  | 90   | 100                     | 110                     | kΩ       |   |
| <b>V<sub>DD</sub>=5V, T<sub>A</sub>=25°C</b> |                                       |  |  |                         |                         |          |   |
| P <sub>O</sub>                               | Output Power                          | THD+N=1%   | R <sub>L</sub> =3Ω                         | -                       | 2.4                     | -        | W |
|  |                                       |  | R <sub>L</sub> =4Ω                         | -                       | 2.1                     | -        |   |
|  |                                       |  | R <sub>L</sub> =8Ω                         | 1                       | 1.3                     | -        |   |
|  |                                       | THD+N=10%<br>f <sub>in</sub> =1kHz   | R <sub>L</sub> =3Ω                         | -                       | 3                       | -        |   |
|  |                                       |  | R <sub>L</sub> =4Ω                         | -                       | 2.6                     | -        |   |
|  |                                       |  | R <sub>L</sub> =8Ω                         | -                       | 1.6                     | -        |   |
| THD+N  | Total Harmonic Distortion Pulse Noise | f <sub>in</sub> =1kHz  | R <sub>L</sub> =4Ω<br>P <sub>O</sub> =1.5W | -                       | 0.05                    | -        | % |
|  |                                       |  | R <sub>L</sub> =8Ω<br>P <sub>O</sub> =0.9W | -                       | 0.035                   | -        |   |
| PSRR   | Power Supply Rejection Ratio          | C <sub>b</sub> =0.22μF, R <sub>L</sub> =8Ω, V <sub>RR</sub> =0.2V <sub>PP</sub> , f <sub>in</sub> =217Hz | -  | 80                      | -                       | dB       |   |
| CMRR   | Common-Mode Rejection Ratio           | C <sub>b</sub> =0.22μF, R <sub>L</sub> =8Ω, V <sub>IC</sub> =0.2V <sub>PP</sub> , f <sub>in</sub> =217Hz | -  | 60                      | -                       | dB       |   |
| S/N  | Signal to Noise Ratio                 | With A-weighted Filter, P <sub>O</sub> =1.3W, R <sub>L</sub> =8Ω   | -  | 105                     | -                       | dB       |   |
| V <sub>OS</sub>                              | Output Offset Voltage                 | R <sub>L</sub> =8Ω   | -  | 5                       | 20                      | mV       |   |
| V <sub>n</sub>                               | Noise Output Voltage                  | C <sub>b</sub> =0.22μF, With A-weighting Filter  | -  | 15                      | -                       | μV (rms) |   |

## Electrical Characteristics (Cont.)

$V_{DD}=5V$ ,  $GND=0V$ ,  $T_A=25^\circ C$  (unless otherwise noted)

| Symbol   | Parameter                                | Test Conditions  | APA0714                       |      |      | Unit             |   |
|--|--|--|-------------------------------|------|------|------------------|---|
|  |  |  | Min.                          | Typ. | Max. |                  |   |
| <b><math>V_{DD}=3.6V</math>, <math>T_A=25^\circ C</math></b> |  |  |                               |      |      |                  |   |
| $P_O$  | Output Power                             | THD+N=1%   | $R_L=3\Omega$                 | -    | 1.2  | -                | W |
|  |  |  | $R_L=4\Omega$                 | -    | 1    | -                |   |
|  |  |  | $R_L=8\Omega$                 | -    | 0.65 | -                |   |
|  |  | THD+N=10%<br>$f_{in}=1kHz$   | $R_L=3\Omega$                 | -    | 1.5  | -                |   |
|  |  |  | $R_L=4\Omega$                 | -    | 1.3  | -                |   |
|  |  |  | $R_L=8\Omega$                 | -    | 0.8  | -                |   |
| THD+N  | Total Harmonic Distortion<br>Pulse Noise | $f_{in}=1kHz$  | $R_L=4\Omega$<br>$P_O=0.7W$   | -    | 0.07 | -                | % |
|  |  |  | $R_L=8\Omega$<br>$P_O=0.45W$  | -    | 0.05 | -                |   |
| PSRR   | Power Supply Rejection Ratio             | $C_b=0.22\mu F$ , $R_L=8\Omega$ , $V_{RR}=0.2V_{PP}$ ,<br>$f_{in}=217Hz$ | -                             | 78   | -    | dB               |   |
| CMRR   | Common-Mode Rejection<br>Ratio           | $C_b=0.22\mu F$ , $R_L=8\Omega$ , $V_{IC}=0.2V_{PP}$ ,<br>$f_{in}=217Hz$ | -                             | 60   | -    |                  |   |
| S/N  | Signal to Noise Ratio                    | With A-weighting Filter,<br>$P_O=0.65W$ , $R_L=8\Omega$                  | -                             | 103  | -    |                  |   |
| $V_{OS}$   | Output Offset Voltage                    | $R_L=8\Omega$  | -                             | 5    | 20   | mV               |   |
| $V_n$  | Noise Output Voltage                     | $C_b=0.22\mu F$ , With A-weighting Filter                                | -                             | 15   | -    | $\mu V$<br>(rms) |   |
| <b><math>V_{DD}=2.4V</math>, <math>T_A=25^\circ C</math></b> |  |  |                               |      |      |                  |   |
| $P_O$  | Output Power                             | THD+N=1%   | $R_L=3\Omega$                 | -    | 0.5  | -                | W |
|  |  |  | $R_L=4\Omega$                 | -    | 0.45 | -                |   |
|  |  |  | $R_L=8\Omega$                 | -    | 0.3  | -                |   |
|  |  | THD+N=10%<br>$f_{in}=1kHz$   | $R_L=3\Omega$                 | -    | 0.7  | -                |   |
|  |  |  | $R_L=4\Omega$                 | -    | 0.6  | -                |   |
|  |  |  | $R_L=8\Omega$                 | -    | 0.35 | -                |   |
| THD+N  | Total Harmonic Distortion<br>Pulse Noise | $f_{in}=1kHz$  | $P_O=0.3W$ ,<br>$R_L=4\Omega$ | -    | 0.1  | -                | % |
|  |  |  | $P_O=0.2W$ ,<br>$R_L=8\Omega$ | -    | 0.08 | -                |   |
| PSRR   | Power Supply Rejection Ratio             | $C_b=0.22\mu F$ , $R_L=8\Omega$ , $V_{RR}=0.2V_{PP}$ ,<br>$f_{in}=217Hz$ | -                             | 75   | -    | dB               |   |
| CMRR   | Common-Mode Rejection<br>Ratio           | $C_b=0.22\mu F$ , $R_L=8\Omega$ , $V_{IC}=0.2V_{PP}$ ,<br>$f_{in}=217Hz$ | -                             | 60   | -    |                  |   |
| S/N  | Signal to Noise Ratio                    | With A-weighting Filter,<br>$P_O=0.3W$ , $R_L=8\Omega$                   | -                             | 100  | -    |                  |   |
| $V_{OS}$   | Output Offset Voltage                    | $R_L=8\Omega$  | -                             | 5    | 20   | mV               |   |
| $V_n$  | Noise Output Voltage                     | $C_b=0.22\mu F$ , With A-weighting Filter                                | -                             | 15   | -    | $\mu V$<br>(rms) |   |

Typical Operating Characteristics

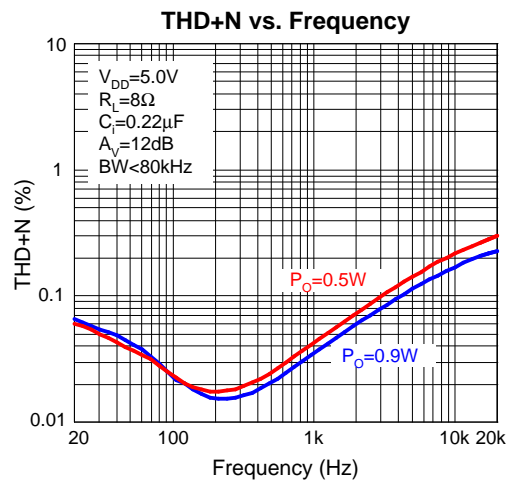
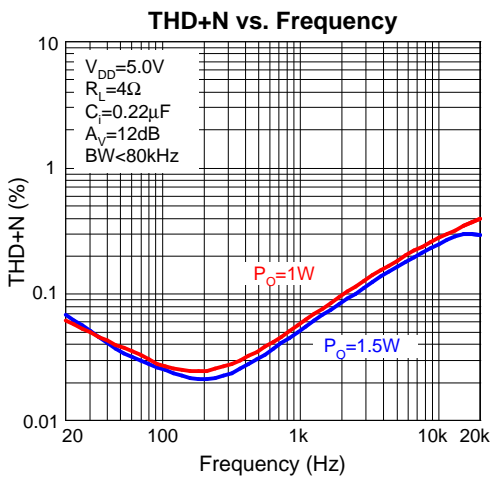
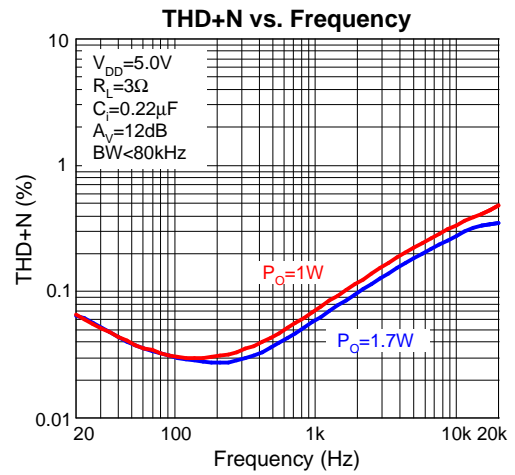
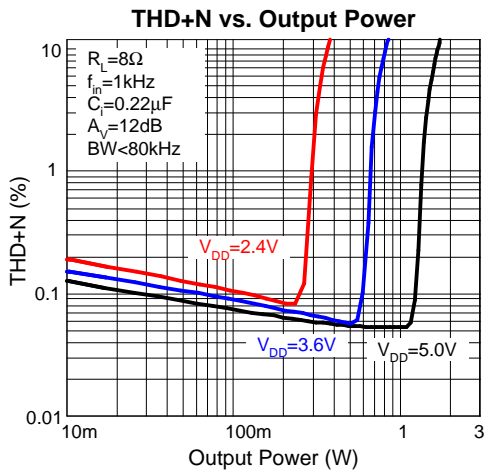
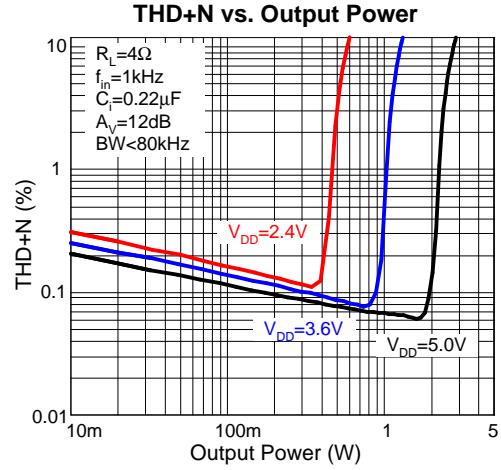
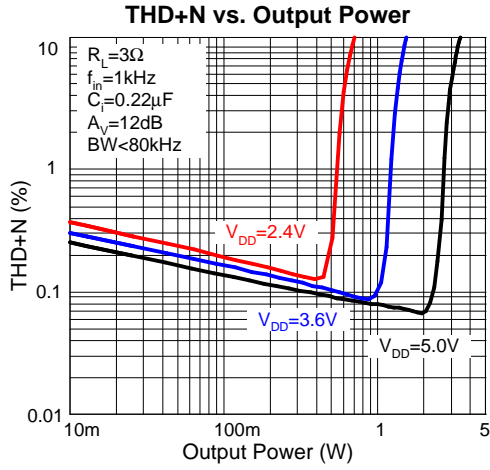

Typical Operating Characteristics (Cont.)

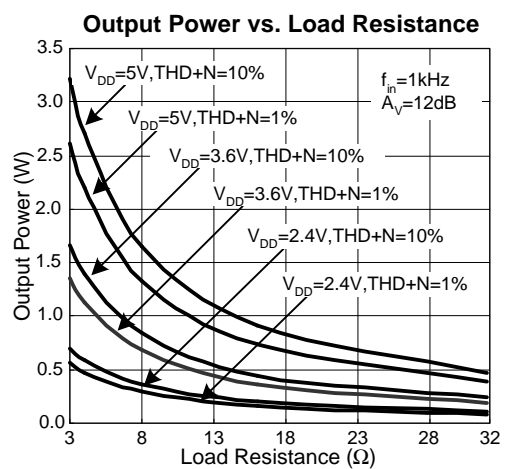
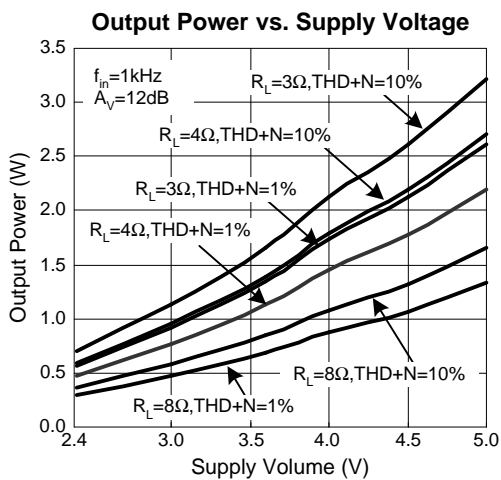
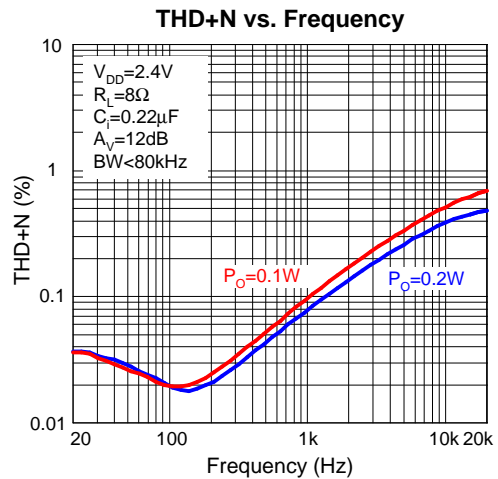
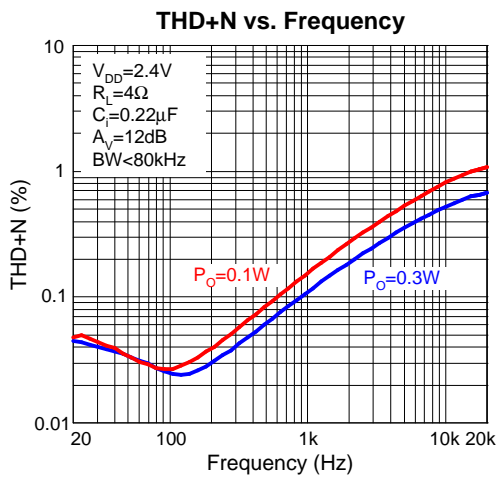
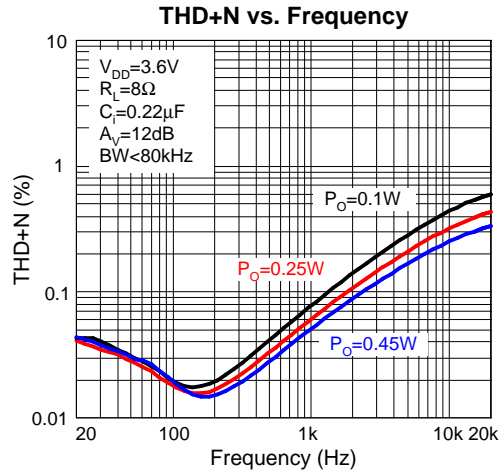
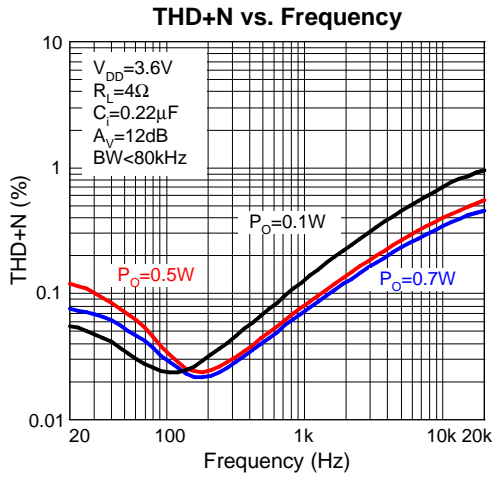

Typical Operating Characteristics (Cont.)

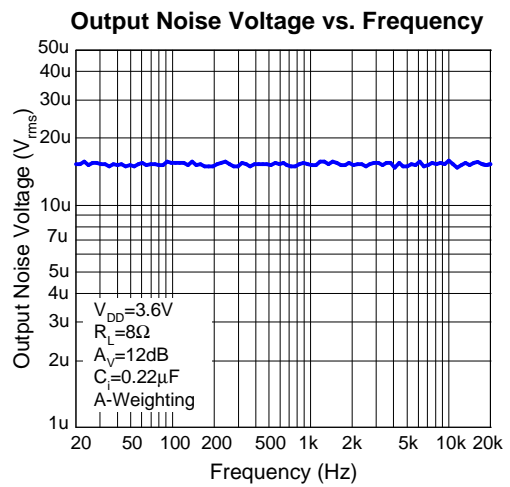
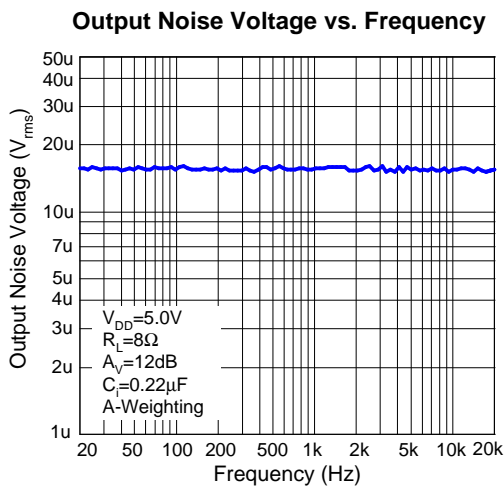
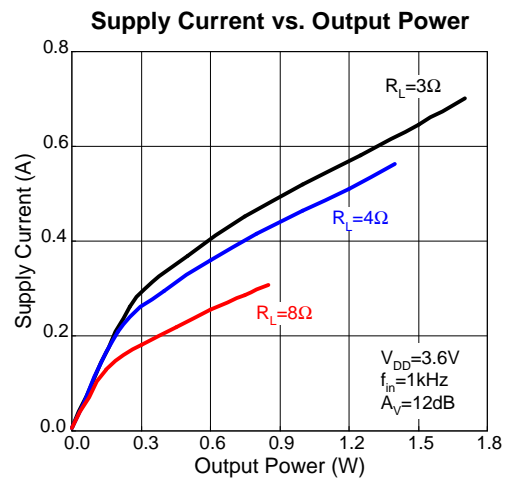
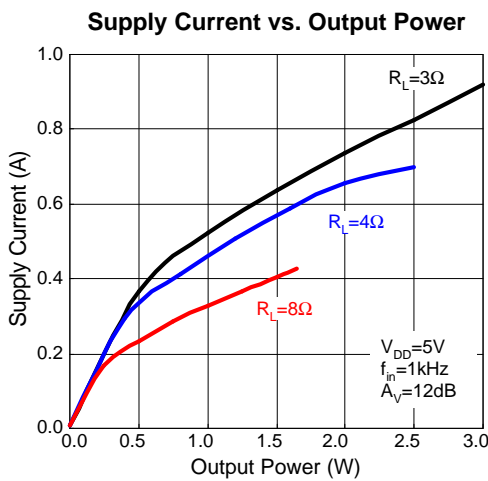
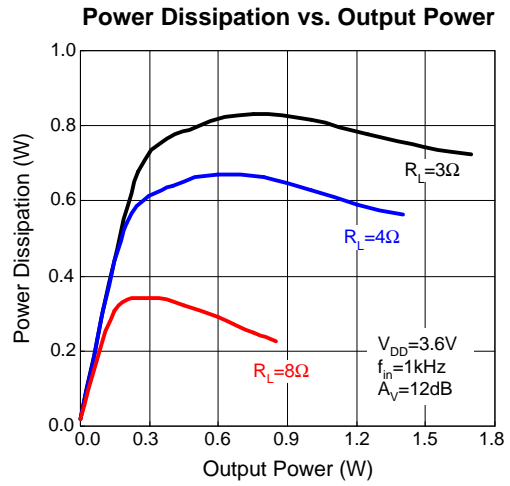
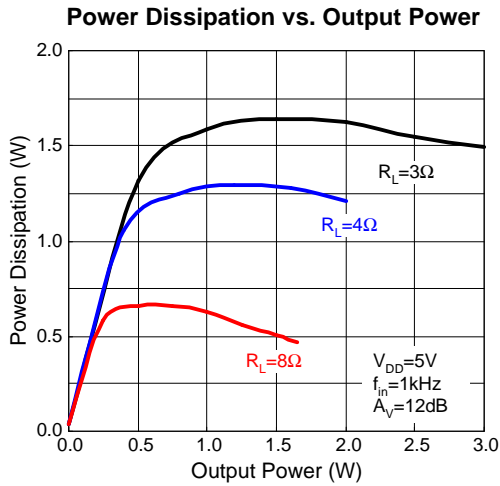

Typical Operating Characteristics (Cont.)

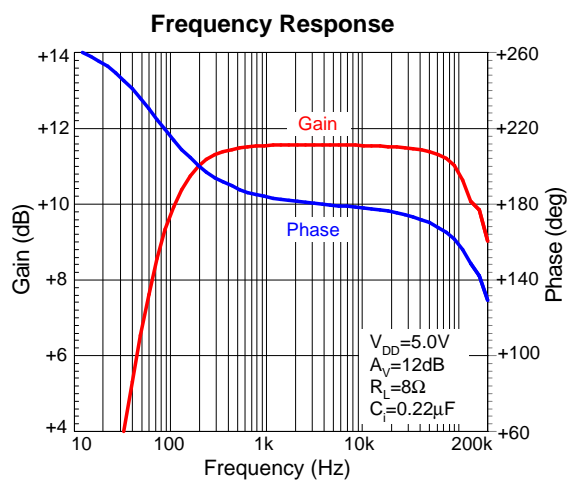
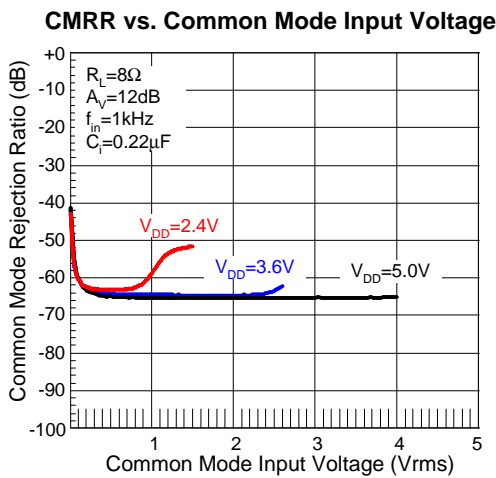
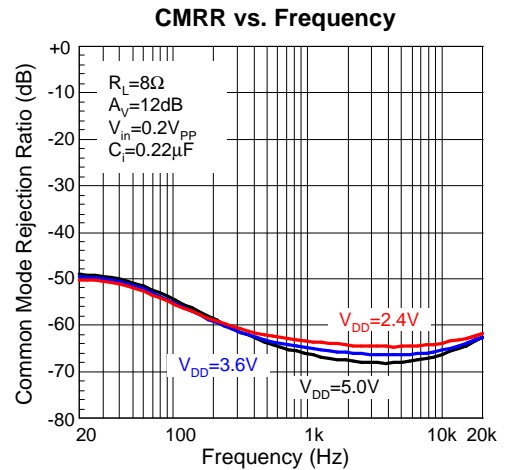
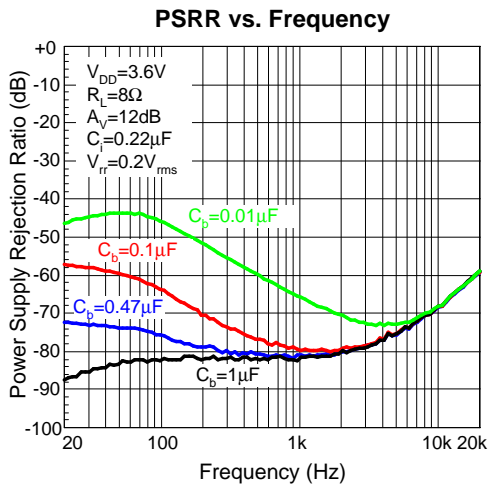
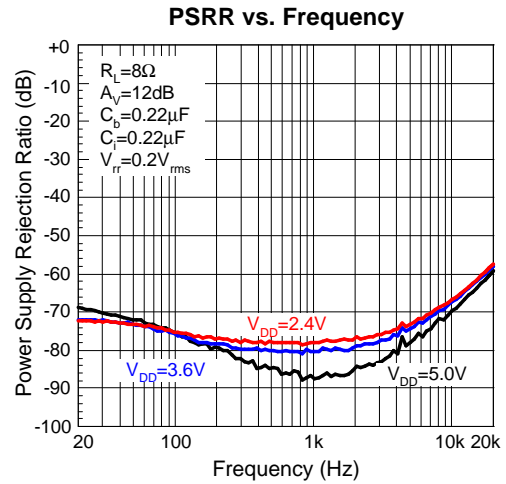
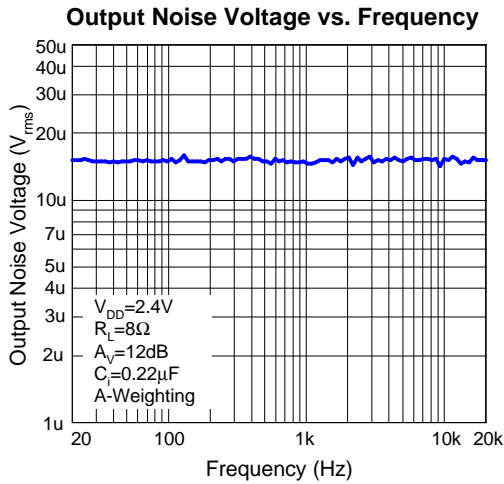



Typical Operating Characteristics (Cont.)

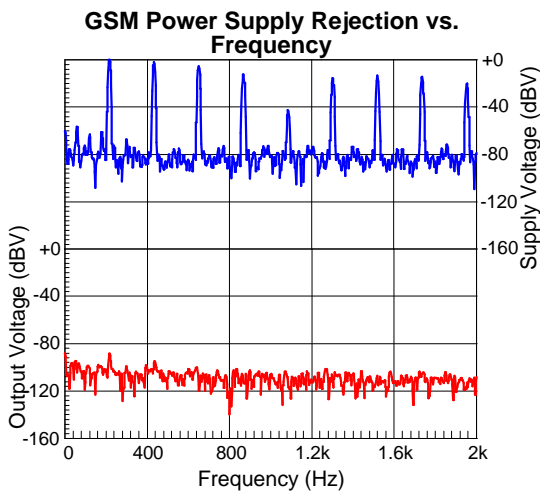
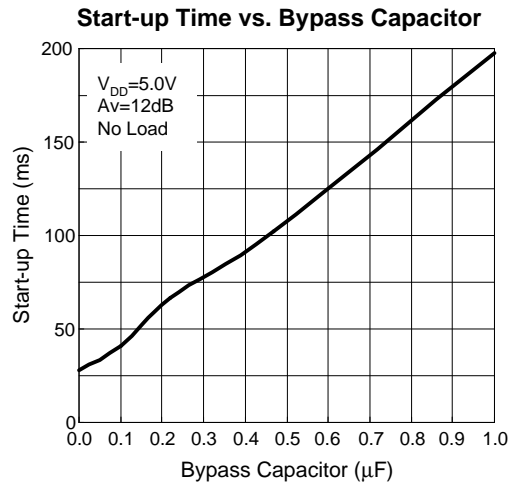
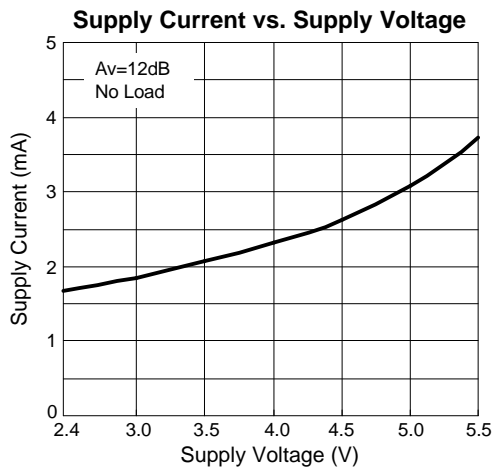
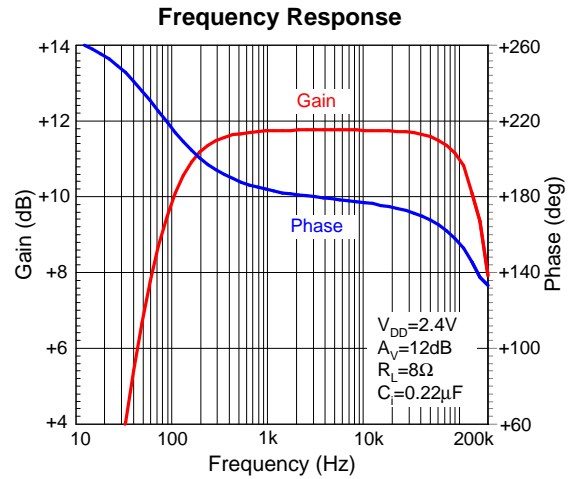
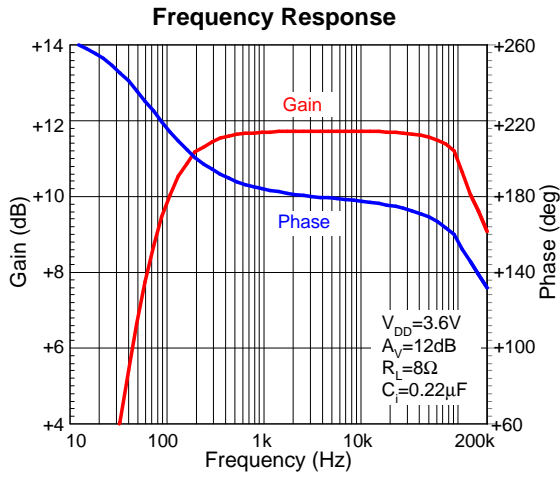

## Operating Waveforms

**GSM Power Supply Rejection vs. Time**

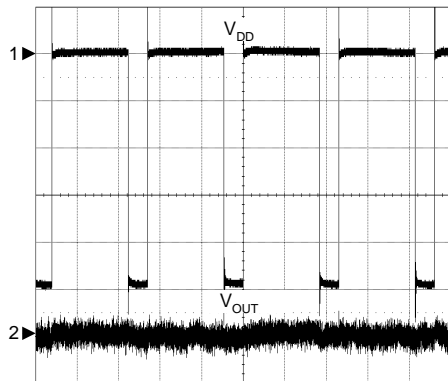

CH1:  $V_{DD}$ , 100mV/Div, DC  
 Voltage Offset = 5.0V  
 CH2:  $V_{OUT}$ , 20mV/Div, DC  
 TIME: 2ms/Div

**Power On**

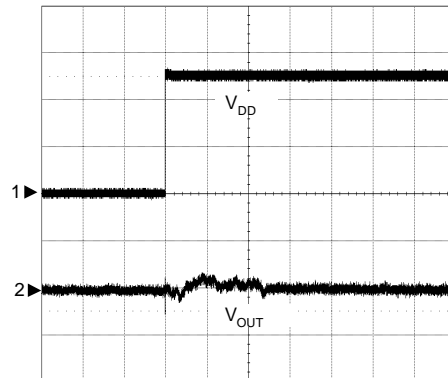

CH1:  $V_{DD}$ , 2V/Div, DC  
 CH2:  $V_{OUT}$ , 50mV/Div, DC  
 TIME: 20ms/Div

**Power Off**

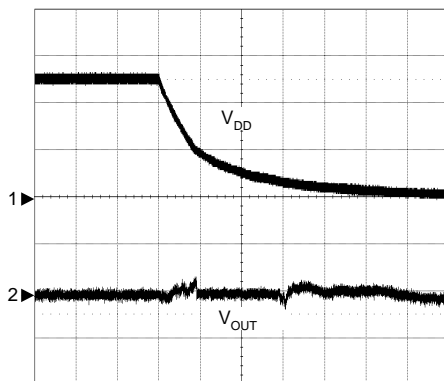

CH1:  $V_{DD}$ , 2V/Div, DC  
 CH2:  $V_{OUT}$ , 50mV/Div, DC  
 TIME: 50ms/Div

**Shutdown Release**

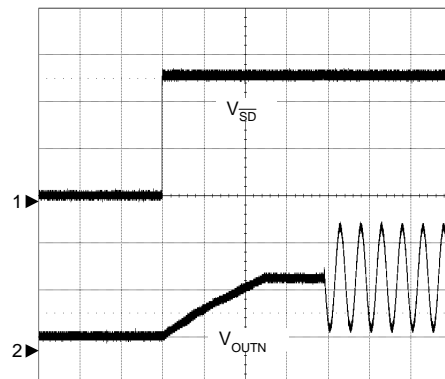

CH1:  $V_{SD}$ , 2V/Div, DC  
 CH2:  $V_{OUTN}$ , 2V/Div, DC  
 TIME: 20ms/Div

## Operating Waveforms (Cont.)

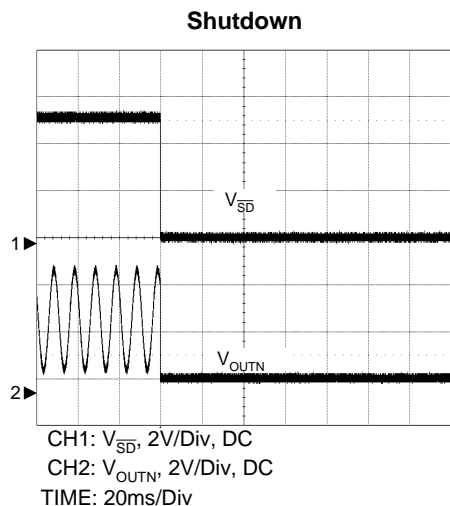

## Pin Description

| PIN |                 | I/O/P | FUNCTION   |
|-----|-----------------|-------|--|
| NO. | NAME            |       |  |
| 1   | $\overline{SD}$ | I     | Shutdown mode control signal input, place left channel speaker amplifier in shutdown mode when held low. |
| 2   | BYPASS          | P     | Bypass voltage input pin   |
| 3   | INP             | I     | The non-inverting input of amplifier. INP is via a capacitor to Gnd for single-end (SE) input signal.    |
| 4   | INN             | I     | The inverting input of amplifier. INN is used as audio input terminal, typically.                        |
| 5   | ROUTP           | O     | The positive output terminal of speaker amplifier.   |
| 6   | VDD             | P     | Supply voltage input pin   |
| 7   | GND             | P     | Ground connection for circuitry.   |
| 8   | LOUTN           | O     | The negative output terminal of speaker amplifier.   |

Block Diagram

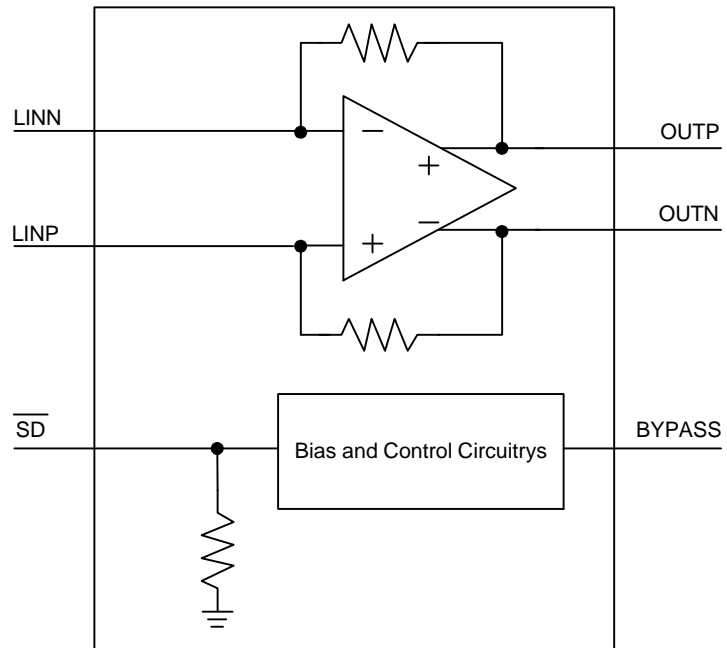

## Typical Application Circuits

Single-ended input mode

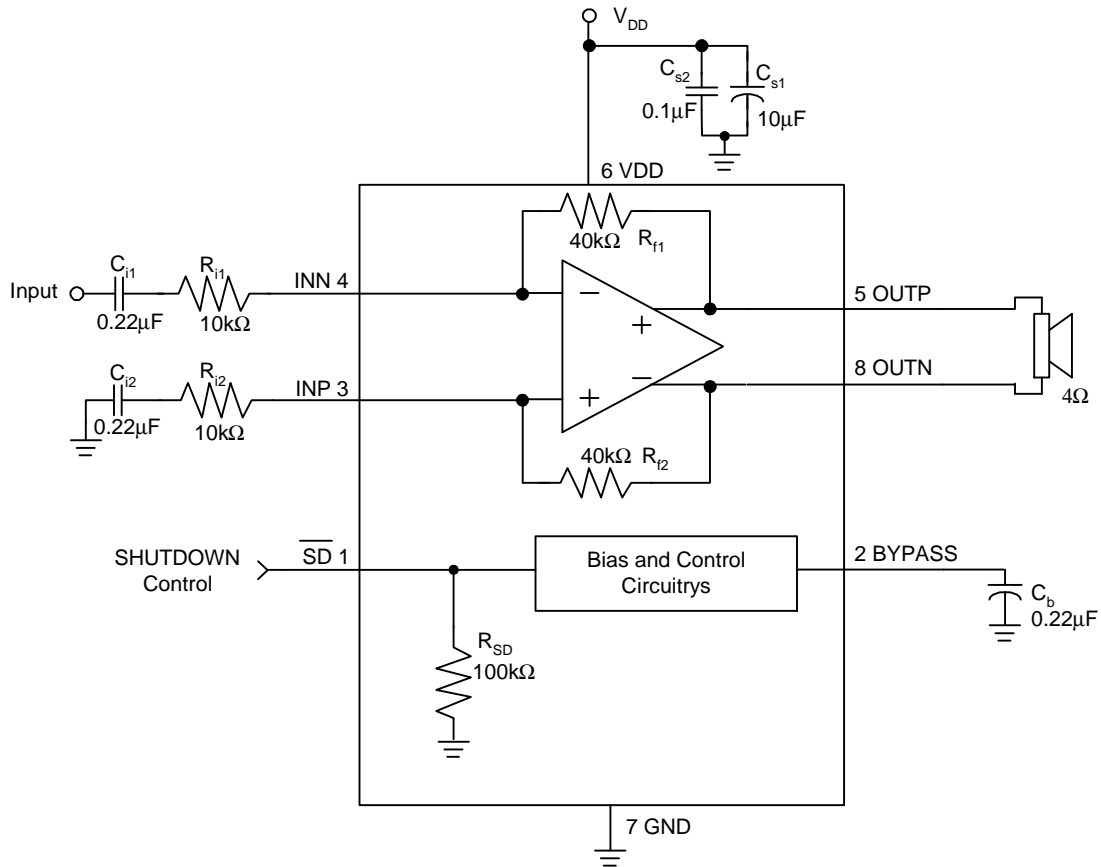

## Typical Application Circuits (Cont.)

### Differential input mode

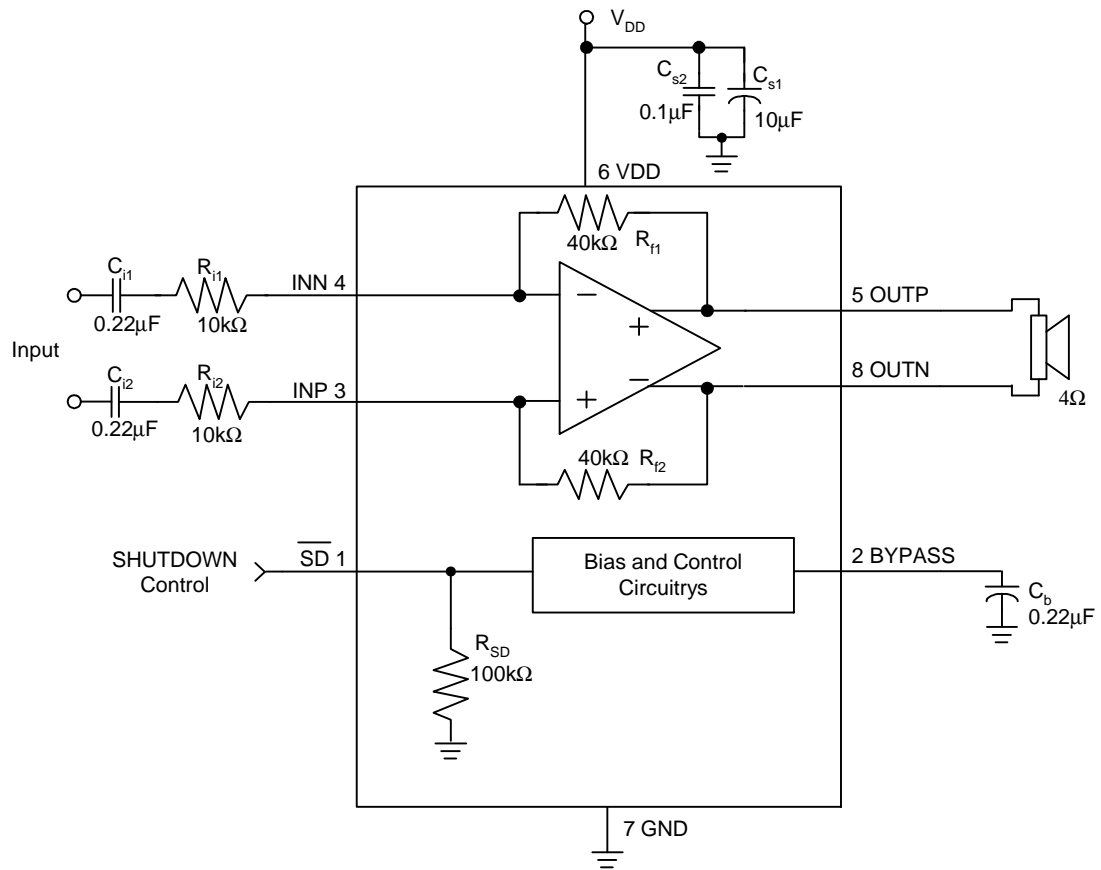

## Function Description

### Fully Differential Amplifier

The power amplifiers are fully differential amplifiers with differential inputs and outputs. The fully differential amplifier has some advantages versus traditional amplifiers. First, don't need the input coupling capacitors because the common-mode feedback compensates the input bias. The inputs can be biased from  $0.5V - V_{DD} - 0.5V$ , and the outputs are still biased at mid-supply of the power amplifier. If the inputs are biased at out of the input range, the coupling capacitors are required. Second, the fully differential amplifier has outstanding immunity against supply voltage ripple (217Hz) caused by the GSM RF transmitters signal which is better than the typical audio amplifier.

### Thermal Protection

The over-temperature circuit limits the junction temperature of the APA0714. When the junction temperature exceeds  $T_j = +150^{\circ}C$ , a thermal sensor turns off the amplifiers, allowing the device to cool. The thermal sensor allows the amplifiers to start-up after the junction temperature cools down to about  $125^{\circ}C$ . The thermal protection is designed with a  $25^{\circ}C$  hysteresis to lower the average  $T_j$  during continuous thermal overload conditions, increasing lifetime of the IC.

### Over-Current Protection

The APA0714 monitors the output buffers current. When the over current occurs, the output buffers current will be reduced and limited to a fold-back current level.

The power amplifier will go back to normal operation until the over-current current situation has been removed. In addition, if the over-current period is long enough and the IC's junction temperature reaches the thermal protection threshold, the IC enters thermal protection mode.

### Shutdown Function

In order to reduce power consumption while not in use, the APA0714 contains a shutdown function to externally turn off the amplifier bias circuitry. This shutdown feature turns the amplifier off when logic low is placed on the SD pin for APA0714. The trigger point between a logic high and logic low level is typically 1.8V. It is best to switch between ground and the supply voltage VDD to provide

maximum device performance. By switching the SD pin to low level, the amplifier enters a low-consumption-current state,  $I_{DD}$  for APA0714 is in shutdown mode. Under normal operating, APA0714's SD pin should pull to high level to keep the IC out of the shutdown mode. The SD pin should be tied to a definite voltage to avoid unwanted state change.

## Application Information

### Input Resistance ( $R_i$ )

The gain for the APA0714 is set by the external input resistors ( $R_i$ ) and internal feedback resistors ( $R_f$ ).

$$A_v = \frac{R_f}{R_i} \quad (1)$$

The internal feedback resistors are 40k $\Omega$  typical. For the performance of a fully differential amplifier, it's better to select matching input resistors  $R_{i1}$  and  $R_{i2}$ . Therefore, 1% tolerance resistors are recommended. If the input resistors are not matched, the CMRR and PSRR performance are worse than using matching devices.

### Input Capacitor ( $C_i$ )

When the APA0714 is driven by a differential input source, the input capacitor may not be required.

In the single-ended input application, an input capacitor,  $C_i$ , is required to allow the amplifier to bias the input signal to the proper DC level for optimum operation. In this case,  $C_i$  and the input resistance  $R_i$  form a high-pass filter with the corner frequency determined in the following equation:

$$F_{C(\text{highpass})} = \frac{1}{2\pi R_i C_i} \quad (2)$$

The value of  $C_i$  must be considered carefully because it directly affects the low frequency performance of the circuit. Consider the example where  $R_i$  is 10k $\Omega$  and the specification that calls for a flat bass response down to 100Hz. The equation is reconfigured below:

$$C_i = \frac{1}{2\pi R_i F_c} \quad (3)$$

When the input resistance variation is considered, the  $C_i$  is 0.16 $\mu$ F. So a value in the range of 0.22 $\mu$ F to 0.47 $\mu$ F would be chosen. A further consideration for this capacitor is the leakage path from the input source through the input network ( $R_i + R_f, C_i$ ) to the load.

This leakage current creates a DC offset voltage at the input of the amplifier. The offset reduces useful headroom, especially in high gain applications. For this reason, a low-leakage tantalum or ceramic capacitor is the best choice. When polarized capacitors are used, the positive side of the capacitor should face the amplifier input in most applications because the DC level of the

amplifiers' inputs are held at  $V_{DD}/2$ . Please note that it is important to confirm the capacitor polarity in the application.

### Effective Bypass Capacitor ( $C_{\text{BYPASS}}$ )

The BYPASS pin sets the  $V_{DD}/2$  for internal reference by voltage divider. Adding capacitors at this pin to filter the noise and regulator the mid-supply rail will increase the PSRR and noise performance.

The capacitors should be as close to the device as possible. The effect of a larger bypass capacitor will improve PSRR due to increased supply stability.

The bypass capacitance also affects to the start time. The large capacitors will increase the start time when device in shutdown.

### Optimizing Depop Circuitry

Circuitry has been included in the APA0714 to minimize the amount of popping noise at power-up and when coming out of shutdown mode. Popping occurs whenever a voltage step is applied to the speaker. In order to eliminate clicks and pops, all capacitors must be fully discharged before turn-on. Rapid on/off switching of the device or the shutdown function will cause the click and pop circuitry.

The value of  $C_i$  will also affect turn-on pops. The bypass voltage ramp up should be slower than input bias voltage. Although the BYPASS pin current source cannot be modified, the size of  $C_{\text{BYPASS}}$  can be changed to alter the device turn-on time and the amount of clicks and pops. By increasing the value of  $C_{\text{BYPASS}}$ , turn-on pop can be reduced. However, the tradeoff for using a larger bypass capacitor is to increase the turn-on time for this device. There is a linear relationship between the size of  $C_{\text{BYPASS}}$  and the turn-on time.

A high gain amplifier intensifies the problem as the small delta in voltage is multiplied by the gain. Hence, it is advantageous to use low-gain configurations.

### Power Supply Decoupling Capacitor ( $C_s$ )

The APA0714 is a high-performance CMOS audio amplifier that requires adequate power supply decoupling to ensure the output total harmonic distortion (THD+N) is as low as possible. Power supply decoupling also pre-



## Application Information (Cont.)

### Power Supply Decoupling Capacitor (C<sub>s</sub>) (Cont.)

vents the oscillations caused by long lead length between the amplifier and the speaker.

The optimum decoupling is achieved by using two different types of capacitors that target on different types of noises on the power supply leads. For higher frequency transients, spikes, or digital hash on the line, a good low equivalent-series-resistance (ESR) ceramic capacitor, typically 0.1μF, is placed as close as possible to the device VDD lead works best. For filtering lower frequency noise signals, a large aluminum electrolytic capacitor of 10μF or greater placed near the audio power amplifier is recommended.

### Fully Differential Amplifier Efficiency

The traditional class AB power amplifier efficiency can be calculated starts out as being equal to the ratio of power from the power supply to the power delivered to the load. The following equations are the basis for calculating the amplifier efficiency.

$$\text{Efficiency } (\eta) = \frac{P_o}{P_{SUP}} \quad (4)$$

where:

$$P_o = \frac{V_{Orms}^2}{R_L} = \frac{V_P^2}{2R_L}$$

$$V_{Orms} = \frac{V_P}{\sqrt{2}}$$

$$P_{SUP} = V_{DD} \times I_{DD(AVG)} = \frac{2V_{DD}V_{PP}}{\pi R_L} \quad (5)$$

$$I_{DD(AVG)} = \frac{2V_P}{\pi R_L}$$

So the Efficiency (η) is:

$$\text{Efficiency } (\eta) = \frac{\pi V_P}{4V_{DD}} = \frac{\pi \sqrt{2P_o R_L}}{4V_{DD}} \quad (6)$$

Table 1 calculates efficiencies for four different output power levels. Note that the efficiency of the amplifier is quite low for lower power levels and rises sharply as power to the load is increased resulting in nearly flat internal power dissipation over the normal operating range. Note that the internal dissipation at full output power is

less than the dissipation in the half power range. Calculating the efficiency for a specific system is the key to proper power supply design. For a Mono 1W audio system with 8Ω loads and a 5V supply, the maximum draw on the power supply is almost 1.63W.

Table 1: Efficiency vs. Output Power in 5-V Differential Amplifier Systems

| R <sub>L</sub> (W) | P <sub>o</sub> (W) | Efficiency (%) | I <sub>DD</sub> (A) | P <sub>D</sub> (W) | P <sub>SUP</sub> (W) |
|--------------------|--------------------|----------------|---------------------|--------------------|----------------------|
| 8                  | 0.25               | 30.1           | 0.17                | 0.58               | 0.83                 |
|                    | 0.50               | 43.1           | 0.23                | 0.66               | 1.16                 |
|                    | 1                  | 61.5           | 0.33                | 0.63               | 1.63                 |
|                    | 1.6                | 77.7           | 0.43                | 0.46               | 2.06                 |
| 4                  | 0.4                | 27.5           | 0.29                | 1.06               | 1.46                 |
|                    | 1.2                | 48.1           | 0.51                | 1.30               | 2.50                 |
|                    | 2                  | 62.4           | 0.66                | 1.21               | 3.21                 |
|                    | 2.6                | 74.1           | 0.70                | 0.91               | 3.51                 |
| 3                  | 0.5                | 27.5           | 0.37                | 1.32               | 1.82                 |
|                    | 1                  | 38.7           | 0.52                | 1.58               | 2.58                 |
|                    | 2                  | 55.1           | 0.74                | 1.63               | 3.63                 |
|                    | 3                  | 66.8           | 0.92                | 1.49               | 4.49                 |

A final point to remember about linear amplifiers (either SE or Differential) is how to manipulate the terms in the efficiency equation to an utmost advantage when possible. Note that in equation, V<sub>DD</sub> is in the denominator. This indicates that as V<sub>DD</sub> goes down, efficiency goes up. In other words, use the efficiency analysis to choose the correct supply voltage and speaker impedance for the application.

### Layout Recommendation

1. All components should be placed close to the APA0714. For example, the input capacitor (C<sub>i</sub>) should be close to APA0714's input pins to avoid causing noise coupling to APA0714's high impedance inputs; the decoupling capacitor (C<sub>s</sub>) should be placed by the APA0714's power pin to decouple the power rail noise.
2. The output traces should be short, wide (>50mil), and symmetric.
3. The input trace should be short and symmetric.
4. The power trace width should greater than 50mil.
5. The MSOP-8P and DFN3x3-8 Thermal PAD should be soldered on PCB, and the ground plane needs soldered mask (to avoid short circuit) except the Thermal PAD area.

## Application Information (Cont.)

### Layout Recommendation (Cont.)

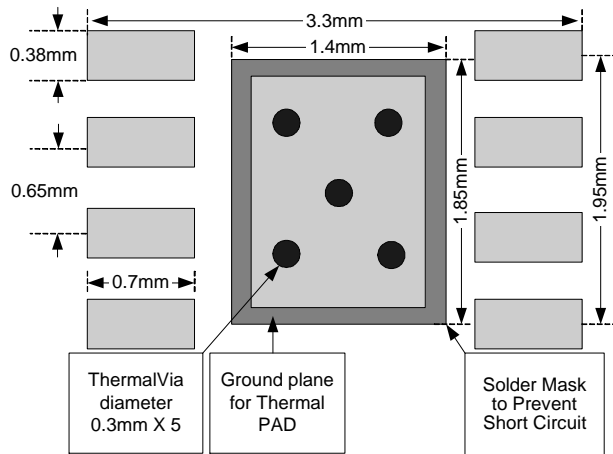
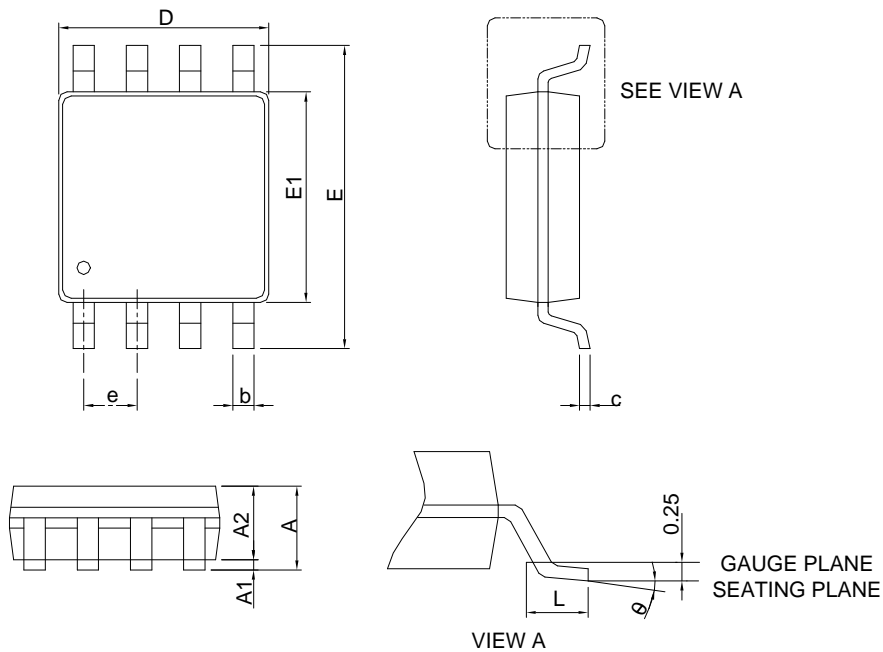

Figure 1: TDFN3X3-8 Land Pattern Recommendation

## Package Information

### MSOP-8



| DIMENSIONS | MSOP-8      |      |           |       |
|------------|-------------|------|-----------|-------|
|            | MILLIMETERS |      | INCHES    |       |
|            | MIN.        | MAX. | MIN.      | MAX.  |
| A          |             | 1.10 |           | 0.043 |
| A1         | 0.00        | 0.15 | 0.000     | 0.006 |
| A2         | 0.75        | 0.95 | 0.030     | 0.037 |
| b          | 0.22        | 0.38 | 0.009     | 0.015 |
| c          | 0.08        | 0.23 | 0.003     | 0.009 |
| D          | 2.90        | 3.10 | 0.114     | 0.122 |
| E          | 4.70        | 5.10 | 0.185     | 0.201 |
| E1         | 2.90        | 3.10 | 0.114     | 0.122 |
| e          | 0.65 BSC    |      | 0.026 BSC |       |
| L          | 0.40        | 0.80 | 0.016     | 0.031 |
| θ          | 0°          | 8°   | 0°        | 8°    |

- Note: 1. Follow JEDEC MO-187 AA.  
 2. Dimension " D " does not include mold flash, protrusions or gate burrs. Mold flash, protrusion or gate burrs shall not exceed 6 mil per side.  
 3. Dimension " E1 " does not include inter-lead flash or protrusions. Inter-lead flash and protrusions shall not exceed 5 mil per side.

Package Information (Cont.)

MSOP-8P

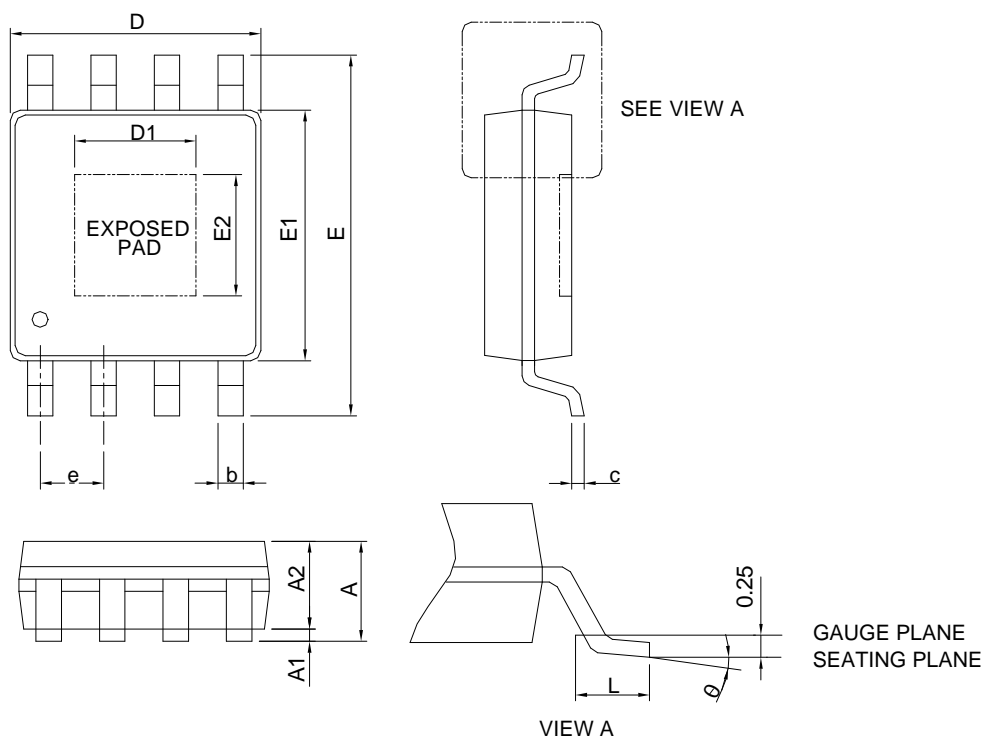

| SYMBOL | MSOP-8P     |      |           |       |
|--------|-------------|------|-----------|-------|
|        | MILLIMETERS |      | INCHES    |       |
|        | MIN.        | MAX. | MIN.      | MAX.  |
| A      |             | 1.10 |           | 0.043 |
| A1     | 0.00        | 0.15 | 0.000     | 0.006 |
| A2     | 0.75        | 0.95 | 0.030     | 0.037 |
| b      | 0.22        | 0.38 | 0.009     | 0.015 |
| c      | 0.08        | 0.23 | 0.003     | 0.009 |
| D      | 2.90        | 3.10 | 0.114     | 0.122 |
| D1     | 1.50        | 2.50 | 0.059     | 0.098 |
| E      | 4.70        | 5.10 | 0.185     | 0.201 |
| E1     | 2.90        | 3.10 | 0.114     | 0.122 |
| E2     | 1.50        | 2.50 | 0.059     | 0.098 |
| e      | 0.65 BSC    |      | 0.026 BSC |       |
| L      | 0.40        | 0.80 | 0.016     | 0.031 |
| θ      | 0°          | 8°   | 0°        | 8°    |

- Note: 1. Follow JEDEC MO-187 AA-T  
 2. Dimension " D " does not include mold flash, protrusions or gate burrs. Mold flash, protrusion or gate burrs shall not exceed 6 mil per side.  
 3. Dimension " E1 " does not include inter-lead flash or protrusions. Inter-lead flash and protrusions shall not exceed 6 mil per side.

Package Information (Cont.)

TDFN3x3-8

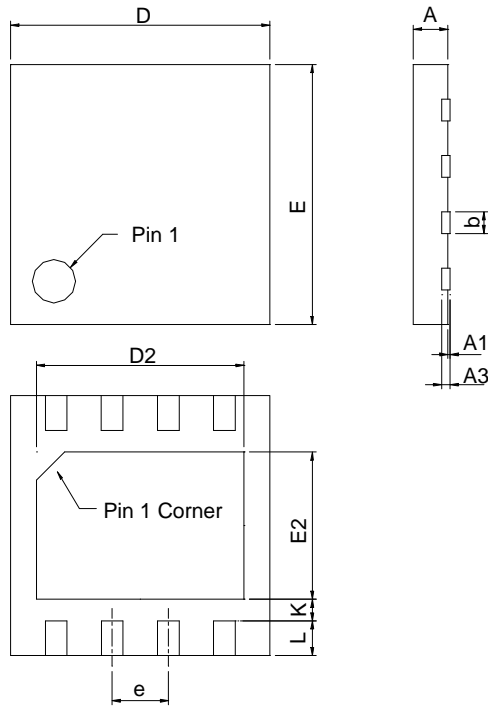

| SYMBOL | TDFN3x3-8   |      |           |       |
|--------|-------------|------|-----------|-------|
|        | MILLIMETERS |      | INCHES    |       |
|        | MIN.        | MAX. | MIN.      | MAX.  |
| A      | 0.70        | 0.80 | 0.028     | 0.031 |
| A1     | 0.00        | 0.05 | 0.000     | 0.002 |
| A3     | 0.20 REF    |      | 0.008 REF |       |
| b      | 0.25        | 0.35 | 0.010     | 0.014 |
| D      | 2.90        | 3.10 | 0.114     | 0.122 |
| D2     | 1.90        | 2.40 | 0.075     | 0.094 |
| E      | 2.90        | 3.10 | 0.114     | 0.122 |
| E2     | 1.40        | 1.75 | 0.055     | 0.069 |
| e      | 0.65 BSC    |      | 0.026 BSC |       |
| L      | 0.30        | 0.50 | 0.012     | 0.020 |
| K      | 0.20        |      | 0.008     |       |

### Carrier Tape & Reel Dimensions

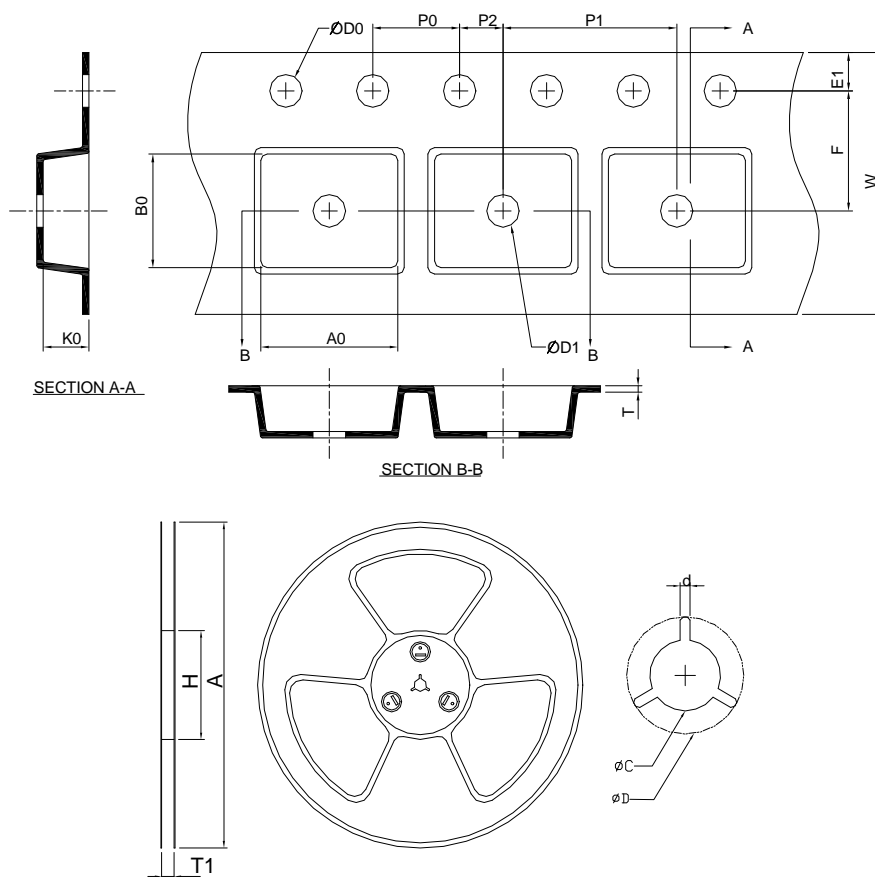

| Application | A           | H          | T1                 | C                  | d        | D                 | W          | E1         | F          |
|-------------|-------------|------------|--------------------|--------------------|----------|-------------------|------------|------------|------------|
| MSOP-8      | 330.0 ±2.00 | 50 MIN.    | 12.4+2.00<br>-0.00 | 13.0+0.50<br>-0.20 | 1.5 MIN. | 20.2 MIN.         | 12.0 ±0.30 | 1.75 ±0.10 | 5.5 ±0.05  |
|             | P0          | P1         | P2                 | D0                 | D1       | T                 | A0         | B0         | K0         |
|             | 4.00 ±0.10  | 8.00 ±0.10 | 2.00 ±0.05         | 1.5+0.10<br>-0.00  | 1.5 MIN. | 0.6+0.00<br>-0.40 | 5.30 ±0.20 | 3.30 ±0.20 | 1.40 ±0.20 |
| Application | A           | H          | T1                 | C                  | d        | D                 | W          | E1         | F          |
| MSOP-8P     | 330.0 ±2.00 | 50 MIN.    | 12.4+2.00<br>-0.00 | 13.0+0.50<br>-0.20 | 1.5 MIN. | 20.2 MIN.         | 12.0 ±0.30 | 1.75 ±0.10 | 5.5 ±0.05  |
|             | P0          | P1         | P2                 | D0                 | D1       | T                 | A0         | B0         | K0         |
|             | 4.00 ±0.10  | 8.00 ±0.10 | 2.00 ±0.05         | 1.5+0.10<br>-0.00  | 1.5 MIN. | 0.6+0.00<br>-0.40 | 5.30 ±0.20 | 3.30 ±0.20 | 1.40 ±0.20 |
| Application | A           | H          | T1                 | C                  | d        | D                 | W          | E1         | F          |
| TDFN3x3-8   | 178.0 ±2.00 | 50 MIN.    | 12.4+2.00<br>-0.00 | 13.0+0.50<br>-0.20 | 1.5 MIN. | 20.2 MIN.         | 12.0 ±0.30 | 1.75 ±0.10 | 5.5 ±0.05  |
|             | P0          | P1         | P2                 | D0                 | D1       | T                 | A0         | B0         | K0         |
|             | 4.0 ±0.10   | 8.0 ±0.10  | 2.0 ±0.05          | 1.5+0.10<br>-0.00  | 1.5 MIN. | 0.6+0.00<br>-0.40 | 3.30 ±0.20 | 3.30 ±0.20 | 1.30 ±0.20 |

(mm)

**Devices Per Unit**

| Package Type | Unit        | Quantity |
|--------------|-------------|----------|
| MOSP-8       | Tape & Reel | 3000     |
| MOSP-8P      | Tape & Reel | 3000     |
| TDFN3x3-8    | Tape & Reel | 3000     |

**Taping Dircetion Information**

MSOP-8(P)

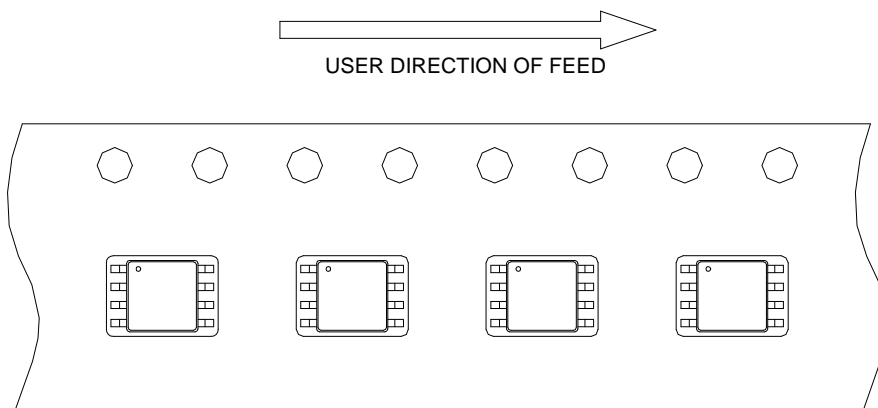

TDFN3x3-8

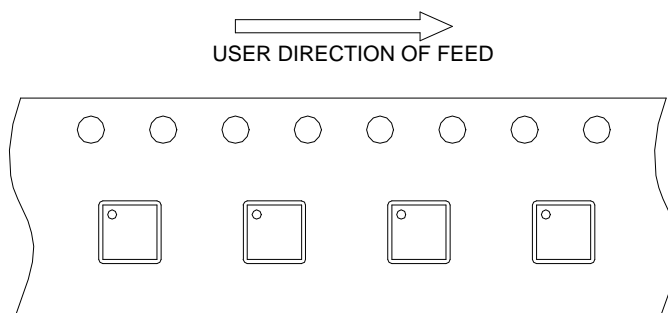

**Classification Profile**

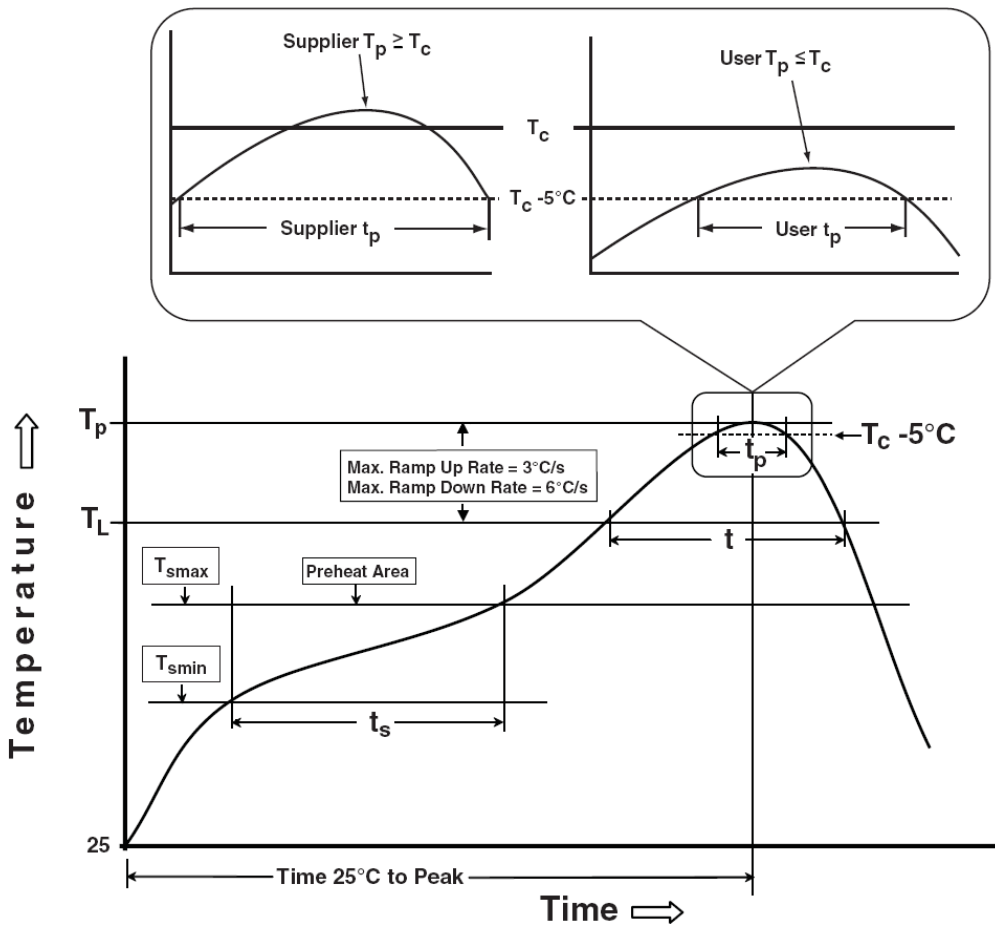

**Classification Reflow Profiles**

| Profile Feature   | Sn-Pb Eutectic Assembly            | Pb-Free Assembly                   |
|---|------------------------------------|------------------------------------|
| <b>Preheat &amp; Soak</b>   |                                    |                                    |
| Temperature min ( $T_{smin}$ )  | 100 °C                             | 150 °C                             |
| Temperature max ( $T_{smax}$ )  | 150 °C                             | 200 °C                             |
| Time ( $T_{smin}$ to $T_{smax}$ ) ( $t_s$ )                                       | 60-120 seconds                     | 60-120 seconds                     |
| Average ramp-up rate ( $T_{smax}$ to $T_p$ )                                      | 3 °C/second max.                   | 3°C/second max.                    |
| Liquidous temperature ( $T_L$ )   | 183 °C                             | 217 °C                             |
| Time at liquidous ( $t_l$ )   | 60-150 seconds                     | 60-150 seconds                     |
| Peak package body Temperature ( $T_p$ )*  | See Classification Temp in table 1 | See Classification Temp in table 2 |
| Time ( $t_p$ )** within 5°C of the specified classification temperature ( $T_c$ ) | 20** seconds                       | 30** seconds                       |
| Average ramp-down rate ( $T_p$ to $T_{smax}$ )                                    | 6 °C/second max.                   | 6 °C/second max.                   |
| Time 25°C to peak temperature   | 6 minutes max.                     | 8 minutes max.                     |

\* Tolerance for peak profile Temperature ( $T_p$ ) is defined as a supplier minimum and a user maximum.

\*\* Tolerance for time at peak profile temperature ( $t_p$ ) is defined as a supplier minimum and a user maximum.



## Classification Reflow Profiles (Cont.)

Table 1. SnPb Eutectic Process – Classification Temperatures (Tc)

| Package Thickness | Volume mm <sup>3</sup><br><350 | Volume mm <sup>3</sup><br>≥350 |
|-------------------|--------------------------------|--------------------------------|
| <2.5 mm           | 235 °C                         | 220 °C                         |
| ≥2.5 mm           | 220 °C                         | 220 °C                         |

Table 2. Pb-free Process – Classification Temperatures (Tc)

| Package Thickness | Volume mm <sup>3</sup><br><350 | Volume mm <sup>3</sup><br>350-2000 | Volume mm <sup>3</sup><br>>2000 |
|-------------------|--------------------------------|------------------------------------|---------------------------------|
| <1.6 mm           | 260 °C                         | 260 °C                             | 260 °C                          |
| 1.6 mm – 2.5 mm   | 260 °C                         | 250 °C                             | 245 °C                          |
| ≥2.5 mm           | 250 °C                         | 245 °C                             | 245 °C                          |

## Reliability Test Program

| Test item     | Method             | Description                            |
|---------------|--------------------|--|
| SOLDERABILITY | JESD-22, B102      | 5 Sec, 245°C                           |
| HOLT          | JESD-22, A108      | 1000 Hrs, Bias @ T <sub>p</sub> =125°C |
| PCT           | JESD-22, A102      | 168 Hrs, 100%RH, 2atm, 121°C           |
| TCT           | JESD-22, A104      | 500 Cycles, -65°C~150°C                |
| HBM           | MIL-STD-883-3015.7 | VHBM 2KV                               |
| MM            | JESD-22, A115      | VMM 200V                               |
| Latch-Up      | JESD 78            | 10ms, 1 <sub>tr</sub> 100mA            |

## Customer Service

### Anpec Electronics Corp.

Head Office :

No.6, Dusing 1st Road, SBIP,  
Hsin-Chu, Taiwan  
Tel : 886-3-5642000  
Fax : 886-3-5642050

Taipei Branch :

2F, No. 11, Lane 218, Sec 2 Jhongsing Rd.,  
Sindian City, Taipei County 23146, Taiwan  
Tel : 886-2-2910-3838  
Fax : 886-2-2917-3838