



M.S.KENNEDY CORP.

6W
DC-DC
CONVERTERS

DAC2800S
SERIES

4707 Dey Road Liverpool, N.Y. 13088

(315) 701-6751

HI-REL DESIGN

- WAVE SOLDERABLE PACKAGE
- ALL CERAMIC CAPACITORS
- SURFACE MOUNT MAGNETICS

FEATURES

- REPLACES APEX DHC2812S, DHC2815S
- NO DERATING — -55°C TO +125°C
- HIGH ISOLATION — 500V
- OUTPUT VOLTAGE ADJUSTMENT STANDARD
- REMOTE SHUTDOWN
- 11 – 50V INPUT @ 5 WATTS OUTPUT

DESCRIPTION

The DAC2812S and DAC2815S DC-DC converters are higher output voltage companion devices to MSK's DHC types. The DAC's provide the ruggedness, reliability and features required to meet the advanced design challenges of today's hi-rel market. This has been accomplished while retaining a power density of 15 W/in³ and 375 mW/gram of power/package performance. The use of advanced substrate and reflow soldering techniques during construction results in a rugged, cost-effective and completely solderable package.

The DAC2800S hybrid converter series utilizes all ceramic capacitors, surface mount magnetics, and ultrasonically bonded wires to provide reliable operation at all operating temperatures while surviving G forces of up to 500 G.

The DAC2800S series standard features include output fault monitoring and/or turn on voltage point programming via the shutdown pin. All three functions may be implemented simultaneously with a minimum of external components. An output voltage adjustment / load compensation pin which adjusts outputs simultaneously is also standard.

Fault tolerant design protects these converters from most external circuit faults. The +output and output adjust pins will withstand +25 V while the shutdown pin will withstand +50 V, protecting the converters from a variety of system or board faults; e.g. solder bridges etc. Unique load fault protection circuitry allows this converter to pull up loads having difficult static load line characteristics and allows short term load excursions significantly beyond ratings in most applications.

A transformer isolated flyback converter topology operating at a switching frequency of 400 kHz allows operation over a wide input voltage range. Internal filtering of outputs eliminates the need for external capacitors in many applications.

The 8-pin package is hermetically sealed and isolated from the internal circuits. Heat sinking is recommended for full power operation at elevated ambient temperatures.

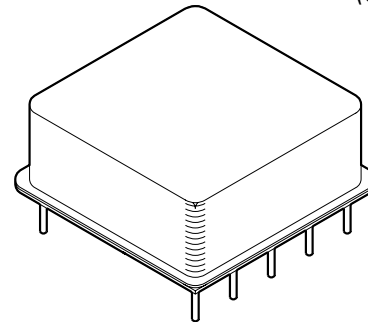

TYPICAL APPLICATION

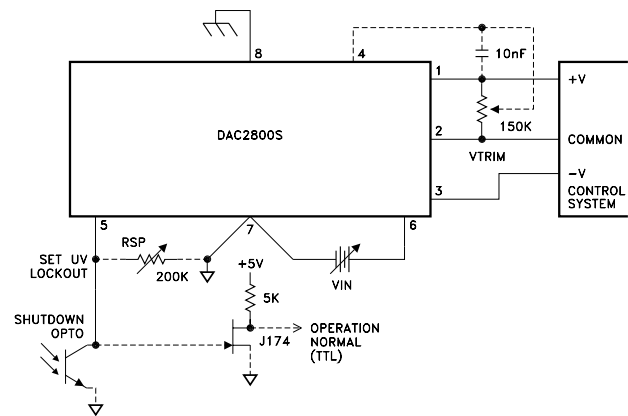

BLOCK DIAGRAM

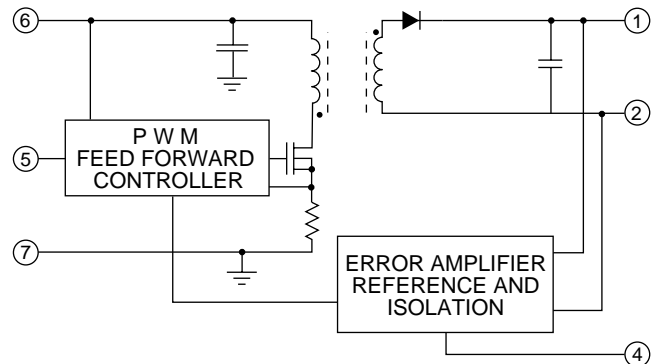

EXTERNAL CONNECTIONS

- | | |
|-----------------|----------|
| 1 +OUTPUT | 8 CASE |
| 2 OUTPUT COMMON | 7 -INPUT |
| 3 N/C | 6 +INPUT |
| 4 ADJUST/COMP | |
| 5 SHUTDOWN PLUS | |

DAC2812S • DAC2815S

ABSOLUTE MAXIMUM RATINGS SPECIFICATIONS

ABSOLUTE MAXIMUM RATINGS	INPUT VOLTAGE RANGE (Pin 7 to 6 or 5)	DAC2812S	DAC2815S
	INPUT TRANSIENT (Pin 7 to 6)	50Vdc	50Vdc
	OUTPUT CURRENT (Continuous)	80V @ 50ms	80V @ 50ms
	TEMPERATURE, Storage	450mA	360mA
	TEMPERATURE, Pin Soldering 10s	-65°C, 150°C	-65°C, 150°C
		300°C	300°C

SPECIFICATIONS

PARAMETER	TEST CONDITIONS ¹	DAC2812S			DAC2815S			UNITS
		MIN	TYP	MAX	MIN	TYP	MAX	
STEADY STATE CHARACTERISTICS								
INPUT VOLTAGE RANGE	-55°C ↔ 125°C	11	28	50	11	28	50	Vdc
OUTPUT VOLTAGE	I _o = 10%	11.9	12	12.1	14.9	15	15.1	Vdc
OUTPUT CURRENT -55°C × 125°C	V _{IN} = 16 ↔ 40			450			360	mAdc
	V _{IN} = 11 ↔ 50			417			333	mAdc
OUTPUT POWER -55°C × 125°C	V _{IN} = 16 ↔ 40			5.4			5.4	W
	V _{IN} = 11 ↔ 50			5			5	W
EFFICIENCY	I _o = 100%	62	67		63	68		%
LINE REGULATION	V _{IN} = 11 ↔ 50 ²		5	25		5	25	mV
LOAD REGULATION	P _o = 0-5.4W ²		5	25		5	25	mV
OPERATING TEMPERATURE, CASE		-55		125	-55		125	°C
TEMPERATURE COEFFICIENT (V _{out})			0.006			0.006		%/°C
INPUT RIPPLE CURRENT	Bandwidth = 10kHz → 1MHz		340	400		340	400	mArms
WITH 1μH SERIES INDUCTANCE	Bandwidth = 10kHz → 1MHz		45	55		45	55	mArms
OUTPUT RIPPLE VOLTAGE	Bandwidth = 10kHz → 1MHz		15	60		15	60	mVrms
LOAD CAPACITANCE (OUTPUT OVER -55°C × 125°C)	V _{IN} = 16 ↔ 40			200			200	μF
	V _{IN} = 11 ↔ 50			100			100	μF
SHORT CIRCUIT DISSIPATION			0.5			0.5		W
QUIESCENT INPUT CURRENT			50	70		50	70	mA
INHIBITED		0.09	1.25	2.5	0.09	1.25	2.5	mA
ISOLATION CHARACTERISTICS (INPUT/OUTPUT/CASE)								
LEAKAGE RESISTANCE	500 Vdc	100			100			MΩ
LEAKAGE CAPACITANCE	10kHz		400		400	500		pF
DYNAMIC CHARACTERISTICS								
LINE STEP RESPONSE, 10μs rise	V _{IN} = 16 ↔ 40Vdc, I _o = 100%							
VOLTAGE CHANGE			200			200		mV
RECOVERY TIME (99%)			200			200		μS
WITH 200 μF OUTPUT CAPACITORS ³								
VOLTAGE CHANGE			100			100		mV
RECOVERY TIME (99%)			400			500		μS
LOAD STEP RESPONSE, 10μs rise	I _o = 50-100-50%							
VOLTAGE CHANGE			500			500		mV
RECOVERY TIME (99%)			150			150		μS
WITH 200 μF OUTPUT CAPACITORS ³								
VOLTAGE CHANGE			100			100		mV
RECOVERY TIME (99%)			500			600		μS
START-UP OVERSHOOT	V _{IN} = 0 → 28 Vdc		0			0		mV
SHUTDOWN DELAY	Pin 5 = >10 ↔ <8 Vdc		250	500		250	500	μS
SHUTDOWN RECOVERY	Pin 5 = > 8 ↔ <10Vdc		40	60		40	60	mS

NOTES: 1. Unless otherwise stated T_c = 25°, V_{IN} = 28V, P_o = 5 watts,

2. Regulation measured on output pins 1/16" from case.

PACKAGE & THERMAL SPECIFICATIONS

	MIN	TYP	MAX	UNITS
WEIGHT		14		GRAMS
TEMPERATURE RISE, junction to case		17	25	°C
TEMPERATURE RISE, case to ambient		30		°C/W

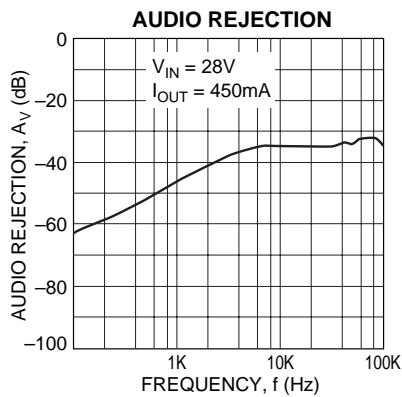
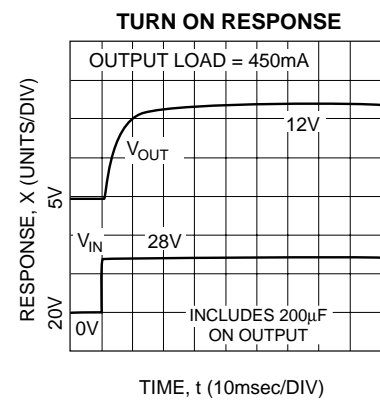
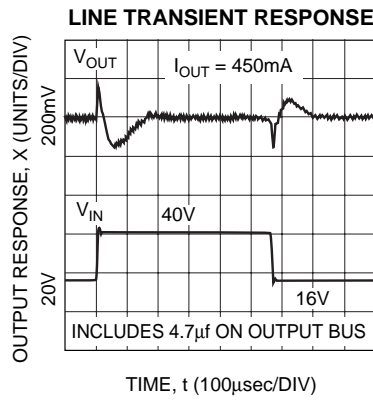
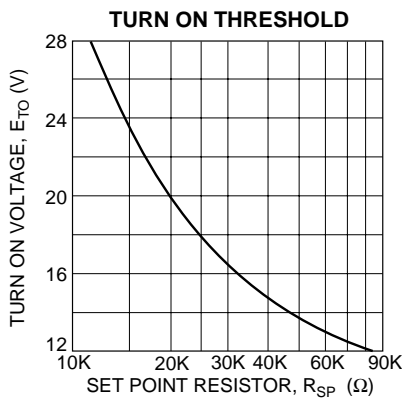
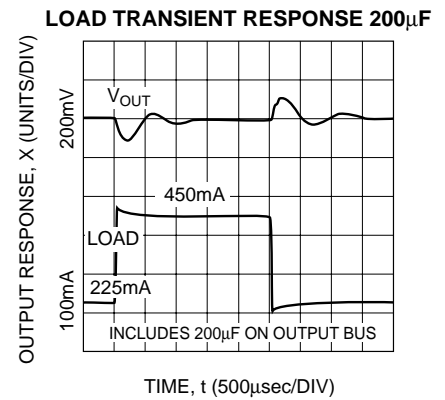
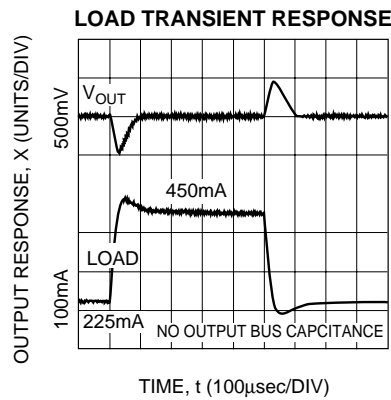
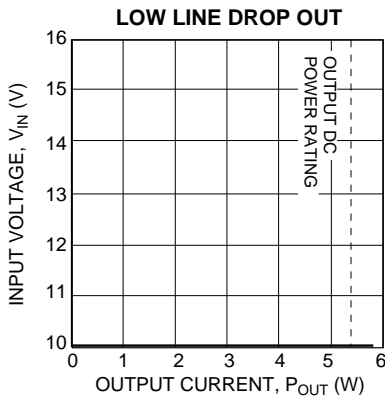
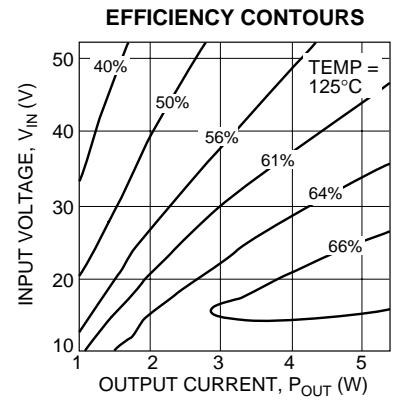
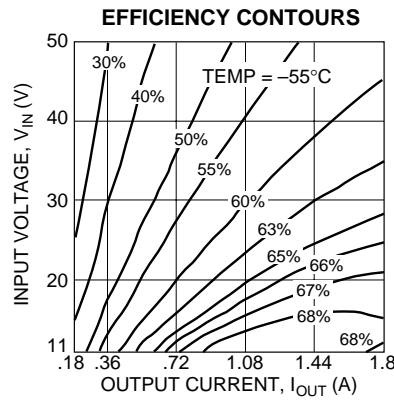
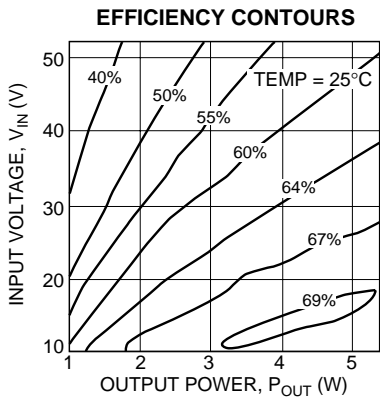

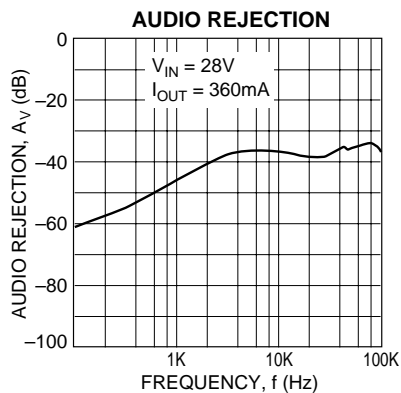
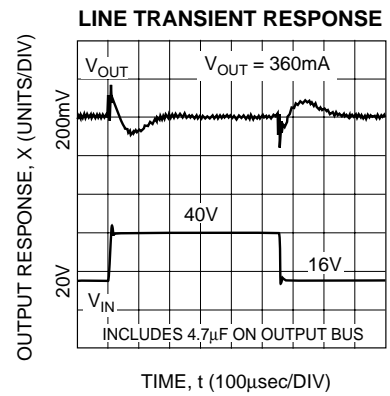
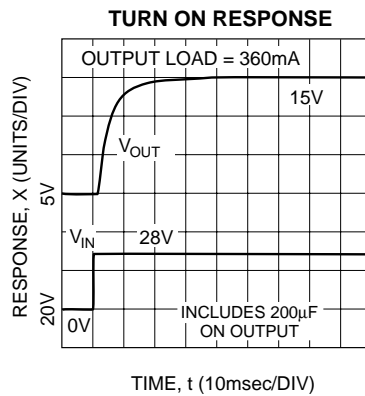
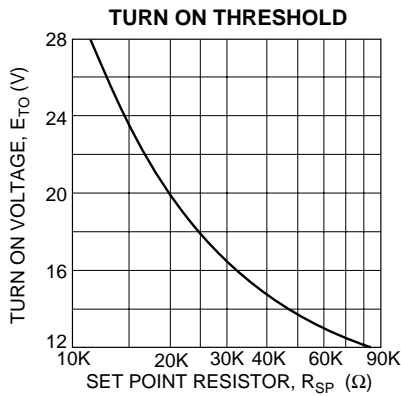
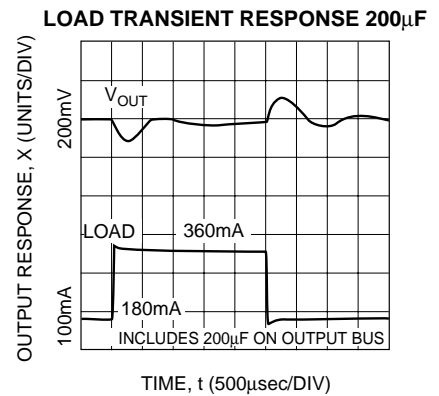
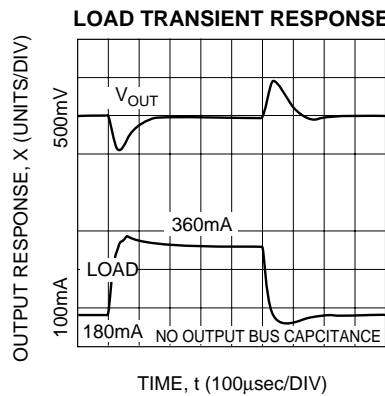
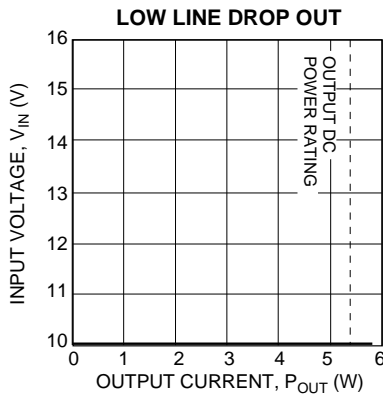
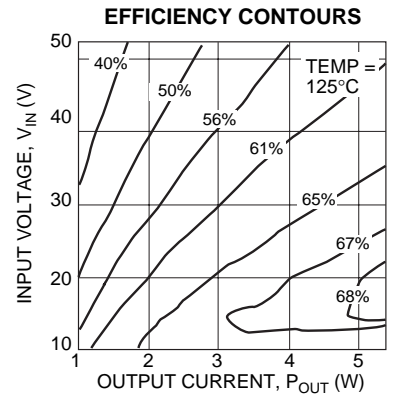
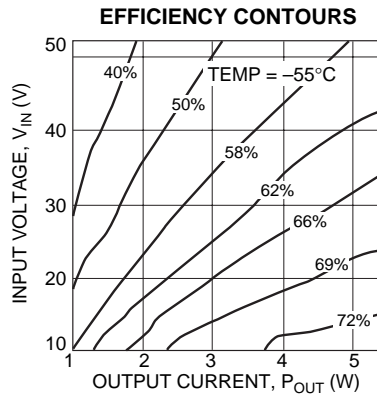
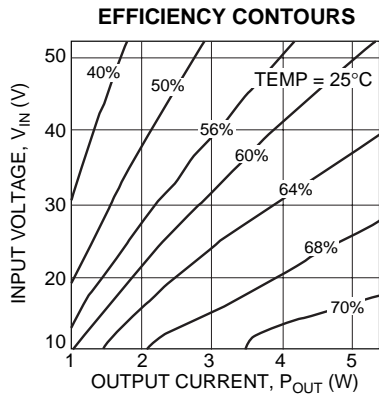

OUTPUT ADJUST / COMP

The output voltage of the DAC2812S and DAC2815S may be adjusted from 90% to 110% of nominal value by the use of a 150KΩ potentiometer as shown. Adjustment beyond this range is possible, however certain characteristics of the converter such as but not limited to input voltage range, efficiency, ripple and temperature performance will change. Characterization by the user is recommended in such applica-

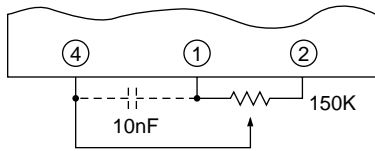

tions.

Adjust/comp (pin 4) may be driven by external circuitry referenced to pin 2 (-output) if desired. Grounding pin 4 causes voltage to increase (25% typically) while driving pin 4 above 1.3 V causes output voltage to decrease. Pin 4 may be driven negative without damage, however the resultant increase in converter output voltage should be considered. Pin 4 may be driven through 10KΩ or more if connection of the comp function is also required.

The comp function of pin 4 allows load transient response to be tailored to suit specific application requirements. This feature may be utilized by connecting a 10 or less nF capacitor between pins 4 and 1.

Note: The DAC2812S and DAC2815S use pin 4 while the DHC2803S and DHC2805S use pin 3.

SHUTDOWN PLUS

Pin 5 is used for remote shutdown, output fault detection, and/or setting the input voltage point at which the converter will turn on as shown in the typical application diagram. No connection to pin 5 is necessary for normal operation of the converter. Pin 5 is referenced to pin 7 (-input).

Shutdown may be implemented by simply connecting pin 5 to an open collector logic output or switch rated at 2.5 mA, 25 Vdc or higher.

Input voltage turn on point is programmed with a single resistor from pin 5 to 7. An input turn on/off hysteresis (typically 3.5% of V_{in}) will be observed. This should be considered when making or verifying set point adjustment. The value of the setpoint resistor may be determined by the following:

$$R = \frac{210 * 10^3}{E_{TO} - 9.5} \quad (+/- 10\% \text{ accuracy at } 25^{\circ}\text{C})$$

Set point temperature coefficient is typically + 400ppm/°C

Output fault monitoring is accomplished by observing pin 5

with a high impedance monitoring circuit. Pin 5 voltage drops from over 10 V to below 1 V when a load fault causes the converters fault protection circuitry to activate. It will remain low for at least 100 mS and return high. If the load fault is still present pin 5 will return low and the cycle will repeat. A resistor > 400 KΩ from pin 5 to 7 provides pull down for pin 5 if there is no input setpoint programming resistor already in place.

LOAD FAULT RESPONSE

The MSK families of DC-DC converters share load fault philosophies. Load fault conditions include short-circuit and severe overload conditions. The DAC2800 converter series responds to load faults by turning off all power conversion circuits for 250 mS and then attempting to restart for 10 mS (typical). The net "on" duty factor during a fault is very low resulting in low converter dissipation and immunity from overheating at 125°C. Current beyond rated can flow into the load at startup time. This allows the converter to bring up capacitive and other difficult load types more reliably than competing converters.

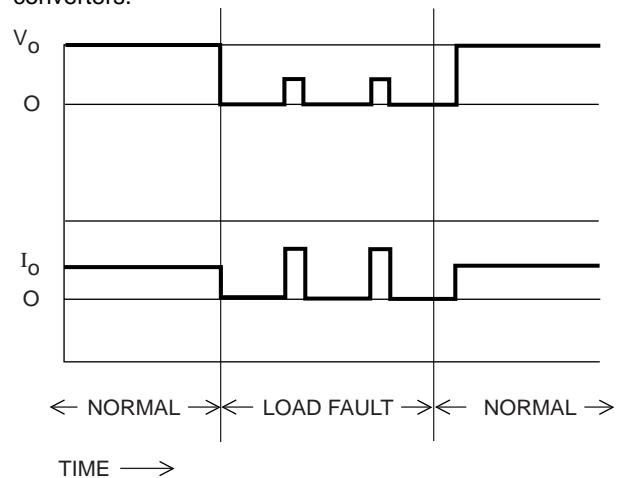

MECHANICAL SPECIFICATIONS

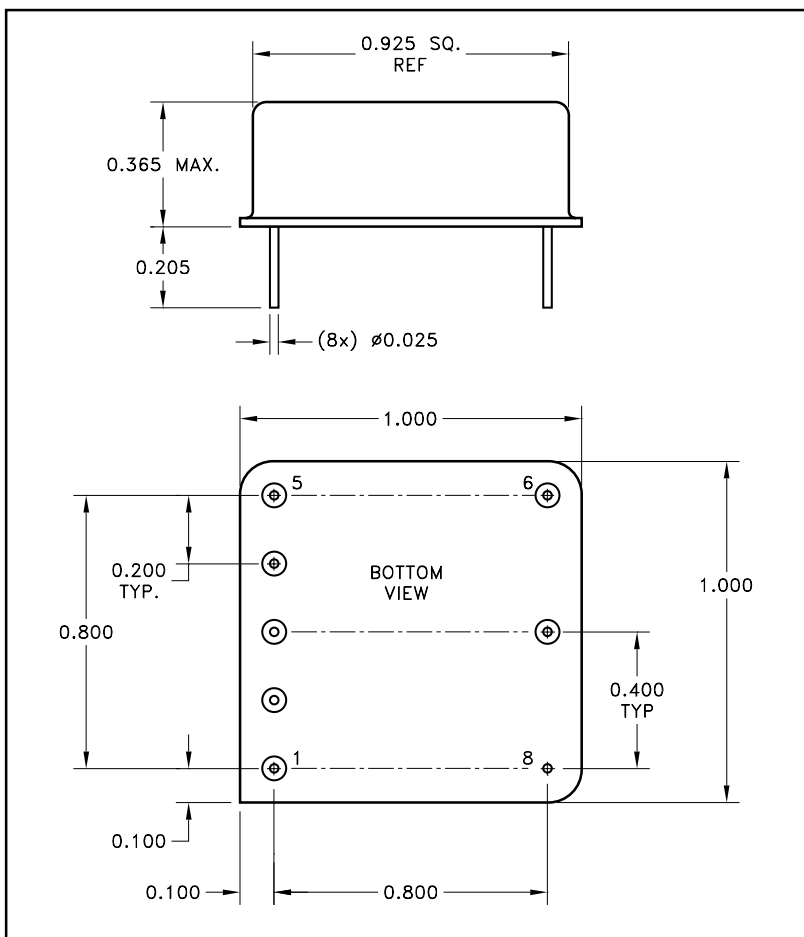

NOTE: ALL DIMENSIONS ARE ±0.010 INCHES UNLESS OTHERWISE LABELED.
ESD Triangle indicates Pin 1.

ORDERING INFORMATION

DAC2812S

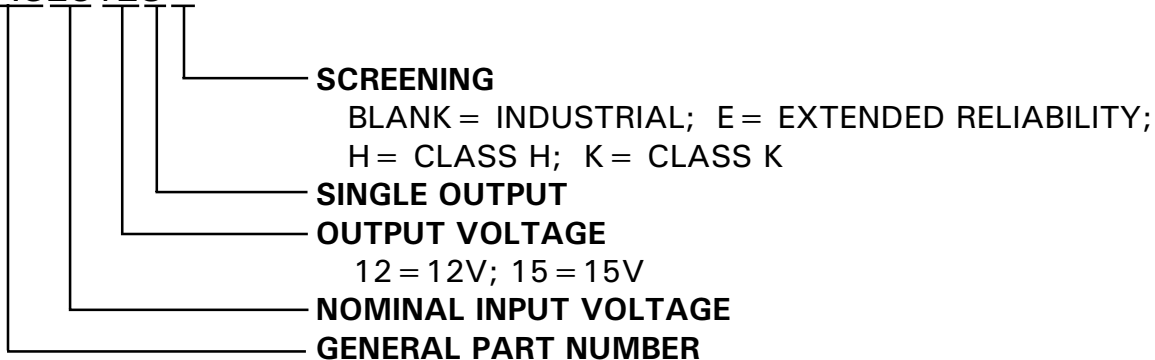

The above example is an industrial grade 12V single output converter

M.S. Kennedy Corp.
4707 Dey Road, Liverpool, New York 13088
Phone (315) 701-6751
FAX (315) 701-6752
www.mskennedy.com

The information contained herein is believed to be accurate at the time of printing. MSK reserves the right to make changes to its products or specifications without notice, however, and assumes no liability for the use of its products. Please visit our website for the most recent revision of this datasheet.