



Features

- High OIP3=35dBm at 1960MHz
- Low DC Power: 3.3V, 23mA
- Low NF = 1.6dB at 1960MHz
- 50MHz to 3000MHz Operation
- Power Down Capability
- Class 1C (1000V) HBM ESD Rating
- MSL 1 Rating
- Common Platform Compatible

Applications

- Low Power Linear Gain Stage
- IF, Cellular, DCS, PCS, UMTS, WLAN, WiMax, TD-SCDMA, LTE Amplifiers
- Low Power LNA

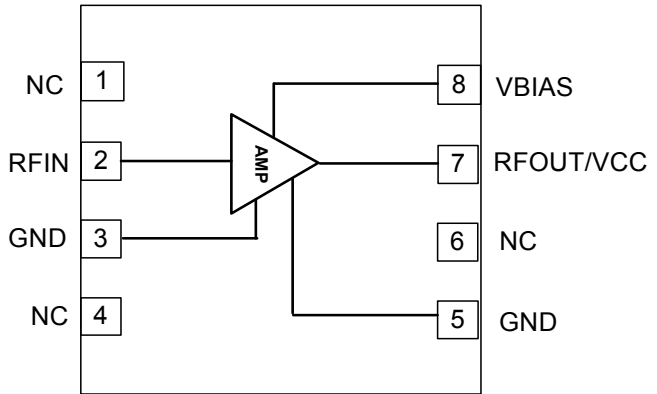

Functional Block Diagram

Product Description

The RFGA2012 is specifically designed to achieve high OIP3 with minimal DC power. Ultra-linear performance has been demonstrated in standard frequency bands within 150MHz to 3GHz. The RFGA2012 features a VBIAS pin that allows users to optimize the quiescent current for specific requirements. The VBIAS pin also serves as a power-down pin. The RFGA2012 offers 1000V HBM ESD ruggedness and is manufactured using RFMD's InGaP HBT process to minimize Beta process variation.

Ordering Information

RFGA2012SR	7" Reel with 100 pieces
RFGA2012SQ	25-piece sample bag
RFGA2012TR7	7" Reel with 750 pieces
RFGA2012TR13	13" Reel with 2500 pieces
RFGA2012PCK-410	1800MHz to 2200MHz PCBA with 5-piece sample bag
RFGA2012PCK-411	2600MHz to 2700MHz PCBA with 5-piece sample bag

Optimum Technology Matching® Applied

- | | | | |
|---|--------------------------------------|-------------------------------------|-----------------------------------|
| <input type="checkbox"/> GaAs HBT | <input type="checkbox"/> SiGe BiCMOS | <input type="checkbox"/> GaAs pHEMT | <input type="checkbox"/> GaN HEMT |
| <input type="checkbox"/> GaAs MESFET | <input type="checkbox"/> Si BiCMOS | <input type="checkbox"/> Si CMOS | <input type="checkbox"/> RF MEMS |
| <input checked="" type="checkbox"/> InGaP HBT | <input type="checkbox"/> SiGe HBT | <input type="checkbox"/> Si BJT | <input type="checkbox"/> LDMOS |

RF MICRO DEVICES®, RFMD®, Optimum Technology Matching®, Enabling Wireless Connectivity™, PowerStart®, POLARIS™ TOTAL RADIO™ and UltimateBlue™ are trademarks of RFMD, LLC. BLUETOOTH is a trademark owned by Bluetooth SIG, Inc., U.S.A. and licensed for use by RFMD. All other trade names, trademarks and registered trademarks are the property of their respective owners. ©2006, RF Micro Devices, Inc.

Absolute Maximum Ratings

Parameter	Rating	Unit
Collector-to-Emitter Voltage (V_{CE})	5.5	V
DC Supply Current (Ic)	35	mA
CW Input Power, 2:1 Output VSWR, 5.0V	+20	dBm
CW Input Power, 2:1 Output VSWR, 5.5V	+15	dBm
Output Load VSWR at P3dB	5:1	dBm
Operating Temperature Range (T_L)	-40 to +85	°C
Operating Junction Temperature (T_J)	150	°C
Max Storage Temperature	-40 to +150	°C
ESD Rating - Human Body Model (HBM)	Class 1C	
Moisture Sensitivity Level	MSL 1	



Caution! ESD sensitive device.

Exceeding any one or a combination of the Absolute Maximum Rating conditions may cause permanent damage to the device. Extended application of Absolute Maximum Rating conditions to the device may reduce device reliability. Specified typical performance or functional operation of the device under Absolute Maximum Rating conditions is not implied.

RoHS status based on EUDirective2002/95/EC (at time of this document revision).

The information in this publication is believed to be accurate and reliable. However, no responsibility is assumed by RF Micro Devices, Inc. ("RFMD") for its use, nor for any infringement of patents, or other rights of third parties, resulting from its use. No license is granted by implication or otherwise under any patent or patent rights of RFMD. RFMD reserves the right to change component circuitry, recommended application circuitry and specifications at any time without prior notice.

Notes:

1. The maximum ratings must all be met simultaneously.
2. $P_{DISS} = P_{DC} + P_{RFIN} - P_{RFOUT}$
3. $T_J = T_L + P_{DISS} * R_{TH}$

Parameter	Specification			Unit	Condition
	Min.	Typ.	Max.		
150MHz					$V_{CC} = 3.3V, I_{CQ} = 23mA$ (includes I_{BIAS})
Frequency	130	150	270	MHz	
Gain		25		dB	
Input Return Loss		14		dB	
Output Return Loss		14		dB	
P1dB		12.5		dBm	
OIP3		30		dBm	0dBm/ tone, tone spacing = 1MHz
Noise Figure		3.8		dB	
900MHz					$V_{CC} = 3.3V, I_{CQ} = 23mA$ (includes I_{BIAS})
Frequency	869	915	960	MHz	
Gain		19		dB	
Input Return Loss		14		dB	
Output Return Loss		14		dB	
P1dB		14.5		dBm	
OIP3		34.5		dBm	0dBm/ tone, tone spacing = 1MHz
Noise Figure		2.7		dB	
1960MHz					$V_{CC} = 3.3V, I_{CQ} = 23mA$ (includes I_{BIAS})
Frequency	1800	1960	2200	MHz	
Gain		14.5		dB	
Input Return Loss		10		dB	
Output Return Loss		14.5		dB	
P1dB		13.5		dBm	
OIP3		35		dBm	0dBm/ tone, tone spacing = 1MHz
Noise Figure		1.6		dB	

Parameter	Specification			Unit	Condition
	Min.	Typ.	Max.		
2650MHz					$V_{CC} = 3.3V, I_{CQ} = 23\text{ mA}$ (includes I_{BIAS})
Frequency	2600	2650	2700	MHz	
Gain		12		dB	
Input Return Loss		11		dB	
Output Return Loss		16		dB	
P1dB		15		dBm	
OIP3		34		dBm	0dBm/tone, tone spacing = 1 MHz
Noise Figure		1.6		dB	
Power Supply					
Operating Current ($I_{CQ} + I_{BIAS}$), Quiescent		23.0		mA	$V_{CE}=3.3V$ (includes I_{BIAS} current ~2.3mA), per 1960 EVB
Recommended Operating Voltage (V_{CE})		3.3	5.0	V	Collector-to-Emitter operating voltage
Power Down Current			20	μA	$V_{BIAS}=0.0V, V_{CE}=3.3V$
Thermal Resistance (R_{TH})		365		C/W	See R_{TH} graph on page 3

Typical Performance: 1800MHz to 2200MHz Application Circuit

S11 versus Frequency

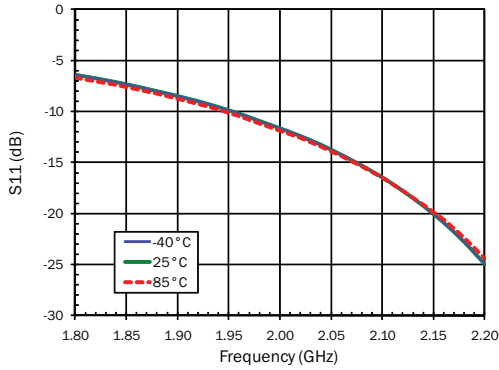

S21 versus Frequency

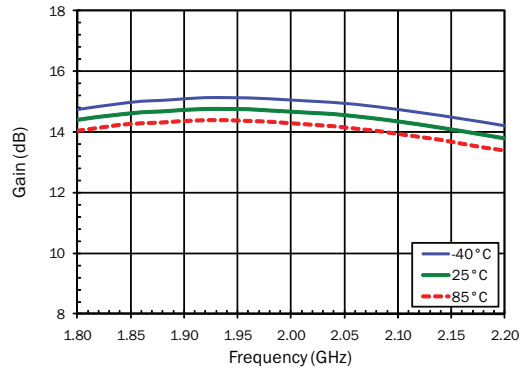

S12 versus Frequency

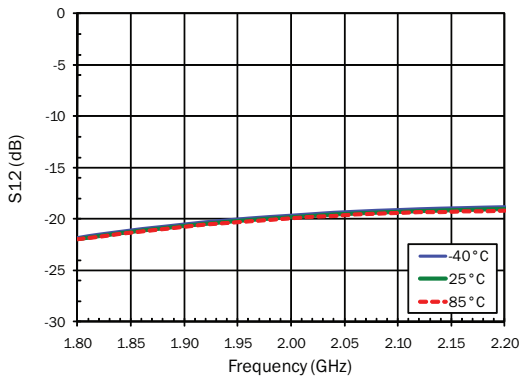

S22 versus Frequency

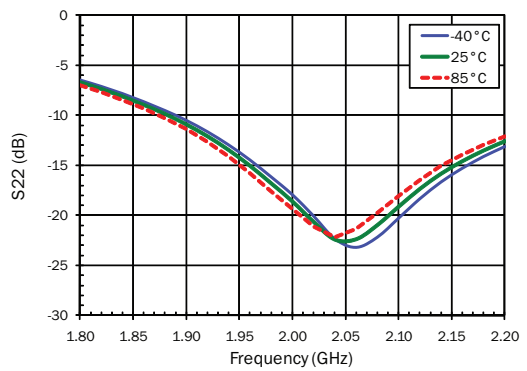

Tjmax vs. Voltage and Output Power (1960MHz)

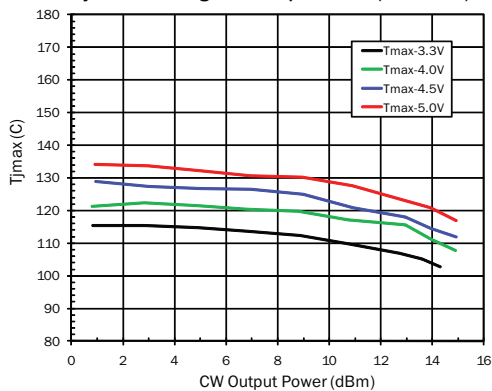

Rth vs. Voltage and Output Power (1960MHz)

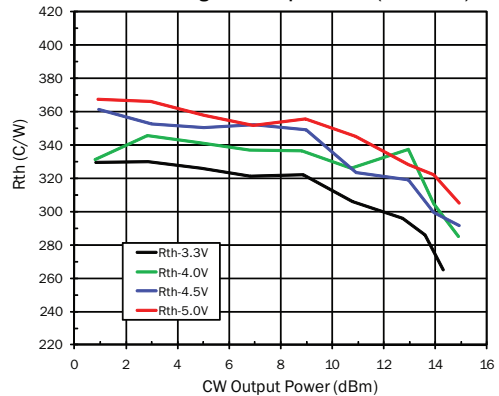

Typical Performance: 1800MHz to 2200MHz Application Circuit

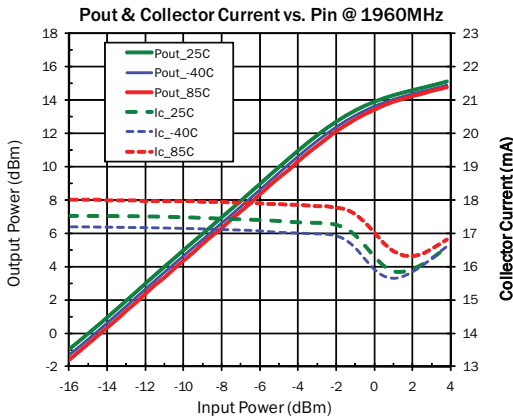
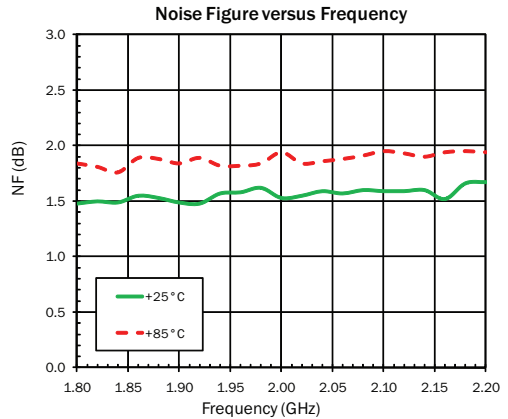
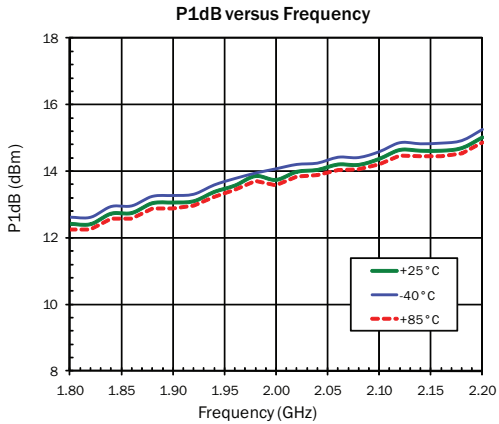
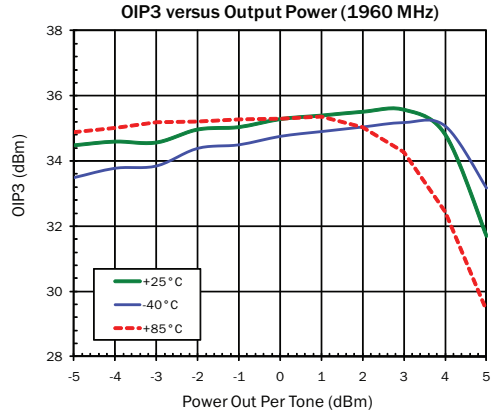
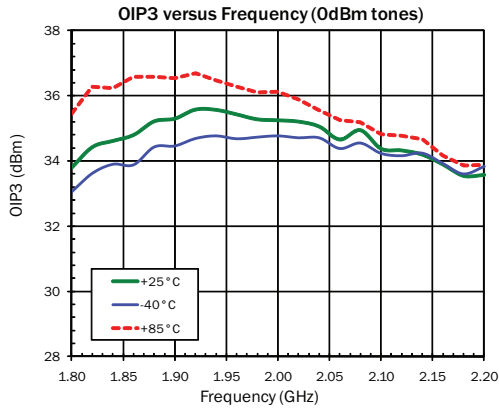

Evaluation Board Schematic 1800MHz to 2200MHz Application Circuit

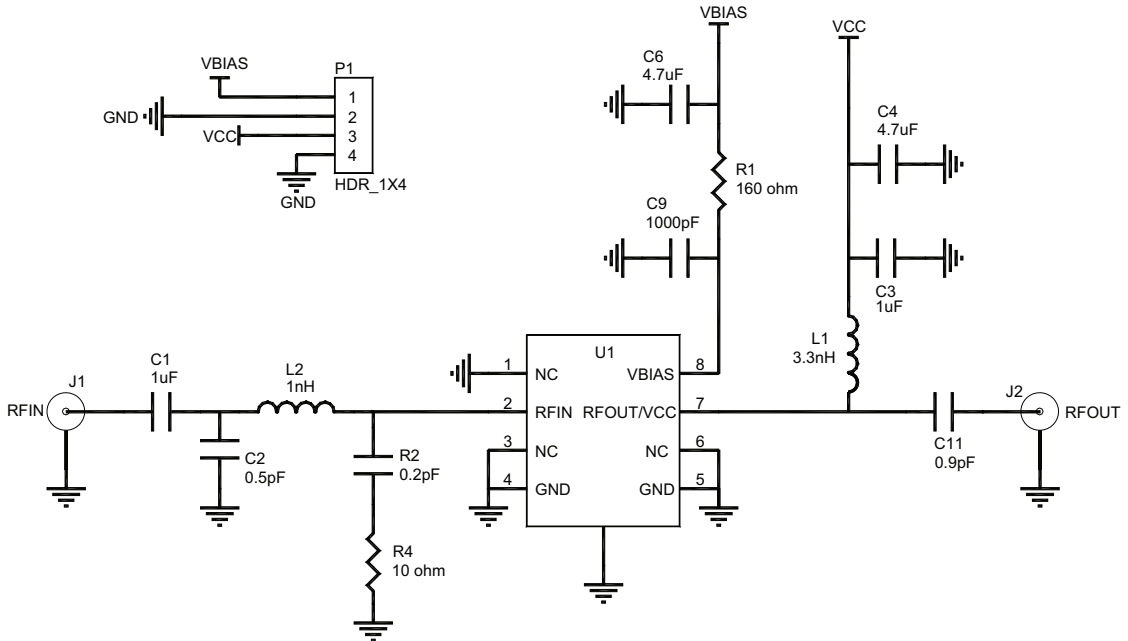

Evaluation Board BOM 1800MHz to 2200MHz Application Circuit

Description	Reference Designator	Manufacturer	Manufacturer's P/N
PCB			GA2012410(A)
Low Noise, Linear Gain Block Amplifier	U1	RFMD	RFGA2012
CAP, 4.7uF, 10%, 10V, X5R, 0603	C4, C6	TDK Corporation	C1608X5R1A475K
CAP, 1000pF, 10%, 50V, X7R, 0402	C9	Murata Electronics	GRM155R71H102KA01E
CAP, 1uF, 10%, 10V, X5R, 0402	C1, C3	Murata Electronics	GRM155R61A105KE15D
CAP, 0.5pF, +/-0.1pF, 50V, HI-Q, 0402	C2	Johanson Technology	500R07S0R5BV4TD
CAP, 0.2pF, +/-0.05pF, 50V, HI-Q, 0402	R2	Johanson Technology	500R07S0R2AV4TD
CAP, 0.9pF, +/-0.1pF, 50V, HI-Q, 0402	C11	Johanson Technology	500R07S0R9BV4TD
IND, 1nH, +/-0.1nH, T/F, 0402	L2	Murata Electronics	LQP15MN1N0B02D
IND, 3.3nH, +/-0.1nH, T/F, 0402	L1	Murata Electronics	LQP15MN3N3B02D
RES, 160Ω, 5%, 1/16W, 0402	R1	Kamaya, Inc	RMC1/16S-161JTH
RES, 10Ω, 5%, 1/16W, 0402	R4	Kamaya, Inc	RMC1/16S-100JTH
CONN, SMA, END LNCH, FLT, 0.062"	J1, J2	Emerson Network Power	142-0701-821
CONN, HDR, ST, PLRZD, 4-PIN, 0.100"	P1	ITW Pancon	MPSS100-4-C
DNP	C5, C7, C8, C10, C14, R3		

Evaluation Board Assembly Drawing
1800MHz to 2200MHz Application Circuit

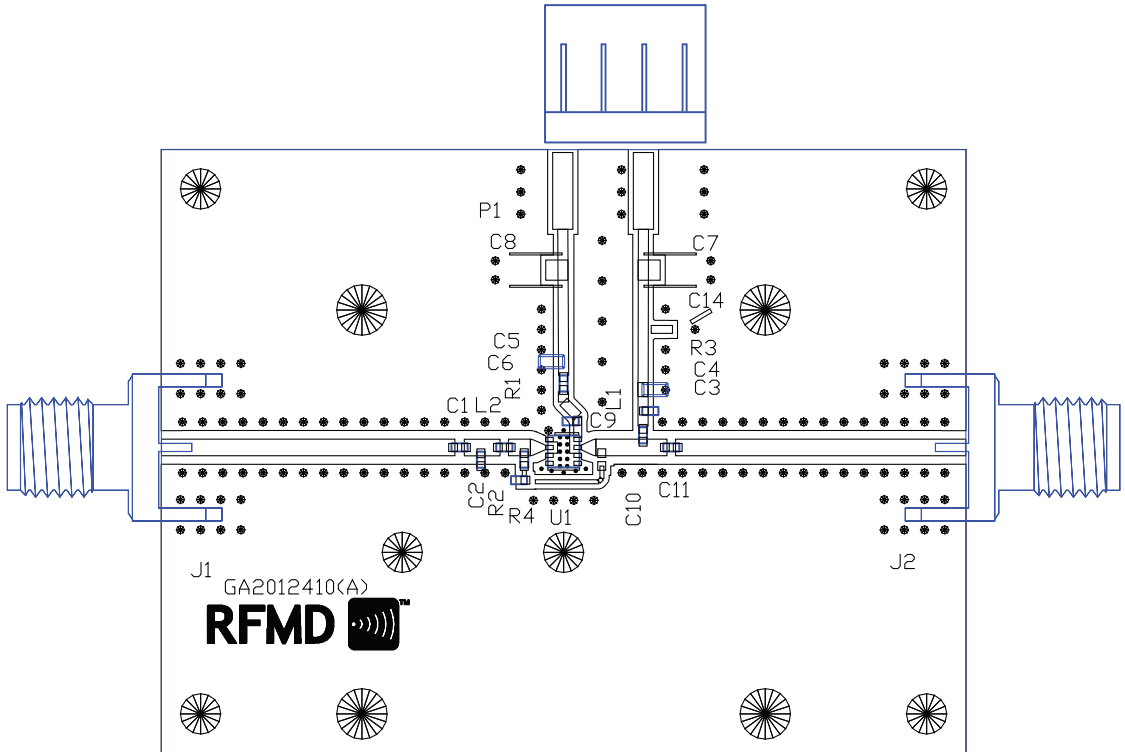

Typical Performance: 2600MHz to 2700MHz Application Circuit

S11 versus Frequency

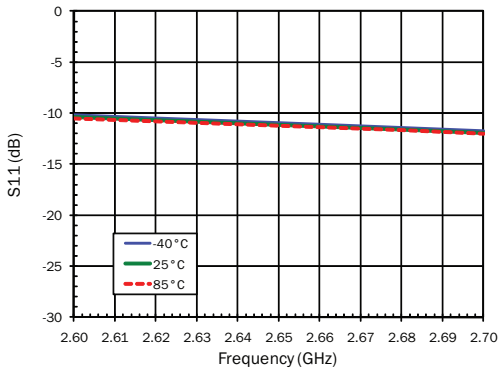

S21 versus Frequency

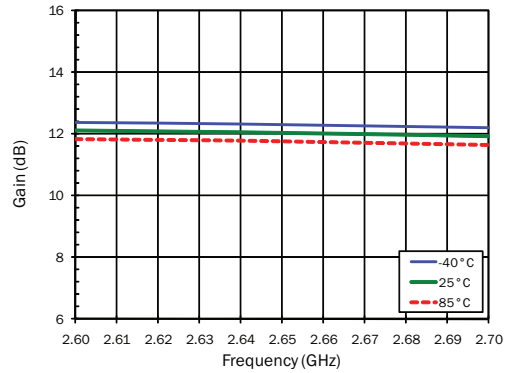

S12 versus Frequency

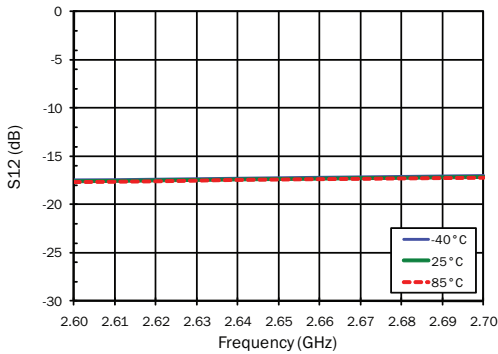

S22 versus Frequency

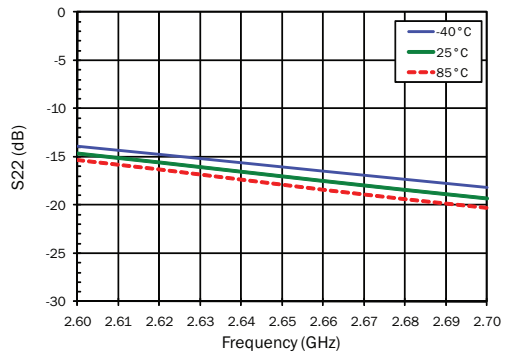

Typical Performance: 2600MHz to 2700MHz Application Circuit

OIP3 versus Frequency (0dBm tones)

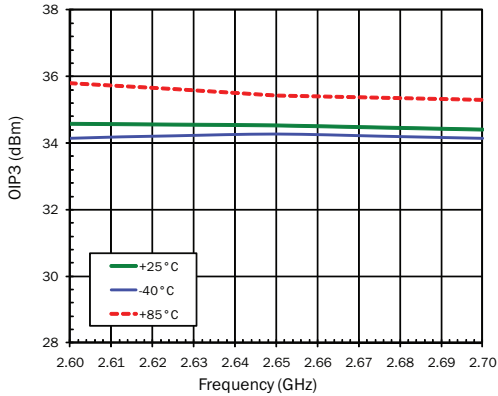

OIP3 versus Output Power (2650 MHz)

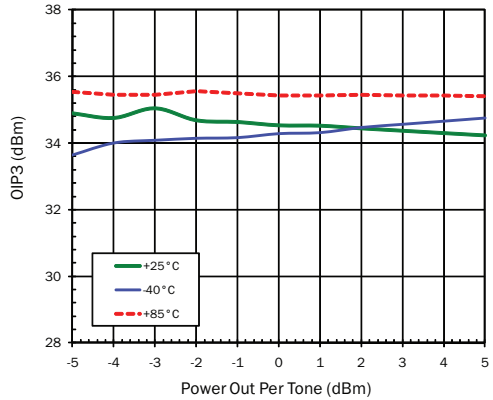

P1dB versus Frequency

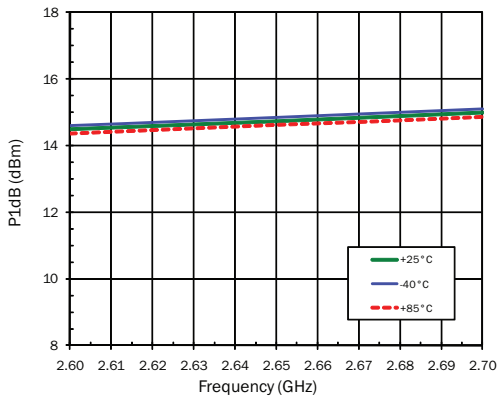

Noise Figure versus Frequency

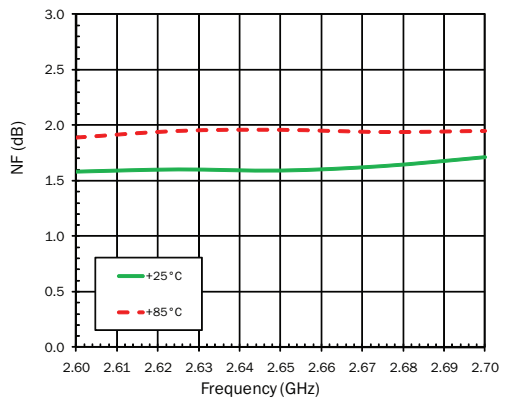

Pout & Collector Current vs. Pin @ 2650MHz

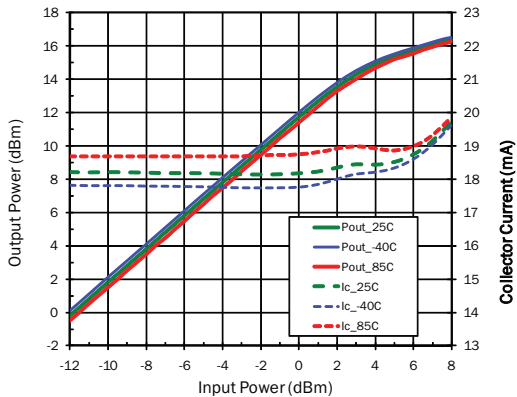

Evaluation Board Schematic 2600MHz to 2700MHz Application Circuit

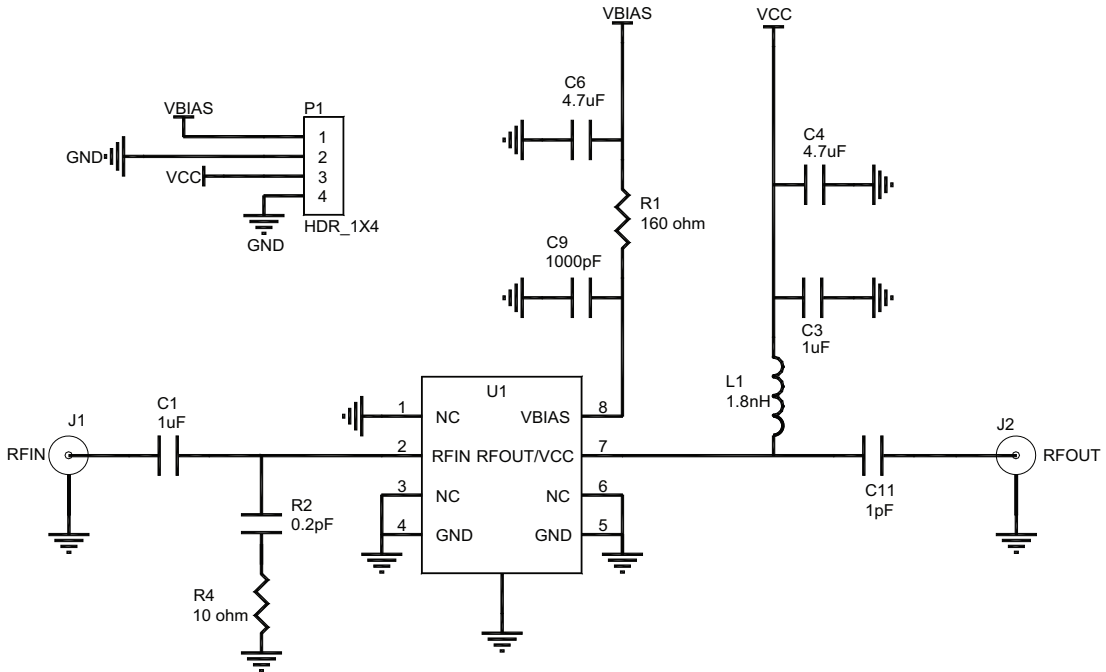

Evaluation Board BOM 2600MHz to 2700MHz Application Circuit

Description	Reference Designator	Manufacturer	Manufacturer's P/N
PCB			GA2012411(A)
Low Noise, Linear Gain Block Amplifier	U1	RFMD	RFGA2012
CAP, 4.7uF, 10%, 10V, X5R, 0603	C6, C4	TDK Corporation	C1608X5R1A475K
CAP, 1000pF, 10%, 50V, X7R, 0402	C9	Murata Electronics	GRM155R71H102KA01E
CAP, 1uF, 10%, 10V, X5R, 0402	C1, C3	Murata Electronics	GRM155R61A105KE15D
CAP, 0.2pF, +/-0.05pF, 50V, HI-Q, 0402	R2	Johanson Technology	500R07S0R2AV4TD
CAP, 1pF, +/-0.1pF, 50V, HI-Q, 0402	C11	Johanson Technology	500R07S1R0BV4TD
IND, 1.8nH, +/-0.1nH, T/F, 0402	L1	Murata Electronics	LQP15MN1N8B02D
RES, 160Ω, 5%, 1/16W, 0402	R1	Kamaya, Inc	RMC1/16S-161JTH
RES, 10Ω, 5%, 1/16W, 0402	R4	Kamaya, Inc	RMC1/16S-100JTH
CONN, SMA, END LNCH, FLT, 0.062"	J1, J2	Emerson Network Power	142-0701-821
CONN, HDR, ST, PLRZD, 4-PIN, 0.100"	P1	ITW Pancon	MPSS100-4-C
DNP	C5, C7, C8, C10, C14, R3		

Evaluation Board Assembly Drawing
2600MHz to 2700MHz Application Circuit

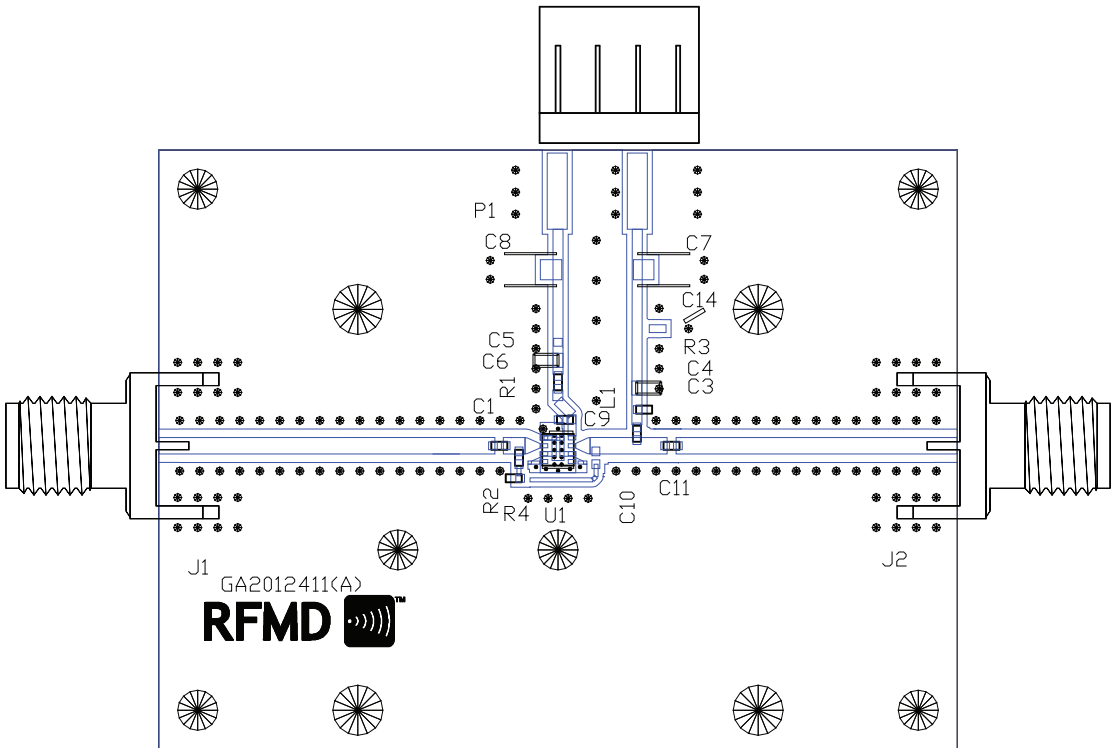

Pin Table and Description

Pin	Function	Description
1	NC	No Internal Connection
2	RF IN	RF Input. External DC Block is Required
3	GND	Ground
4	NC	No Internal Connection
5	GND	Ground
6	NC	No Internal Connection
7	RF OUT	RF Output, Device Collector
8	VBIAS	Supply Voltage for Bias Circuit, Power-down Pin
EPAD	NC	Thermal Ground. Must be Soldered to EVB Ground Plane Over a Bed of Vias.

Package Drawing

Dimensions in inches (millimeters)

Refer to drawing posted at www.rfmd.com for tolerances

TOP VIEW

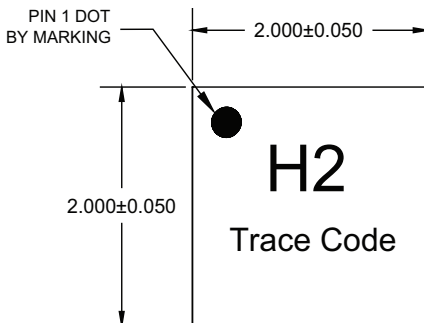

BOTTOM VIEW

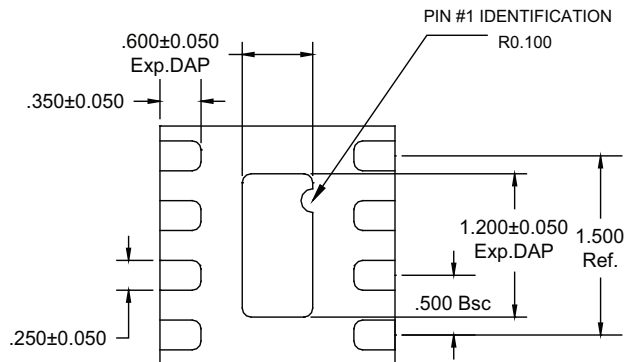

Trace Code to be assigned by assembly SubCon

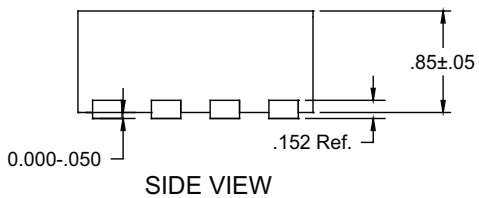

SIDE VIEW