



## N-Channel Logic Level Enhancement Mode Field Effect Transistor

### PRODUCT SUMMARY

VDSS	ID	RDS(ON) ( $\Omega$ ) Max
200V	1A	1.8 @ VGS=10V
		2.0 @ VGS=4.5V

### FEATURES

- Super high dense cell design for low  $R_{DS(ON)}$ .
- Rugged and reliable.
- Surface Mount Package.



### ABSOLUTE MAXIMUM RATINGS ( $T_A=25^\circ\text{C}$ unless otherwise noted)

Symbol	Parameter	Limit	Units
$V_{DS}$	Drain-Source Voltage	200	V
$V_{GS}$	Gate-Source Voltage	$\pm 20$	V
$I_D$	Drain Current-Continuous <sup>a</sup>	$T_A=25^\circ\text{C}$	1
		$T_A=70^\circ\text{C}$	0.8
$I_{DM}$	-Pulsed <sup>b</sup>	6.6	A
$P_D$	Maximum Power Dissipation <sup>a</sup>	$T_A=25^\circ\text{C}$	3
		$T_A=70^\circ\text{C}$	1.9
$T_J, T_{STG}$	Operating Junction and Storage Temperature Range	-55 to 150	$^\circ\text{C}$

### THERMAL CHARACTERISTICS

$R_{\theta JA}$	Thermal Resistance, Junction-to-Ambient <sup>a</sup>	42	$^\circ\text{C/W}$
-----------------	--	----	--------------------

# STT04N20

Ver 1.0

## ELECTRICAL CHARACTERISTICS (T<sub>A</sub>=25°C unless otherwise noted)

Symbol	Parameter	Conditions	Min	Typ	Max	Units
<b>OFF CHARACTERISTICS</b>						
BV <sub>DSS</sub>	Drain-Source Breakdown Voltage	V <sub>GS</sub> =0V , I <sub>D</sub> =250uA	200			V
I <sub>DSS</sub>	Zero Gate Voltage Drain Current	V <sub>DS</sub> =160V , V <sub>GS</sub> =0V			1	uA
I <sub>GSS</sub>	Gate-Body Leakage Current	V <sub>GS</sub> = ±20V , V <sub>DS</sub> =0V			±100	nA
<b>ON CHARACTERISTICS</b>						
V <sub>GS(th)</sub>	Gate Threshold Voltage	V <sub>DS</sub> =V <sub>GS</sub> , I <sub>D</sub> =250uA	1	1.8	2.5	V
R <sub>DS(ON)</sub>	Drain-Source On-State Resistance	V <sub>GS</sub> =10V , I <sub>D</sub> =0.5A		1.4	1.8	ohm
		V <sub>GS</sub> =4.5V , I <sub>D</sub> =0.5A		1.6	2.0	ohm
g <sub>FS</sub>	Forward Transconductance	V <sub>DS</sub> =10V , I <sub>D</sub> =0.5A		7.5		S
<b>DYNAMIC CHARACTERISTICS <sup>c</sup></b>						
C <sub>ISS</sub>	Input Capacitance	V <sub>DS</sub> =25V, V <sub>GS</sub> =0V f=1.0MHz		385		pF
C <sub>OSS</sub>	Output Capacitance			21		pF
C <sub>RSS</sub>	Reverse Transfer Capacitance			12		pF
<b>SWITCHING CHARACTERISTICS <sup>c</sup></b>						
t <sub>D(ON)</sub>	Turn-On Delay Time	V <sub>DD</sub> =100V I <sub>D</sub> =0.5A V <sub>GS</sub> =10V R <sub>GEN</sub> = 6 ohm		8.3		ns
t <sub>r</sub>	Rise Time			10		ns
t <sub>D(OFF)</sub>	Turn-Off Delay Time			20		ns
t <sub>f</sub>	Fall Time			4.5		ns
Q <sub>g</sub>	Total Gate Charge	V <sub>DS</sub> =100V, I <sub>D</sub> =0.5A, V <sub>GS</sub> =10V		5.7		nC
		V <sub>DS</sub> =100V, I <sub>D</sub> =0.5A, V <sub>GS</sub> =4.5V		3		nC
Q <sub>gs</sub>	Gate-Source Charge	V <sub>DS</sub> =100V, I <sub>D</sub> =0.5A,		0.9		nC
Q <sub>gd</sub>	Gate-Drain Charge	V <sub>GS</sub> =10V		1.2		nC
<b>DRAIN-SOURCE DIODE CHARACTERISTICS AND MAXIMUM RATINGS</b>						
V <sub>SD</sub>	Diode Forward Voltage	V <sub>GS</sub> =0V, I <sub>S</sub> =0.5A		0.81	1.2	V
<b>Notes</b>						
a.Surface Mounted on FR4 Board,t ≤ 10sec.						
b.Pulse Test:Pulse Width ≤ 300us, Duty Cycle ≤ 2%.						
c.Guaranteed by design, not subject to production testing.						

Nov,01,2012

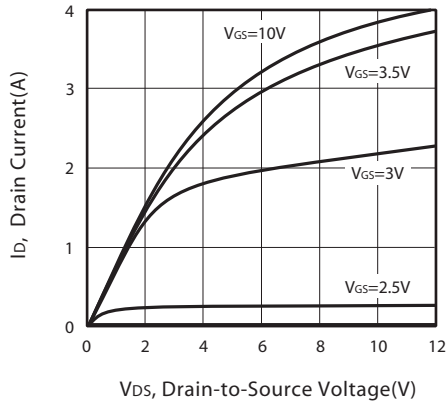

Figure 1. Output Characteristics

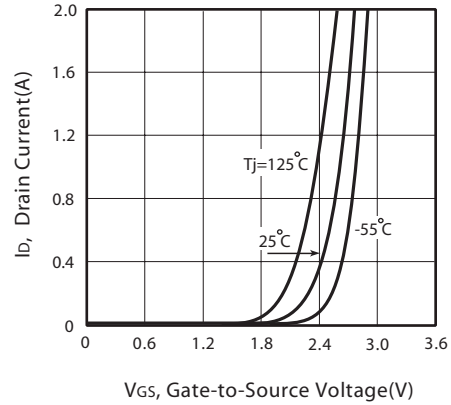

Figure 2. Transfer Characteristics

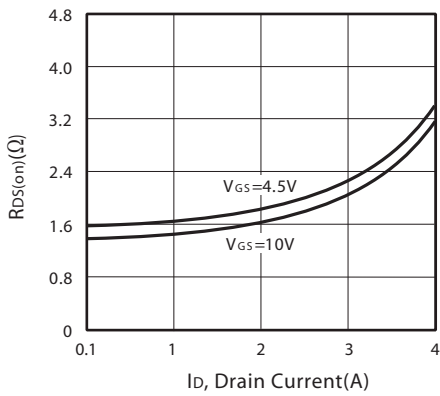

Figure 3. On-Resistance vs. Drain Current and Gate Voltage

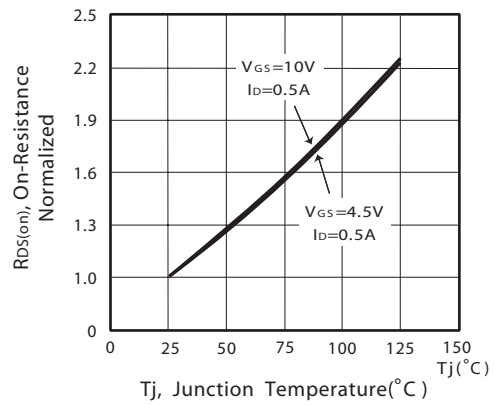

Figure 4. On-Resistance Variation with Drain Current and Temperature

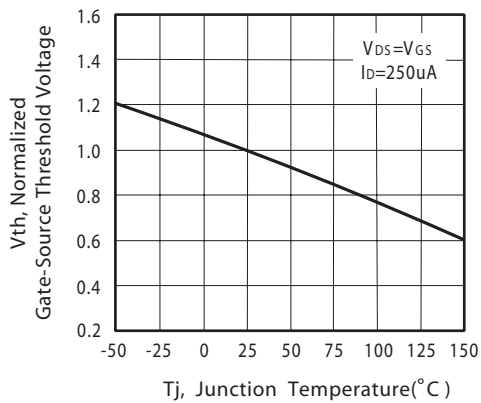

Figure 5. Gate Threshold Variation with Temperature

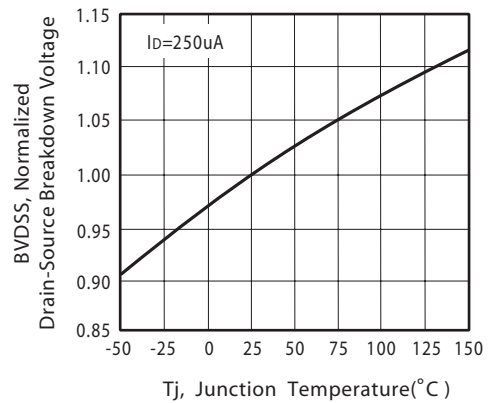

Figure 6. Breakdown Voltage Variation with Temperature

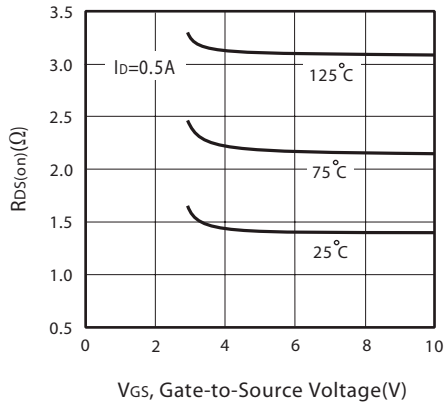

Figure 7. On-Resistance vs. Gate-Source Voltage

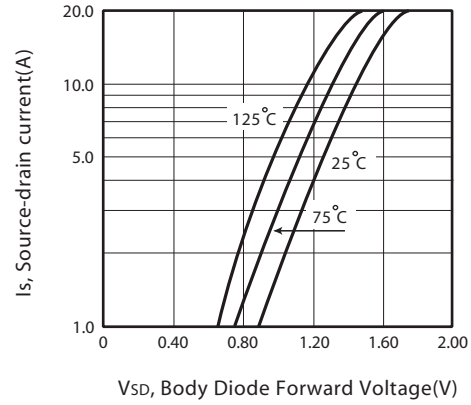

Figure 8. Body Diode Forward Voltage Variation with Source Current

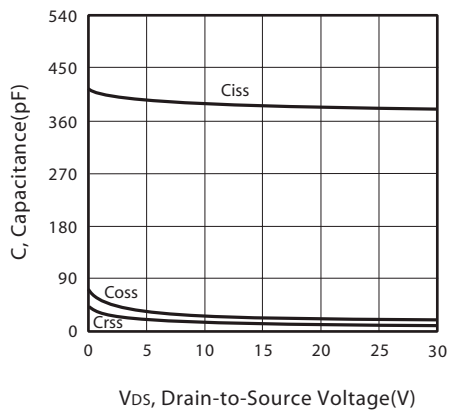

Figure 9. Capacitance

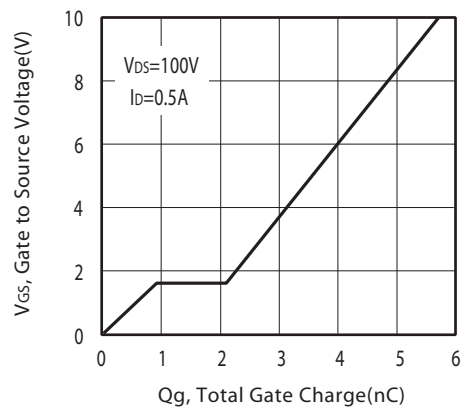

Figure 10. Gate Charge

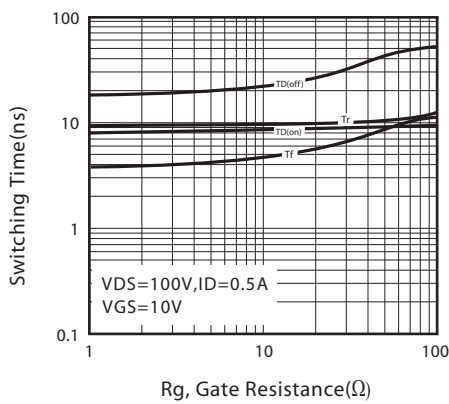

Figure 11. switching characteristics

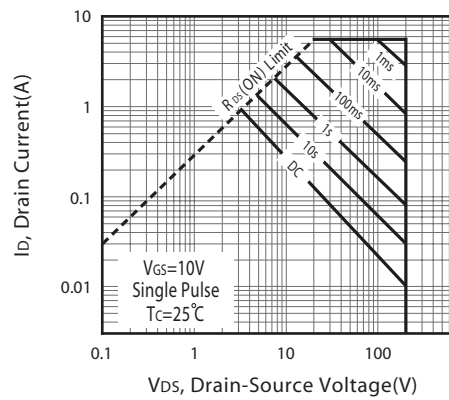

Figure 12. Maximum Safe Operating Area

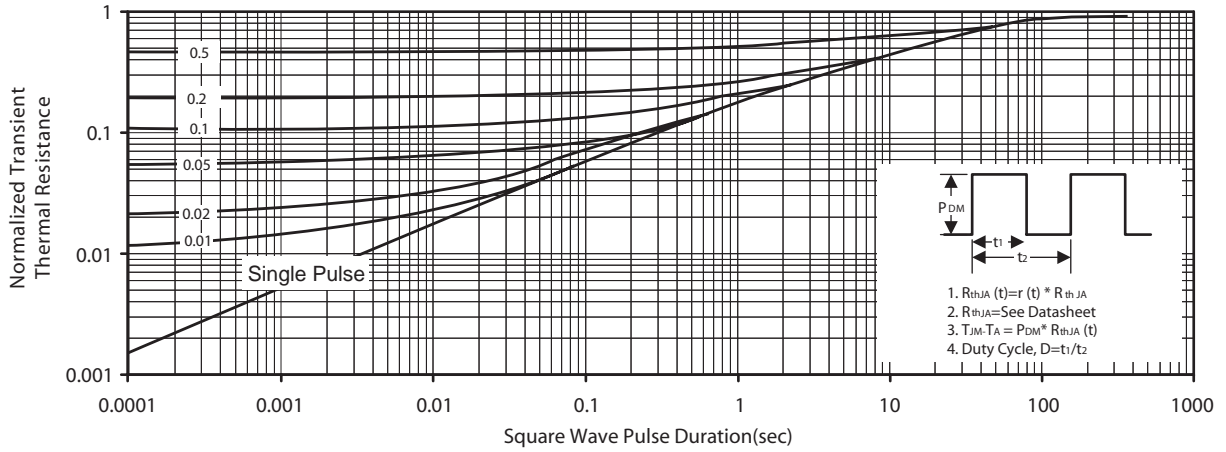
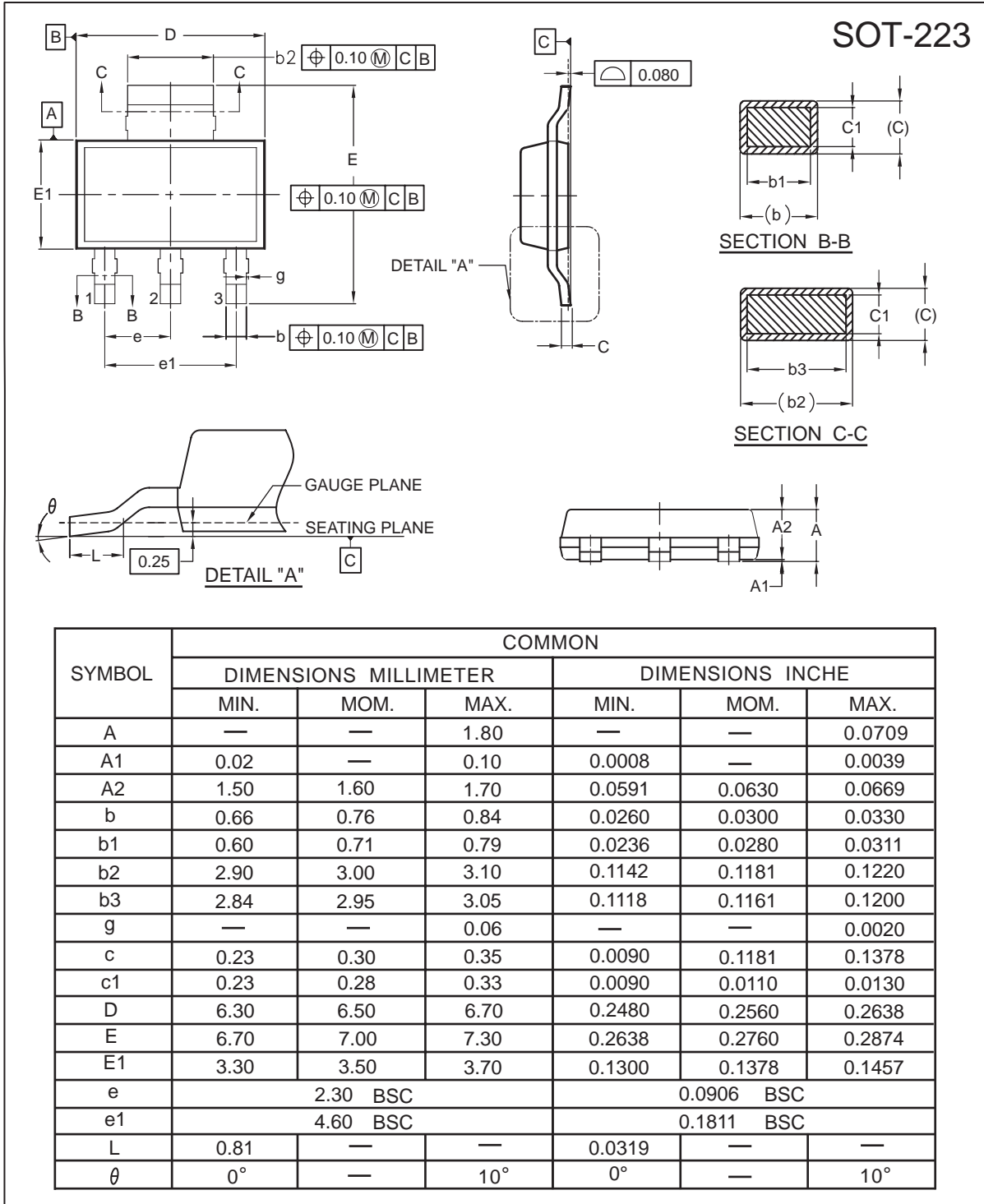

Figure 13. Normalized Thermal Transient Impedance Curve

# STT04N20

Ver 1.0



Nov.01,2012

## SOT-223 Tape and Reel Data

### SOT-223 Carrier Tape

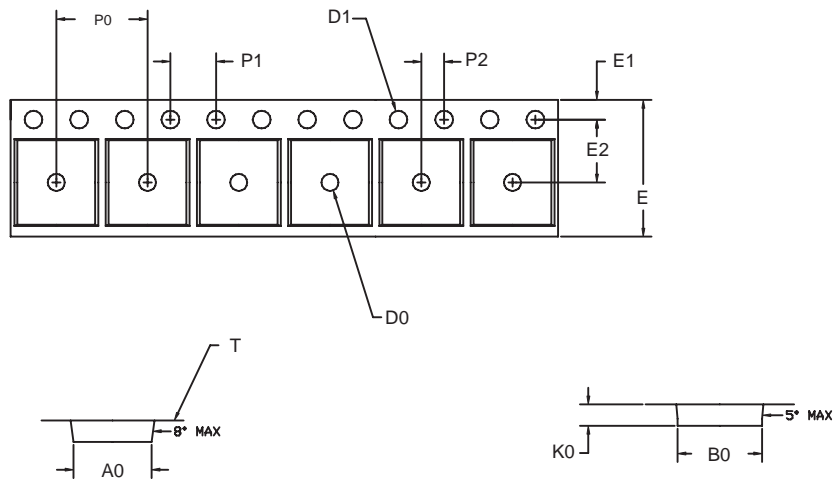

unit: mm

PACKAGE	A0	B0	K0	D0	D1	E	E1	E2	P0	P1	P2	T
---	6.83 ±0.1	7.42 ±0.1	1.88 ±0.1	1.50 +0.25	1.60 +0.1	12.0 +0.3 -0.1	1.75 ±0.1	5.50 ±0.5	8.0 ±0.1	4.00 ±0.1	2.00 ±0.05	0.292 ±0.02

### SOT-223 Reel

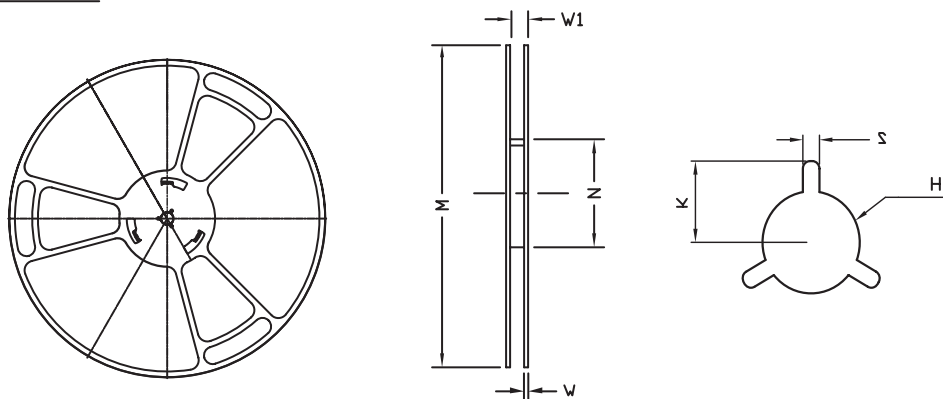

UNIT: mm

REEL SIZE	M	N	W	W1	H	K	S	G	R	V
φ 330 ± 0.5	---	φ 97.0 ± 1.0	2.2	13.0 + 1.5	φ 13.0 + 0.5 - 0.2	10.6	2.0 ± 0.5	---	---	---