



## N-Channel Logic Level Enhancement Mode Field Effect Transistor

### PRODUCT SUMMARY

V <sub>DSS</sub>	I <sub>D</sub>	R <sub>DS(ON)</sub> (mΩ) Max
70V	9A	228 @ V <sub>GS</sub> =10V
		267 @ V <sub>GS</sub> =4.5V

### FEATURES

- Super high dense cell design for low R<sub>DS(ON)</sub>.
- Rugged and reliable.
- TO-252 and TO-251 Package.

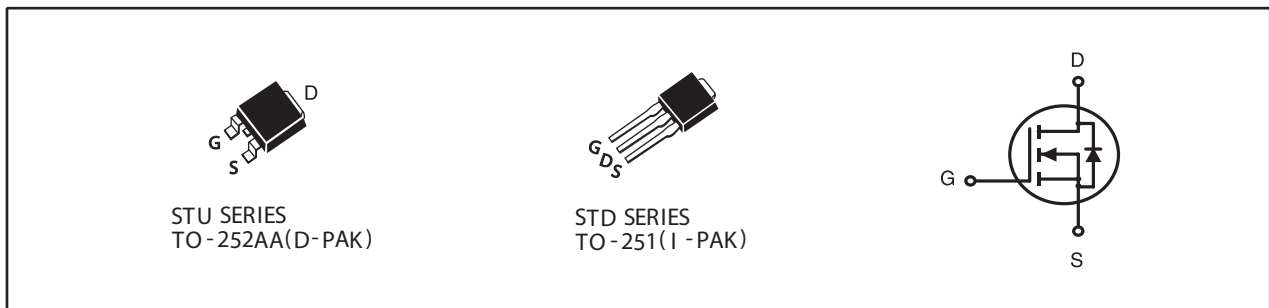

### ABSOLUTE MAXIMUM RATINGS (T<sub>C</sub>=25°C unless otherwise noted)

Symbol	Parameter	Limit	Units
V <sub>DS</sub>	Drain-Source Voltage	70	V
V <sub>GS</sub>	Gate-Source Voltage	±20	V
I <sub>D</sub>	Drain Current-Continuous <sup>a</sup>	T <sub>C</sub> =25°C	9
		T <sub>C</sub> =70°C	7.2
I <sub>DM</sub>	-Pulsed <sup>a</sup>	26	A
E <sub>AS</sub>	Single Pulse Avalanche Energy <sup>c</sup>	12	mJ
P <sub>D</sub>	Maximum Power Dissipation	T <sub>C</sub> =25°C	42
		T <sub>C</sub> =70°C	27
T <sub>J</sub> , T <sub>STG</sub>	Operating Junction and Storage Temperature Range	-55 to 150	°C

### THERMAL CHARACTERISTICS

R <sub>θJC</sub>	Thermal Resistance, Junction-to-Case	3	°C/W
R <sub>θJA</sub>	Thermal Resistance, Junction-to-Ambient	50	°C/W

# STU03L07

## STD03L07

Ver 1.0

### ELECTRICAL CHARACTERISTICS (T<sub>C</sub>=25°C unless otherwise noted)

Symbol	Parameter	Conditions	Min	Typ	Max	Units
<b>OFF CHARACTERISTICS</b>						
BV <sub>DSS</sub>	Drain-Source Breakdown Voltage	V <sub>GS</sub> =0V, I <sub>D</sub> =250uA	70			V
I <sub>DSS</sub>	Zero Gate Voltage Drain Current	V <sub>DS</sub> =56V, V <sub>GS</sub> =0V			1	uA
I <sub>GSS</sub>	Gate-Body Leakage Current	V <sub>GS</sub> = ±20V, V <sub>DS</sub> =0V			±100	nA
<b>ON CHARACTERISTICS</b>						
V <sub>GS(th)</sub>	Gate Threshold Voltage	V <sub>DS</sub> =V <sub>GS</sub> , I <sub>D</sub> =250uA	1	2	3	V
R <sub>DS(ON)</sub>	Drain-Source On-State Resistance	V <sub>GS</sub> =10V, I <sub>D</sub> =4.5A		182	228	m ohm
		V <sub>GS</sub> =4.5V, I <sub>D</sub> =4A		198	267	m ohm
g <sub>FS</sub>	Forward Transconductance	V <sub>DS</sub> =10V, I <sub>D</sub> =4.5A		14		S
<b>DYNAMIC CHARACTERISTICS<sup>b</sup></b>						
C <sub>ISS</sub>	Input Capacitance	V <sub>DS</sub> =25V, V <sub>GS</sub> =0V f=1.0MHz		480		pF
C <sub>OSS</sub>	Output Capacitance			30		pF
C <sub>RSS</sub>	Reverse Transfer Capacitance			22		pF
<b>SWITCHING CHARACTERISTICS<sup>b</sup></b>						
t <sub>D(ON)</sub>	Turn-On Delay Time	V <sub>DD</sub> =35V I <sub>D</sub> =1A V <sub>GS</sub> =10V R <sub>GEN</sub> = 6 ohm		10.5		ns
t <sub>r</sub>	Rise Time			10.2		ns
t <sub>D(OFF)</sub>	Turn-Off Delay Time			19		ns
t <sub>f</sub>	Fall Time			8.2		ns
Q <sub>g</sub>	Total Gate Charge	V <sub>DS</sub> =35V, I <sub>D</sub> =4.5A, V <sub>GS</sub> =10V		7.8		nC
		V <sub>DS</sub> =35V, I <sub>D</sub> =4.5A, V <sub>GS</sub> =4.5V		4		nC
Q <sub>gs</sub>	Gate-Source Charge	V <sub>DS</sub> =35V, I <sub>D</sub> =4.5A,		1.2		nC
Q <sub>gd</sub>	Gate-Drain Charge	V <sub>GS</sub> =10V		2.2		nC
<b>DRAIN-SOURCE DIODE CHARACTERISTICS AND MAXIMUM RATINGS</b>						
V <sub>SD</sub>	Diode Forward Voltage	V <sub>GS</sub> =0V, I <sub>S</sub> =1A		0.81	1.3	V

#### Notes

- Drain current limited by maximum junction temperature.
- Guaranteed by design, not subject to production testing.
- Starting T<sub>J</sub>=25°C, L=0.5mH, V<sub>DD</sub> = 40V. (See Figure13)

Apr,10,2014

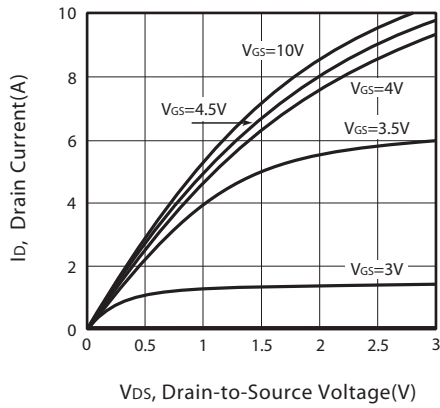

Figure 1. Output Characteristics

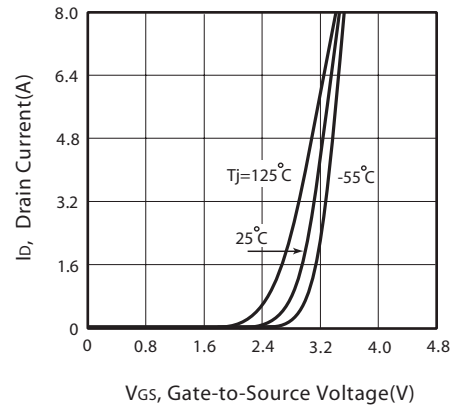

Figure 2. Transfer Characteristics

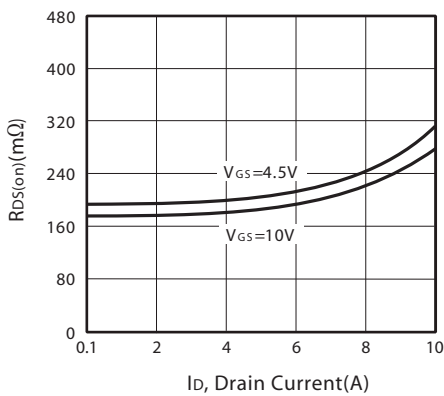

Figure 3. On-Resistance vs. Drain Current and Gate Voltage

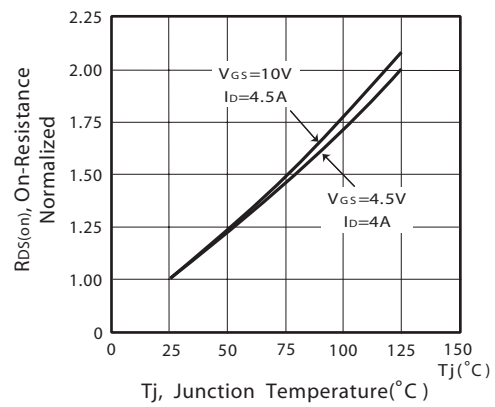

Figure 4. On-Resistance Variation with Drain Current and Temperature

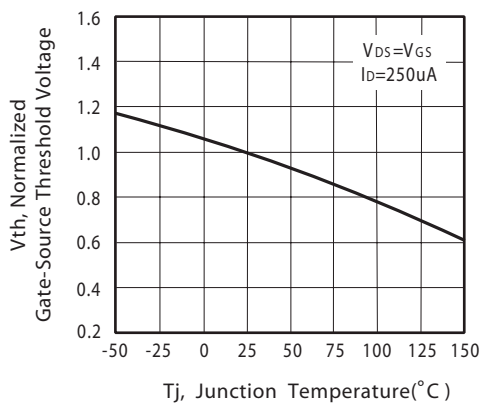

Figure 5. Gate Threshold Variation with Temperature

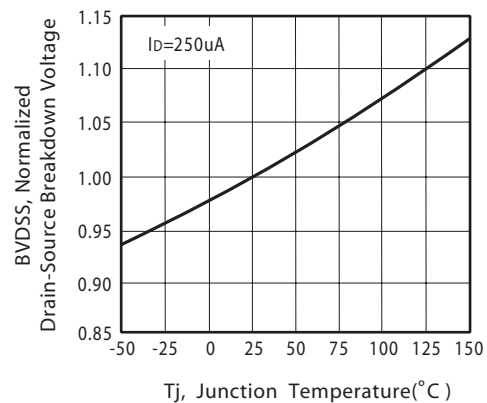

Figure 6. Breakdown Voltage Variation with Temperature

# STU03L07 STD03L07

Ver 1.0

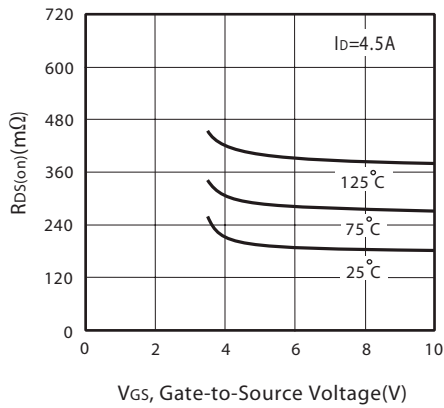

Figure 7. On-Resistance vs. Gate-Source Voltage

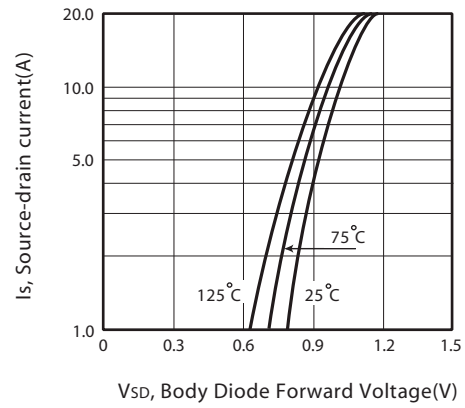

Figure 8. Body Diode Forward Voltage Variation with Source Current

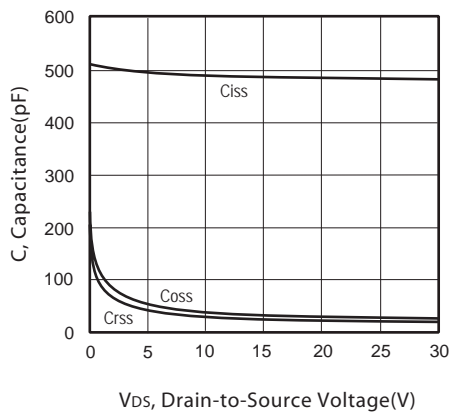

Figure 9. Capacitance

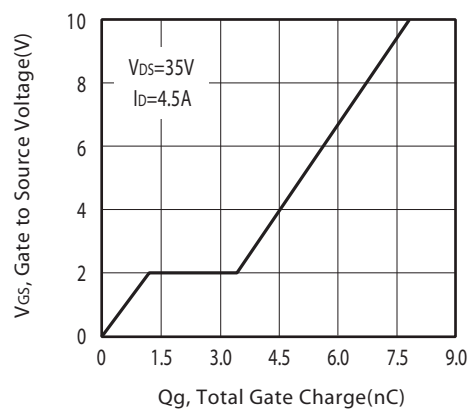

Figure 10. Gate Charge

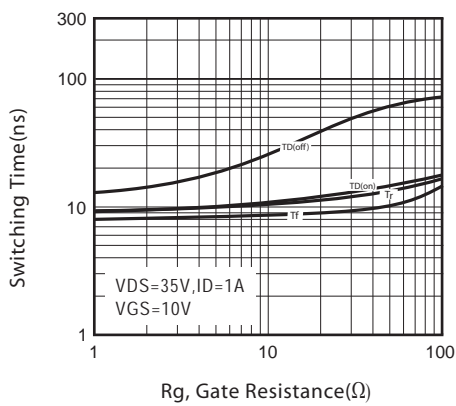

Figure 11. switching characteristics

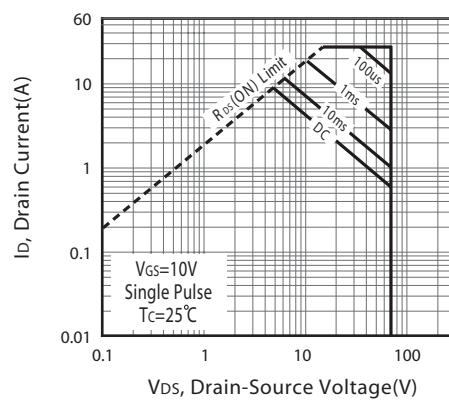
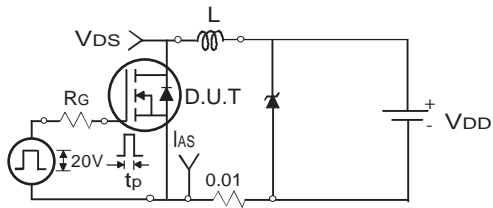

Figure 12. Maximum Safe Operating Area

Apr,10,2014

# STU03L07 STD03L07



Uncamped Inductive Test Circuit

Figure 13a.

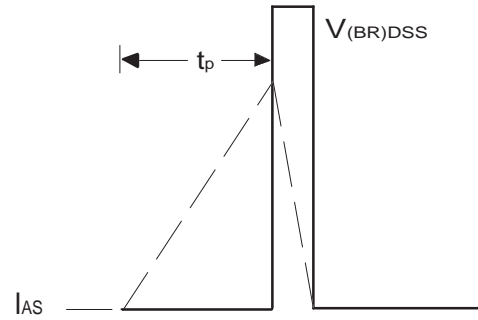

Unclamped Inductive Waveforms

Figure 13b.

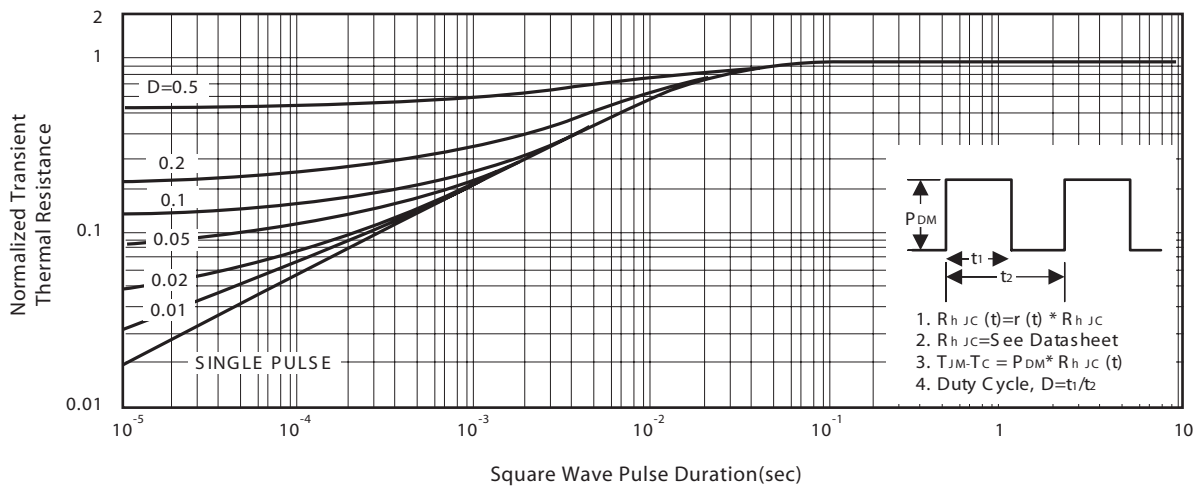
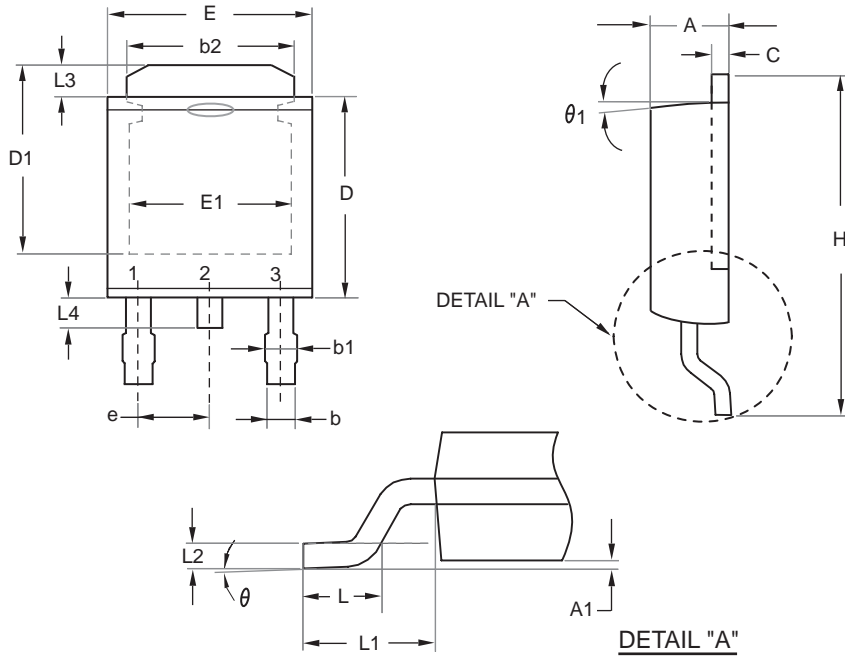

Figure 14. Normalized Thermal Transient Impedance Curve

# STU03L07 STD03L07

Ver 1.0

TO-252



SYMBOLS	MILLIMETERS		INCHES	
	MIN	MAX	MIN	MAX
A	2.100	2.500	0.083	0.098
A1	0.000	0.200	0.000	0.008
b	0.400	0.889	0.016	0.035
b1	0.770	1.140	0.030	0.045
b2	4.800	5.460	0.189	0.215
C	0.400	0.600	0.016	0.024
D	5.300	6.223	0.209	0.245
D1	4.900	5.515	0.193	0.217
E	6.300	6.731	0.248	0.265
E1	4.400	5.004	0.173	0.197
e	2.290 REF		0.090 BSC	
H	8.900	10.400	0.350	0.409
L	1.397	1.770	0.055	0.070
L1	2.743 REF.		0.108 REF.	
L2	0.508 REF.		0.020 REF.	
L3	0.890	1.700	0.035	0.067
L4	0.500	1.100	0.020	0.043
theta	0°	10°	0°	10°
theta1	7° REF.		7° REF.	

Apr,10,2014

# STU03L07

## STD03L07

Ver 1.0

### PACKAGE OUTLINE DIMENSIONS

TO-251

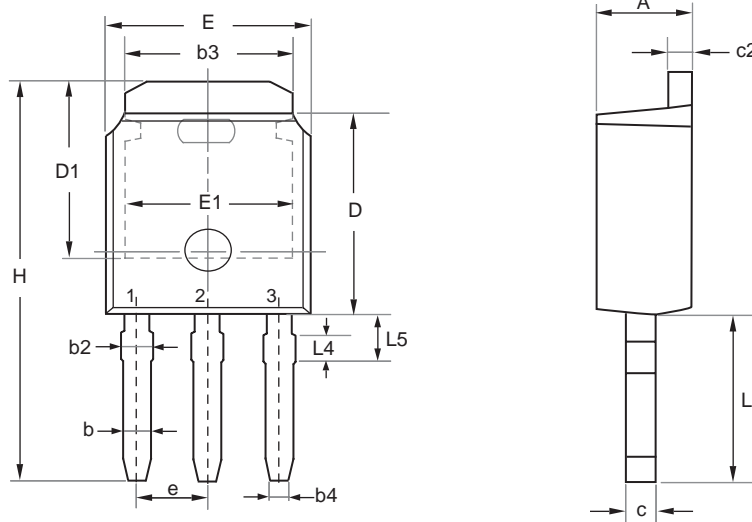

SYMBOL	MILLIMETERS		INCHES	
	MIN	MAX	MIN	MAX
E	6.400	6.731	0.252	0.265
L	3.980	4.280	0.157	0.169
L4	0.698 REF		0.027 REF	
L5	0.972	1.226	0.038	0.048
D	6.000	6.223	0.236	0.245
H	11.050	11.450	0.435	0.450
b	0.640	0.880	0.025	0.035
b2	0.770	1.140	0.030	0.045
b3	5.210	5.460	0.205	0.215
b4	0.450	0.550	0.018	0.022
e	2.286 BSC		0.090 BSC	
A	2.200	2.380	0.087	0.094
c	0.400	0.600	0.016	0.024
c2	0.400	0.600	0.016	0.024
D1	5.100	---	0.201	---
E1	4.400	---	0.173	---

Apr,10,2014

# STU03L07 STD03L07

Ver 1.0

## TO-251 Tube/TO-252 Tape and Reel Data

### TO-251 Tube

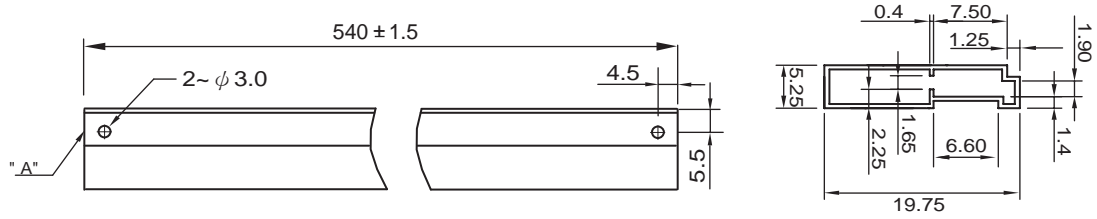

### TO-252 Carrier Tape

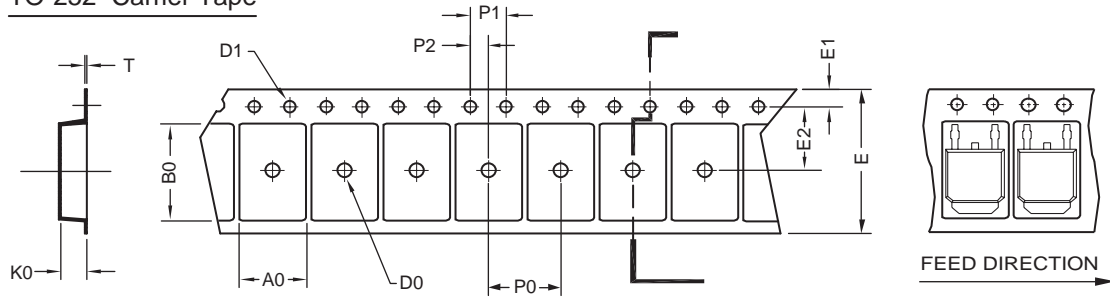

UNIT:mm

PACKAGE	A0	B0	K0	D0	D1	E	E1	E2	P0	P1	P2	T
TO-252 (16 mm)	6.96 ±0.1	10.49 ±0.1	2.79 ±0.1	φ 2	φ 1.5 +0.1 - 0	16.0 ±0.3	1.75 ±0.1	7.5 ±0.15	8.0 ±0.1	4.0 ±0.1	2.0 ±0.15	0.3 ±0.05

### TO-252 Reel

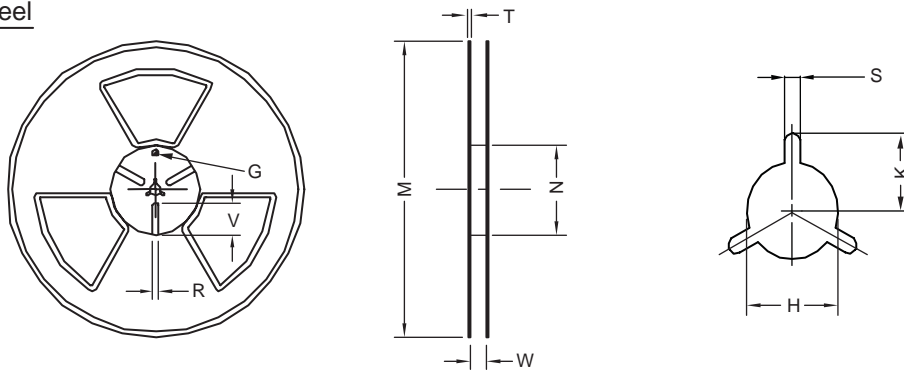

UNIT:mm

TAPE SIZE	REEL SIZE	M	N	W	T	H	K	S	G	R	V
16 mm	φ 330	φ 330 ± 0.5	φ 97 ± 1.0	17.0 + 1.5 - 0	2.2	φ 13.0 + 0.5 - 0.2	10.6	2.0 ±0.5	---	---	---

Apr,10,2014



# STU03L07 STD03L07

Ver 1.0

## TOP MARKING DEFINITION

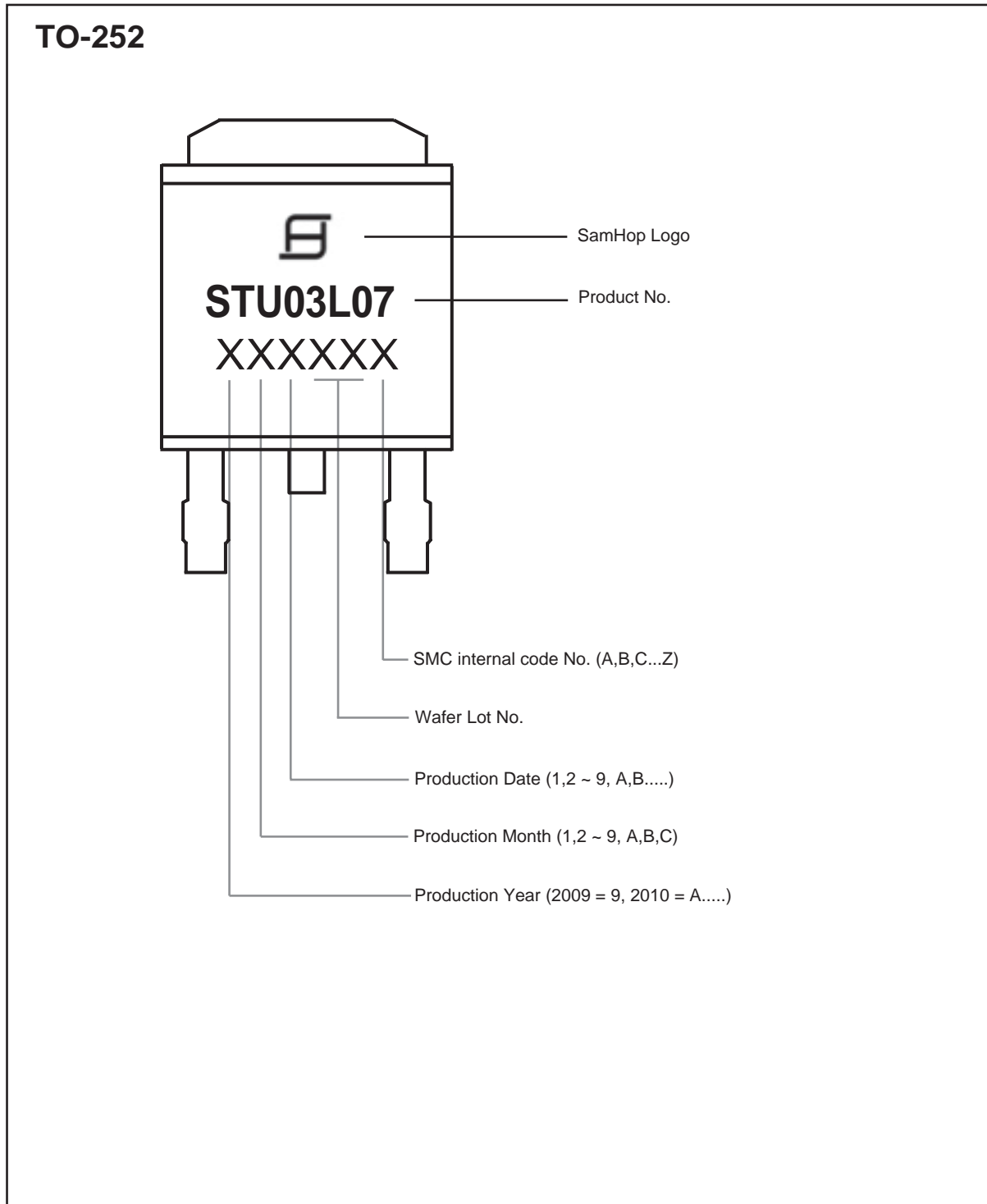

Apr,10,2014

# STU03L07 STD03L07

## TOP MARKING DEFINITION

