

# Service Manual

Color Television

**TC-14A12P**

**TC-20B12**

BR2L chassis



## Specifications

TELEVISION	TC-14A12P	TC-20B12
Power source	110/220 V AC, 60 Hz automatic switch	110/220 V AC, 60 Hz automatic switch
Consumption	55 W	69 W
Antenna input jack	75 W - VHF/UHF/Cable	75 W - VHF/UHF/Cable
Color systems	NTSC/PAL-N/AUTO/PAL-M	NTSC/PAL-N/AUTO/PAL-M
Tuning system	F.S.T.	F.S.T.
Channel capability	2 to 13 (VHF) 14 to 69 (UHF) 1 to 125 (Cable)	2 to 13 (VHF) 14 to 69 (UHF) 1 to 125 (Cable)
Picture tube (visual diagonal)	33 cm	48 cm
Audio system	3 W max (RMS)	3 W max (RMS)
Video input jack	1 (back of unit)	1 (back of unit)
Dimension (width, height, depth)	370 x 349 x 374 mm	502 x 455 x 471 mm
Weight	9,6 kg	17 kg

### Remote Control Transmitter:

Power Source	3V (2 AA type batteries)
Infrared Length	9500 A (Angstrom)
Number of Buttons	29 keys
Dimensions (W x H x D)	(54 x 27 x 135) mm

### Supplied Accessories:

- 1 Remote Control Transmitter
- 1 300Ω/75Ω Aerial Adaptor
- 2 "AA" type batteries
- 1 Internal antenna (for TC-14A12P only)

Specifications are subject to change without notice. Weight and dimensions shown are approximate.

**Panasonic**®

**⚠ WARNING**

This service information is designed for experienced repair technicians only and is not designed for use by the general public. It does not contain warnings or cautions to advise non-technician individuals of potential dangers in attempting to service a product. Products powered by electricity should be serviced or repaired only by experienced professional technicians. Any attempt to service or repair the product deal with in this service information by anyone could result in serious injury or death.

**Contents**

General Guidelines ..... 02

Operation Guide ..... 03

IC 601 - Pins and Functions ..... 15

IC601 and IC451 Voltage Table ..... 17

IC601 - Block Diagram ..... 18

General Summary ..... 19

**Service Adjustments and Calibrations**

Service Mode ..... 20

How to operate the DAC controls ..... 20

EQUIPMENT REQUIRED ..... 21

AGC RF CALIBRATION ..... 21

BUZZ (SOUND CIRCUIT) ..... 21

ANODE AND HEATER VOLTAGE CONFIRMATION ..... 21

PAL COLOR OUTPUT SIGNAL ADJUSTMENT ..... 21

NTSC SUB-TINT CALIBRATION ..... 22

PROTECTION CIRCUIT (SHUTDOWN) ..... 22

CONFIRMATION OF OPERATION ..... 22

WHITE QUALITY CALIBRATION ..... 22

VERTICAL DEFLECTION ..... 22

CALIBRATION AND CONFIRMATION ..... 22

CRT CUT OFF CALIBRATION ..... 23

WHITE BALANCE CALIBRATION ..... 23

SUB-BRIGHTNESS CALIBRATION ..... 23

FOCUS CALIBRATION ..... 23

COLOR PURITY ADJUSTMENT ..... 24

CONVERGENCE CALIBRATION ..... 24

EEPROM - Memory Maps ..... 25

Power Source Voltages ..... 25

Main Board Schematic Diagram ..... 26

CRT Board Schematic Diagram ..... 27

Main Board Conductor view ..... 28

Waveform ..... 32

Parts Location ..... 35

Packing and Accessories ..... 36

Replacement Mechanical Parts List ..... 36

Replacement Electrical Parts List ..... 37

**General Guidelines**

An Isolation Transformer should always be used during the servicing of a receiver whose chassis is not isolated from the AC power line. Use a transformer of adequate power rating as this protects the technician from accidents resulting in personal injury from electrical shocks. It will also protect the Receiver from being damaged by accidental shorting that may occur during servicing. When servicing, observe the original lead dress, especially in the high voltage circuit. Replace all damaged parts (also parts that show signs of overheating.)

Always Replace Protective Devices, such as fishpaper, isolation resistors and capacitors, and shields after servicing the Receiver. Use only manufacturer's recommended rating for fuses, circuit breakers, etc.

High potentials are present when this Receiver is operating. Operation of the Receiver without the rear cover introduces danger from electrical shock. Servicing should not be performed by anyone who is not thoroughly familiar with the necessary precautions when servicing high-voltage equipment. Extreme care should be practiced when Handling the Picture Tube. Rough handling may cause it to implode due to atmospheric pressure (14.7 lbs per sq. in). Do not sick or scratch the glass or subject it to any undue pressure. When handling, use safety goggles and heavy gloves for protection. Discharge the picture tube by shorting the anode to chassis ground (not to the cabinet or to other mounting hardware). When discharging, connect cold ground (i.e. dag ground lead) to the anode with a well insulated wire or use a grounding probe.

Avoid prolonged exposure at close range to unshielded areas of the picture tube to prevent exposure to X-ray radiation. The Test Picture Tube used for servicing the chassis at the bench should incorporate safety glass and magnetic shielding. The safety glass provides shieldinf for the tube viewing area against X-ray radiation as well as implosion. The magnetic shield limits X-ray radiation around the bell of the picture tube in addition to restricting magnetic effects. When using a picture tube test jig for service, ensure that the jig is capable of handling 31kV without causing X-ray radiation.

Before returning a serviced receiver to the owner, the service technician must thoroughly test the unit to ensure that is completely safe to operator. Do not use a line isolation transformer when testing.

## Location of Controls (TC-20B12)

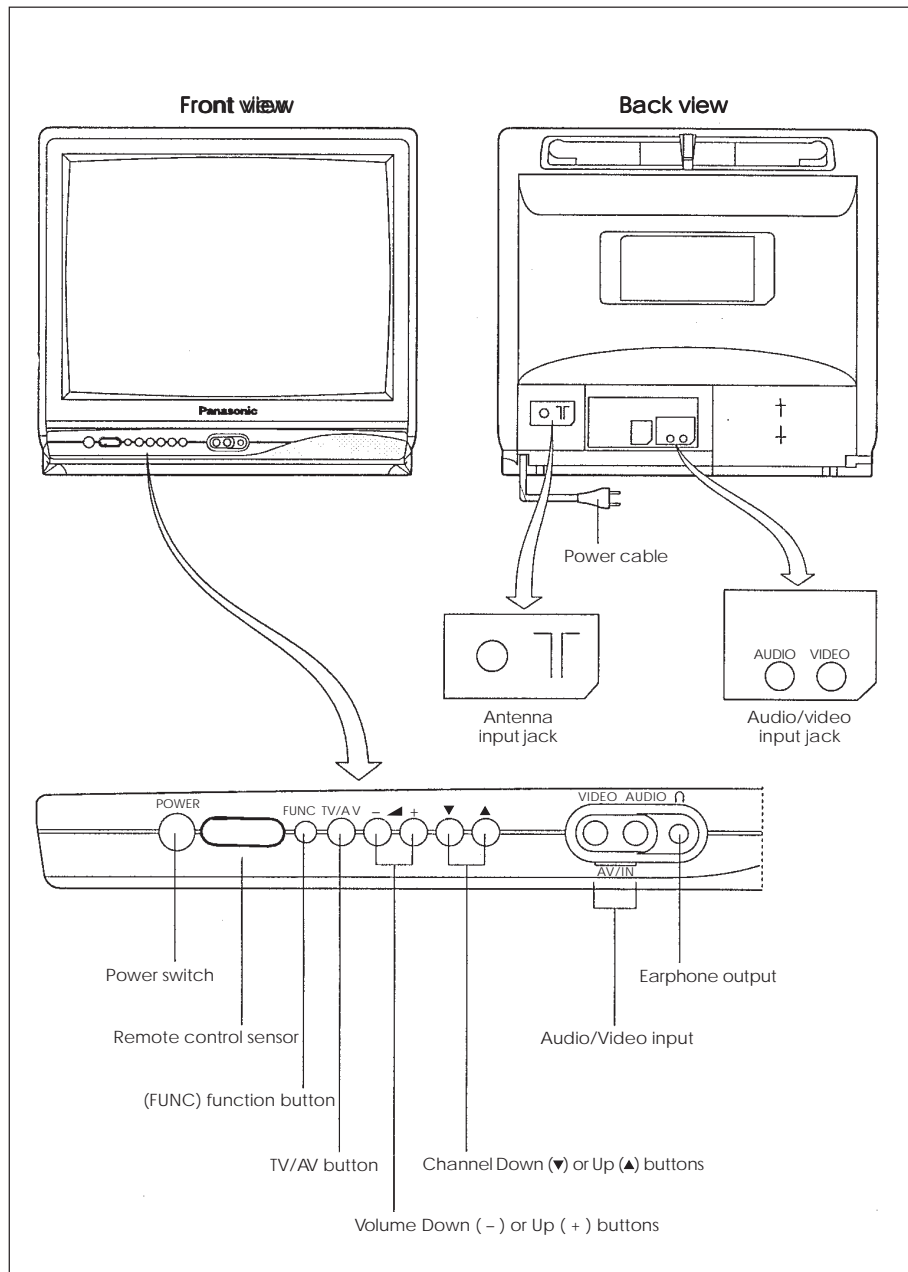

## Location of Controls (TC-14A12P)

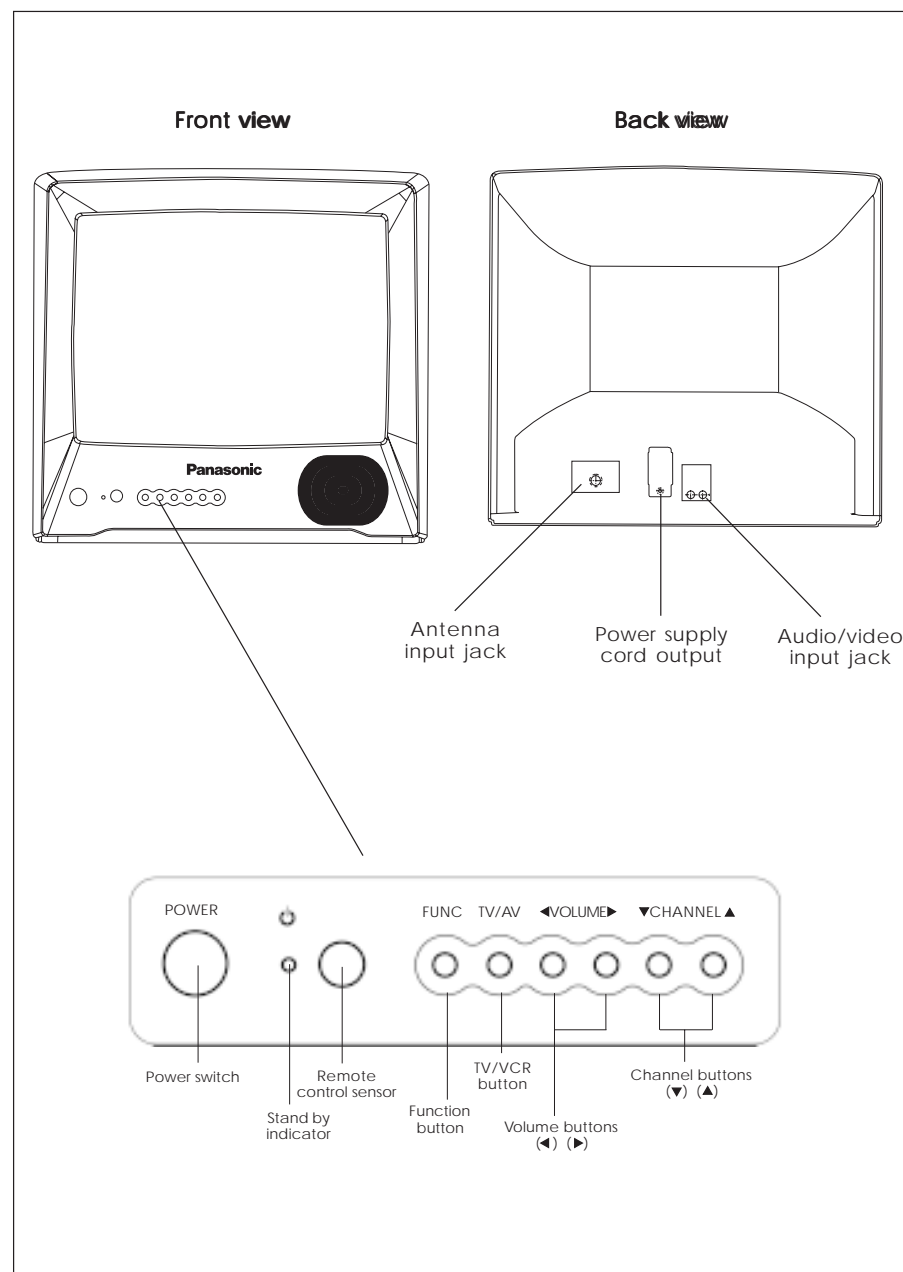

# Location of Controls

## REMOTE CONTROL

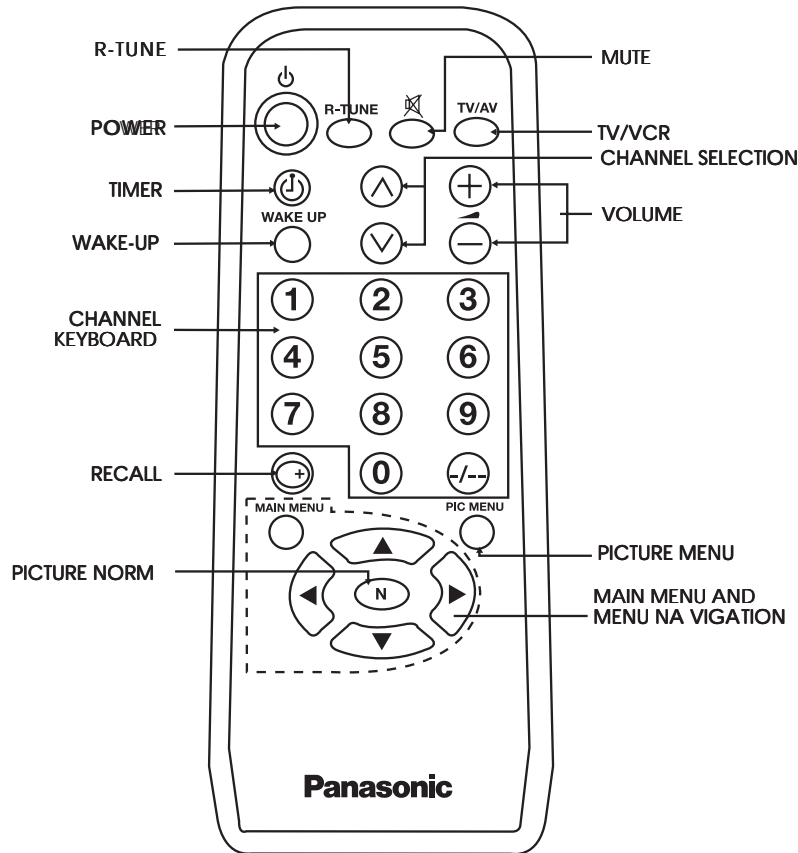

# Remote Control

## Installing the Batteries

1. Remove the battery compartment cover from the back of the remote control, by pressing the lock down and pulling the cover out.
2. Install the batteries in the compartment (polarities (+) and (-) must be correct).
3. To replace, fit both cover lugs into the compartment slots and press the lock to close.

1



2

Two "AA" batteries

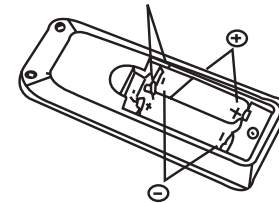

3

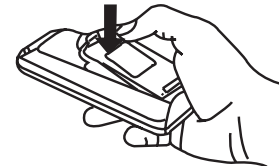

## Battery replacement precautions

1. Batteries must be replaced as a pair.
2. Do not combine a used battery with a new one.
3. Do not mix battery types (example: "zinc carbon" with "alkaline").
4. Do not attempt to charge, short-circuit, disassemble, heat, or burn used batteries.
5. Remove the batteries if the remote control transmitter will not be used for a long period of time.

### Note:

This remote control transmitter uses two "R6" (AA) batteries.



Dispose of the batteries in the domestic trash.

## Installation

### Outdoor Antenna Connection

For proper sound and picture reception, an outdoor antenna, a proper cable (75 ohms coaxial cable or 300 ohms twin cable) and an appropriate terminal (75 ohms) are required.

Your local service representative can help you obtain the adequate system and accessories for antennas.

Installation procedures different from those presented here or any modification of existing systems or required accessories, as well as all expenses involved in such actions, shall be considered as the owner's sole responsibility.

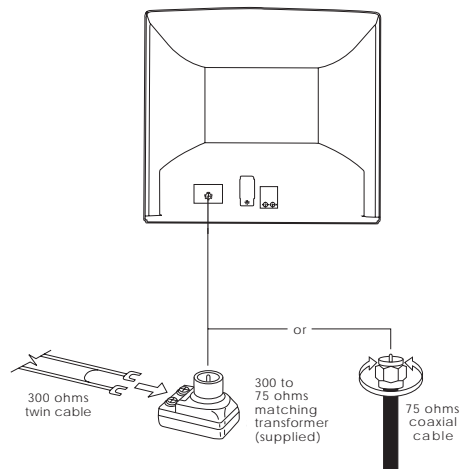

## Connection

### VCR

To connect a VCR, proceed as follows:

1. Connect the VCR audio and video output terminals to the audio and video input jacks, located on the back of the unit.
2. Press the TV/AV button to select the AV mode. Turn the VCR ON.
3. Press the button again to return to the TV mode.

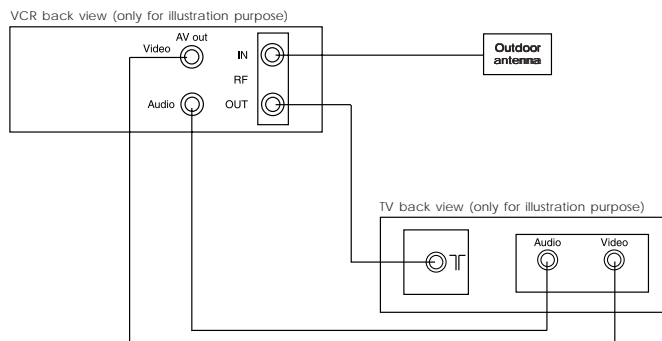

### NOTE:

To use the video game, connect the video game audio and video output terminals to the audio and video input jacks on the TV.

Connection cables are not supplied.

## Operation of TV Controls

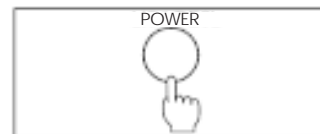

### 1. Power Switch

Press this switch to turn the unit ON. Press again to turn it OFF.

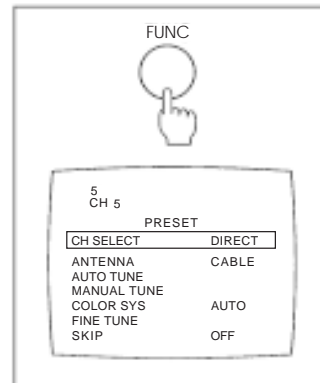

### 2. Function Button

Press this button to access the PRESET menu.

Press it continuously to select a menu function, as shown in the illustration.

To exit the PRESET menu, press the function button continuously.

(For more details, refer to PRESET menu.)

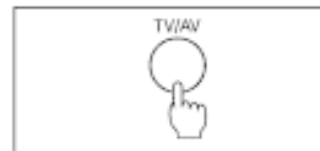

### 3. TV/AV Button

Press this button to select the desired input.

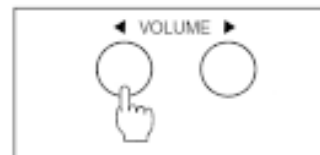

### 4. Volume Buttons

Press the left or right button for the desired listening level.

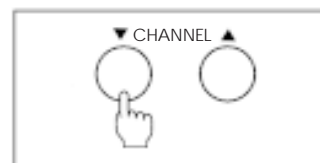

### 5. Channel Buttons

Press these buttons to select the desired channel.

# General Operation

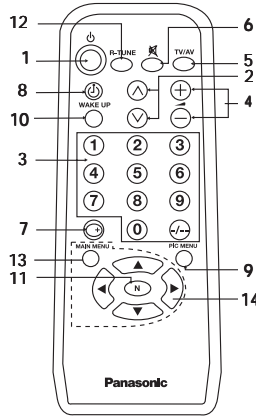

## 1. Power Button (Stand by mode)

To turn the unit ON with this button, the power switch on the TV panel must be ON. To turn it OFF, press the button again (stand by mode). If the unit was turned OFF with the remote control (stand by mode), it is also possible to turn it ON by pressing either channel button.

### Note:

- Leaving the unit in the stand by mode will not cause any damages and energy consumption is minimum.
- It is recommended to turn the unit OFF periodically by using the TV power switch. When the unit is turned ON again after 30 minutes, the demagnetization circuit of picture tube is activated.
- If the unit is to be left unused for a long period of time, turn it OFF by using the TV power switch, disconnect the antenna and unplug the AC power supply cord.

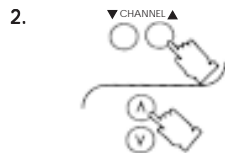

## 2. Channel Buttons

Press these buttons to select the programmed channels.

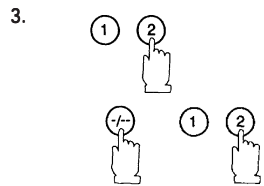
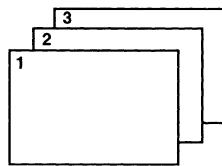

## 3. Channel Keyboard for Direct Selection (Memory Position)

Press these buttons to select the desired channel.

To select channels with two figures, press the  $\uparrow/\downarrow$  button and then press the buttons corresponding to the channel number.

Example: For channel 12, press  $\uparrow/\downarrow$  1 2

To select channels with three figures, press the buttons corresponding to the channel number.

**Note:** For selecting channels with three figures, the **CH SELECT** function must be in **DIRECT** mode, and the **ANTENNA** mode in **CABLE** (Refer to Tuning Procedures - Channel Selection and Antenna Mode).

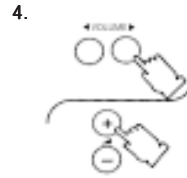

## 4. Volume Buttons (+, -)

Press these buttons to adjust the listening level.

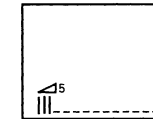

### Note:

A numerical and graphic indication will be displayed. The numerical indication ranges from zero (no sound) to 63 (maximum level).

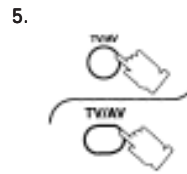

## 5. TV/AV Button

Press this button to select TV or video input.

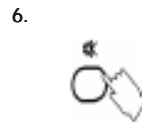

## 6. Mute Button (Mute icon)

Press this button to quickly reduce sound level. Press it again to restore sound. The mute indicator (red) will be displayed.

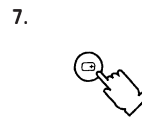

## 7. Recall Button (Recall icon)

Press this button to review the selected system. Press it again to disable this function.



## 8. Timer Button (Timer icon)

This TV can be programmed to turn OFF after a certain period of time.

Press this button repeatedly for automatic turn OFF after 30, 60 or 90 minutes, as desired.

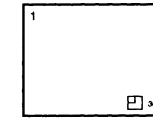
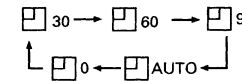

Time indication will flash to indicate the last three remaining minutes prior to turn OFF.

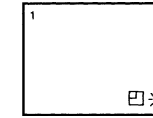

### Note:

- When AUTO is selected, the unit will turn OFF automatically (stand by mode) 5 minutes after the TV station broadcast is finished.
- This function (AUTO) will not operate when the VCR/V mode is selected.

To cancel the **TIMER** (Timer icon), select "0" (zero) by pressing the **TIMER** button, or turn the unit OFF by using the power switch on the TV panel.

## General Operation

9.

PIC MENU



### PICTURE MENU Button

Press this button to select the picture menu sequentially, as shown below:

On screen	Function
DYNAMIC	For bright places. This setting selects a higher level of brightness and contrast.
STANDARD	For places with normal levels of luminosity. This setting selects a normal level of brightness and contrast.
SOFT	For dark places. This setting selects a reduced level of brightness and contrast.

10.

WAKE UP



### WAKE-UP Button

1. Press the WAKE-UP button.
2. Press the menu navigation buttons (◀ ▶) to set the WAKE-UP feature.

The time can be set in increments of 10 minutes.

3. Set the time and turn the unit OFF by using the remote control (stand by mode).

If the unit is turned OFF with the remote control (stand by mode) and the WAKE-UP feature set, the led on the TV panel will flash.

The unit will be turned ON automatically at the selected time.

#### Note:

- The WAKE-UP feature can be programmed up to 12 hours.
- When the unit is tuned ON by the WAKE-UP feature, the TIMER will be set automatically to turn it OFF in 90 minutes. Press any button to cancel the TIMER.

4. To cancel the WAKE-UP feature:

- 4.1 Turn the unit OFF by using the power switch on the TV panel.
- 4.2 Press the menu navigation buttons (◀ ▶) during the WAKE-UP indication until OFF is displayed.
- 4.3 Press the N (Picture nom) button while the WAKE-UP mode is displayed.

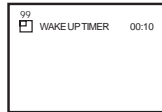
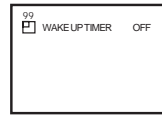

11.



### N (Picture nom) Button

Press this button to reset picture setting levels (color, brightness, contrast, etc.) or sound (tone, A/L\*), back to the factory preset level.

#### Note:

- For this function to operate, picture and sound setting menu must be activated.

\* Refer to page 22.

## General Operation

12.



### R-TUNE Button

Press this button to instantly switch between the last two channels selected.

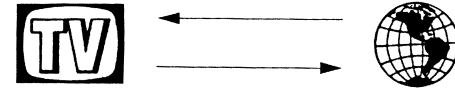

13.

MAIN MENU



### MAIN MENU Button

Press this button to access the icon menu on the screen.

14.



### Menu navigation buttons

# Main Menu List

When the MAIN MENU button is pressed, the icon menu is displayed. This gives access to picture, sound, function, language and setup icons.

Press					
Select					
Icon					
Screen indication	PICTURE	SOUND	FEATURES	IDIOMA PORTUGUÉS ESPAÑOL ENGLISH	PRESET
Press	▽	▽	▽	▽	▽
Screen indication (example)	MENU DYNAMIC 32 COLOR 32 NTSC-TINT 32 BRIGHT 63 CONTRAST 32 SHARPNESS COLOR TEMP. STD	TONE LOW AVL ON	BLUE BACK ON CH COLOR SET STD CHILD LOCK OFF VCR/GAME OFF MODE OFF ON MUTE NO	IDIOMA PORTUGUÉS ESPAÑOL ENGLISH	5 CH 5 PRESET CH SELECT DIRECT ANTENNA TV AUTO TUNE MANUAL TUNE COLOR SYS AUTO FINE TUNE SKIP OFF
	MENU DYNAMIC 32 COLOR 32 NTSC-TINT 32 BRIGHT 63 CONTRAST 32 SHARPNESS COLOR TEMP. STD	TONE LOW AVL ON	BLUE BACK ON CH COLOR SET STD CHILD LOCK OFF VCR/GAME OFF MODE OFF ON MUTE NO	LANGUAGE PORTUGUÉS ESPAÑOL ENGLISH	5 CH 5 PRESET CH SELECT DIRECT ANTENNA TV AUTO TUNE MANUAL TUNE COLOR SYS AUTO FINE TUNE SKIP OFF
	MENU DYNAMIC 32 COLOR 32 NTSC-TINT 32 BRIGHT 63 CONTRAST 32 SHARPNESS COLOR TEMP. STD	TONE LOW AVL ON	BLUE BACK ON CH COLOR SET STD CHILD LOCK OFF VCR/GAME OFF MODE OFF ON MUTE NO	LANGUAGE PORTUGUÉS ESPAÑOL ENGLISH	5 CH 5 PRESET CH SELECT DIRECT ANTENNA TV AUTO TUNE MANUAL TUNE COLOR SYS AUTO FINE TUNE SKIP OFF
	MENU DYNAMIC 32 COLOR 32 NTSC-TINT 32 BRIGHT 63 CONTRAST 32 SHARPNESS COLOR TEMP. STD	TONE LOW AVL ON	BLUE BACK ON CH COLOR SET STD CHILD LOCK OFF VCR/GAME OFF MODE OFF ON MUTE NO	LANGUAGE PORTUGUÉS ESPAÑOL ENGLISH	5 CH 5 PRESET CH SELECT DIRECT ANTENNA TV AUTO TUNE MANUAL TUNE COLOR SYS AUTO FINE TUNE SKIP OFF
	MENU DYNAMIC 32 COLOR 32 NTSC-TINT 32 BRIGHT 63 CONTRAST 32 SHARPNESS COLOR TEMP. STD	TONE LOW AVL ON	BLUE BACK ON CH COLOR SET STD CHILD LOCK OFF VCR/GAME OFF MODE OFF ON MUTE NO	LANGUAGE PORTUGUÉS ESPAÑOL ENGLISH	5 CH 5 PRESET CH SELECT DIRECT ANTENNA TV AUTO TUNE MANUAL TUNE COLOR SYS AUTO FINE TUNE SKIP OFF
	MENU DYNAMIC 32 COLOR 32 NTSC-TINT 32 BRIGHT 63 CONTRAST 32 SHARPNESS COLOR TEMP. STD	TONE LOW AVL ON	BLUE BACK ON CH COLOR SET STD CHILD LOCK OFF VCR/GAME OFF MODE OFF ON MUTE NO	LANGUAGE PORTUGUÉS ESPAÑOL ENGLISH	5 CH 5 PRESET CH SELECT DIRECT ANTENNA TV AUTO TUNE MANUAL TUNE COLOR SYS AUTO FINE TUNE SKIP OFF
	MENU DYNAMIC 32 COLOR 32 NTSC-TINT 32 BRIGHT 63 CONTRAST 32 SHARPNESS COLOR TEMP. STD	TONE LOW AVL ON	BLUE BACK ON CH COLOR SET STD CHILD LOCK OFF VCR/GAME OFF MODE OFF ON MUTE NO	LANGUAGE PORTUGUÉS ESPAÑOL ENGLISH	5 CH 5 PRESET CH SELECT DIRECT ANTENNA TV AUTO TUNE MANUAL TUNE COLOR SYS AUTO FINE TUNE SKIP OFF

# Tuning Procedures

## Channel Selection

Select the most familiar channel visualization pattern.

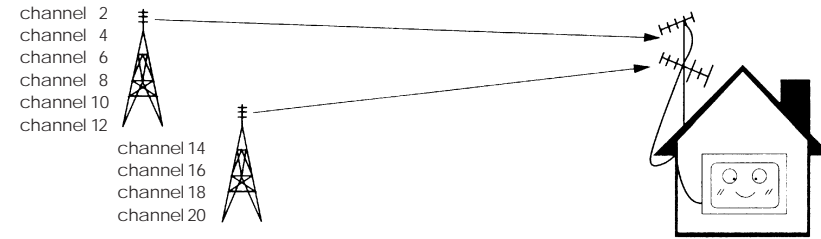

Program number	Channel exhibition	Selected channel
1	2	2
24		4
36		6
48		8
51	0	10
61	2	12
71	4	14
81	6	16
91	8	18
10	20	20

### Selection of channels by position

When the channel selection is in POSITION mode, the tuned channels in AUTO TUNE mode, will be memorized according to the program number

Program number	Channel exhibition	Selected channel
1	-	-
22		2
3-		-
44		4
5-		-
66		6
7-		-
88		8
9-		-
10	10	10

### Direct Channel Selection

When the channel selection is in DIRECT mode, the tuned channels in AUTO TUNE mode, will be memorized according to the TV station number



# Tuning Procedures

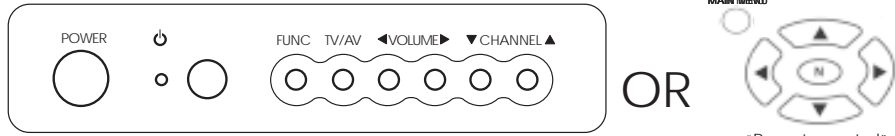

## Channel Selection Mode

1. Press the FUNC (Function) button and select CH SELECT (Channel selection) in the PRESET menu.

5	CH 5	PRESET
CH SELECT	POSITION	
ANTENNA	CABLE	
AUTO TUNE		
MANUAL TUNE		
COLOR SYS	AUTO	
FINE TUNE		
SKP	OFF	

CH SELECT (Channel selection) screen

Press the MAIN MENU button and by pressing the navigation buttons, select PRESET and then CH SELECT (Channel selection).

2. After selecting CH SELECT (Channel selection), press the VOLUME button to select POSITION or DIRECT.

Press the navigation button (◀▶) to select POSITION or DIRECT.

5	CH 5	PRESET
CH SELECT	POSITION	
ANTENNA	CABLE	
AUTO TUNE		
MANUAL TUNE		
COLOR SYS	AUTO	
FINE TUNE		
SKP	OFF	

**Note:**

- The POSITION mode allows you to memorize 100 positions (0 ~ 99).
- The DIRECT mode allows you to memorize 125 positions (1 ~ 125).

3. Press the FUNC (Function) button until the setup menu is no longer displayed.

Press the MAIN MENU button until the setup menu is no longer displayed.

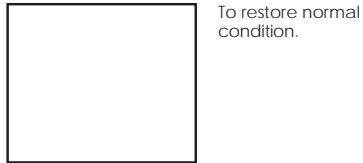

# Tuning Procedures

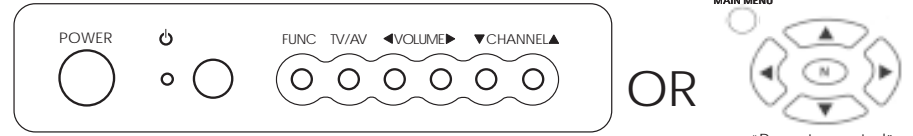

## ANTENNA Mode

1. Press the FUNC (Function) button and select ANTENNA in the PRESET menu.

5	CH 5	PRESET
CH SELECT	DIRECT	
ANTENNA	TV	
AUTO TUNE		
MANUAL TUNE		
COLOR SYS	AUTO	
FINE TUNE		
SKP	OFF	

ANTENNA screen

Press the MAIN MENU button and by pressing the navigation buttons, select PRESET and then ANTENNA.

2. Press the VOLUME button to select TV or CABLE.

Press the navigation button (◀▶) to select TV or CABLE.

5	CH 5	PRESET
CH SELECT	DIRECT	
ANTENNA	TV	
AUTO TUNE		
MANUAL TUNE		
COLOR SYS	AUTO	
FINE TUNE		
SKP	OFF	

The antenna mode indicator will change as shown.

TV  
↑  
↓  
CABLE

3. Press the FUNC (Function) button until the setup menu is no longer displayed.

Press the MAIN MENU button until the setup menu is no longer displayed.

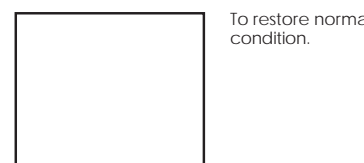

## Channel Capability

ANTENNA MODE	CHANNEL CAPABILITY
TV	VHF: 2 ~ 13, UHF: 14 ~ 69
CABLE	CABLE: 1 ~ 125

# Tuning Procedures

## Auto Tuning Procedure

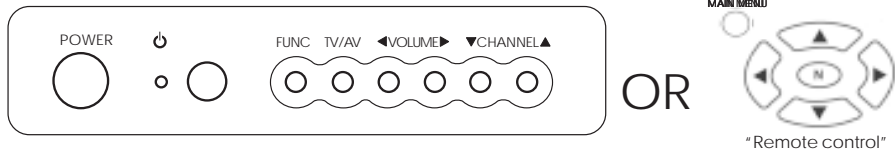

1. **FUNC** Press the FUNC (Function) button and select AUTO TUNE in the PRESET menu. **AUTO TUNE (Auto tuning) screen**

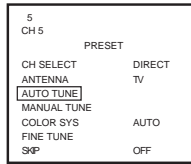

**MAIN/MENU** Press the MAIN MENU button and by pressing the navigation buttons, select PRESET and then AUTO TUNE (Auto tuning).

2. **VOLUME** Press the VOLUME button to start auto tuning. **Beginning of channel searching.**

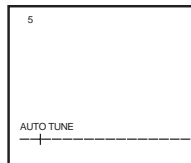

Press the navigation button (◀▶) to start auto tuning.

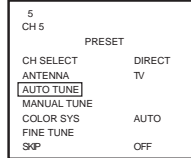

Optimum tuning position is memorized automatically.

3. **FUNC** Press the FUNC (Function) button until the setup menu is no longer displayed. **To restore normal condition.**

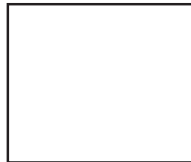

**MAIN/MENU** Press the MAIN MENU button until the setup menu is no longer displayed.



# Tuning Procedures

## Manual Tuning Procedure

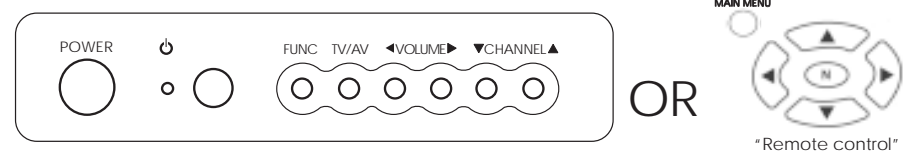

1. **FUNC** Press the FUNC (Function) button and select MANUAL TUNE (Manual tuning) in the PRESET menu. **MANUAL TUNE (Manual tuning) screen**

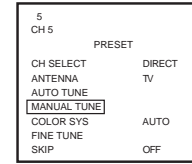

**MAIN/MENU** Press the MAIN MENU button and by pressing the navigation buttons, select PRESET and then MANUAL TUNE (Manual tuning).

2. **CHANNEL** Press the CHANNEL button (▼/▲) to select the position you want to memorize. **Select the desired channel.**

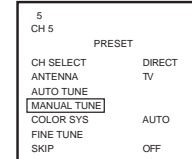
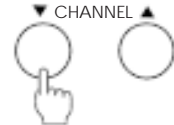

3. **VOLUME** Press the VOLUME button to start manual tuning. Volume (▶) searches channels in increasing order. Volume (◀) searches channels in decreasing order. **Beginning of channel searching.**

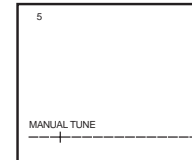
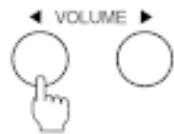

Press the right or left navigation button to start manual tuning. Button (▶) searches channels in increasing order. Button (◀) searches channels in decreasing order. **Optimum tuning position is memorized automatically.**

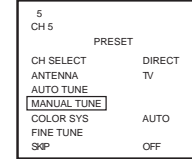

4. **FUNC** Press the FUNC (Function) button until the setup menu is no longer displayed. **To restore normal condition.**



**MAIN/MENU** Press the MAIN MENU button until the setup menu is no longer displayed.



# Tuning Procedures

## Fine Tuning Mode

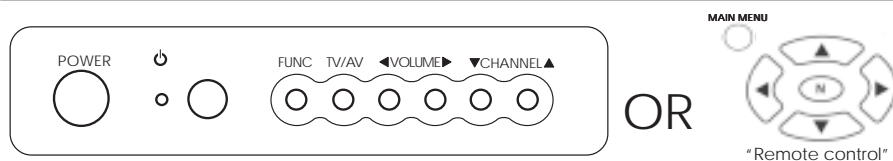

In normal reception conditions, this feature should not be used. However, in areas where reception is poor or if constant interference occurs, it may improve picture and sound quality.

- 

Press the CHANNEL button to select a channel.

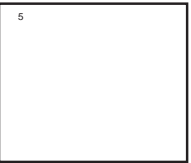

Select the desired channel.
- 

Press the FUNC (Function) button and select FINE TUNE (Fine tuning) in the PRESET menu.

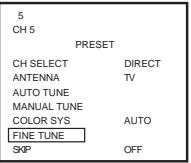

FINE TUNE (Fine tuning) screen

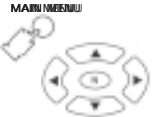

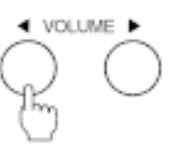
Press the MAIN MENU button and by pressing the navigation buttons, select PRESET and then FINE TUNE (Fine tuning).
- 

Press the VOLUME button and adjust to improve picture quality.

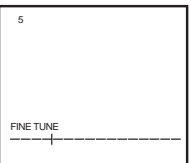

Beginning of fine tuning.



Press the navigation (◀/▶) button and adjust to improve picture quality.

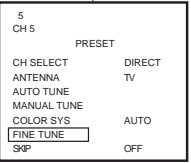

AFC feature is disabled. The "■" indicator is displayed on the left of channel number.
- 

Press the FUNC (Function) button until the setup menu is no longer displayed.



To restore normal condition.





Press the MAIN MENU button until the setup menu is no longer displayed.

**Note:**  
To cancel fine tuning, perform manual tuning procedures for the desired channel.

# Tuning Procedures

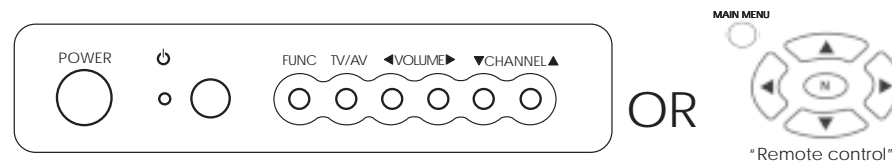
## Channel Skip Mode



- 

Press the FUNC (Function) button and select SKIP in the PRESET menu.

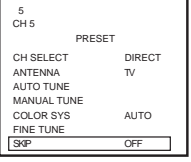



SKIP screen

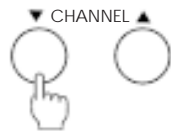

Press the MAIN MENU button and by pressing the navigation buttons, select PRESET and then SKIP
- 

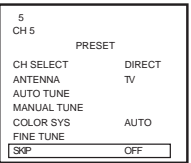
Press the CHANNEL button (▼/▲) to select the channel you want to skip.

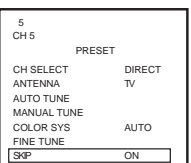

- 

Press the VOLUME button and select ON.



OFF will change to ON.



Press the navigation button (◀/▶) and select ON.
- 

Press the FUNC (Function) button until the setup menu is no longer displayed.



To restore normal condition.



Press the MAIN MENU button until the setup menu is no longer displayed.

**Note:**  
When SKIP is ON, the channel cannot be selected by using the channel buttons.

# Tuning Procedures

## Color System Mode

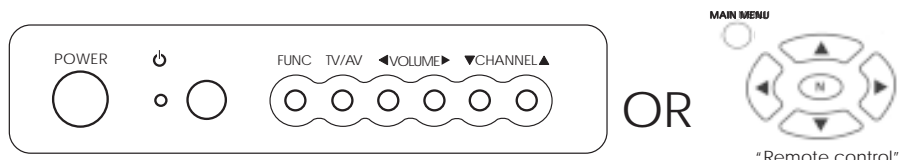

1. **FUNC** Press the FUNC (Function) button and select COLOR SYS in the PRESET menu. **COLOR SYS screen**

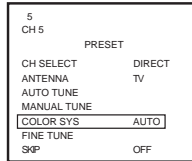

**MAIN/MENU** Press the MAIN MENU button and by pressing the navigation buttons, select PRESET and then COLOR SYS.



2. **VOLUME** Press the VOLUME button repeatedly to select the desired system. The color system will change as shown:

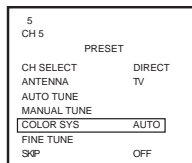

Press the navigation button (◀ ▶) repeatedly to select the desired system.

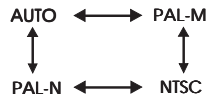

3. **FUNC** Press the FUNC (Function) button until the setup menu is no longer displayed. To restore normal condition.



**MAIN/MENU** Press the MAIN MENU button until the setup menu is no longer displayed.



# Supplementary Remote Control Operations

## Picture Menu

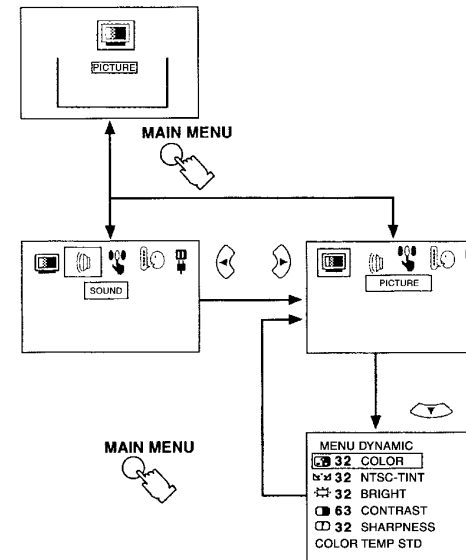

### Picture menu

To select functions vertically or horizontally, press the navigation buttons.

Press	Item	Effect	Indicator
Select	COLOR	Decrease Increase	
Select	NTSC-TINT	Greenish Reddish	
Select	BRIGHT	Darker Brighter	
Select	CONTRAST	Decrease Increase	
Select	SHARPNESS	Decrease Increase	
Select	COLOR TEMP . STD		

### Important Note

If picture menu is active and the N (Picture norm) button is pressed, picture settings will be reset to factory setup levels.

# Supplementary Remote Control Operations

## Sound Menu

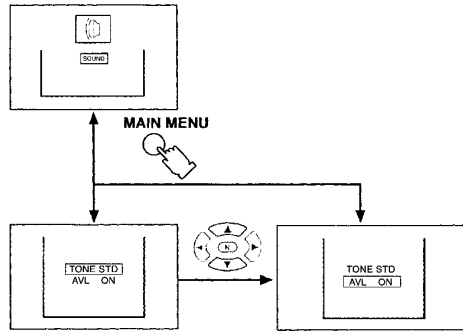

### Sound Menu

To select functions vertically or horizontally, press the navigation buttons.

Press	Item	Effect	Indicator
Select ◀▶	TONE STD	Decrease • Increase ◀▶	STD ↔ HIGH ↕ LOW ↔
Select ◀▶	AVL ON	ON ↔ OFF ◀▶	AVL ON

### AVL ( Automatic V olume Levelling )

This feature restricts sound volume to a preset level, when broadcast sound levels differ between programs and commercials.

### Important Note

If sound menu is active and the N (Picture norm) button is pressed, sound settings will be reset to factory setup levels.

# Supplementary Remote Control Operations

## Features Menu

To select functions vertically or horizontally, press the navigation buttons

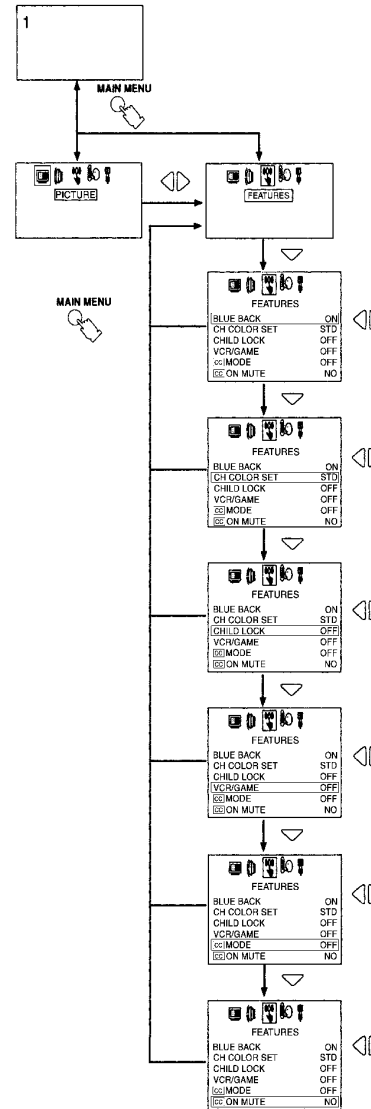

### BLUE BACK (Blue screen)

When this feature is activated, the screen will turn blue if there is no input of a TV station signal, when the signal is weak, or when the picture is excessively snowy. To avoid excessive noise, sound level is reduced to zero.

Press the navigation button (◀▶) to select ON ↔ OFF.

#### Note:

This feature should be disabled by selecting OFF in the following situations:

1. When the program signal is weak or when the picture is excessively snowy.
2. When reproducing a video tape in FF or REW mode.

### CH COLOR SET (Individual color channel setting)

Color intensity may vary among TV stations. This feature allows you to individually adjust color settings for each station. Press the navigation button (◀▶) to adjust as follows:



### CHILD LOCK

Press the navigation button (◀▶) to select ON ↔ OFF.

#### Note:

1. When the channel is locked, the screen turns blue and sound level is reduced to zero.
2. When the FUNC (Function) button is pressed, the indication CHILD LOCK ON will be displayed. No setting function can be accessed.
3. When the unit is turned ON while in a locked channel, the indication CHILD LOCK ON will be displayed to remind you that this feature is activated.

### VCR/GAME

Press the navigation button (◀▶) to select ON ↔ OFF.

When this feature is ON, brightness and contrast are set to optimum picture levels.

### CC MODE (Mode/Closed Caption)

Press the navigation button (◀▶) to select an option as shown below:

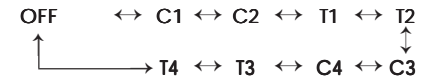

# Supplementary Remote Control Operations

## CC ON MUTE (Mute/Closed Caption)

This feature will function only when:

1. Mode/CC feature is OFF
2. The MUTE button (M) is pressed on the remote control.

Press the navigation button (◀/▶) to select an option as shown below:

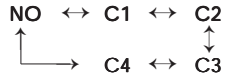

FEATURES		
BLUE BACK		ON
CH COLOR SET		STD
CHILD LOCK		OFF
VCR/GAME		OFF
CC MODE		OFF
CC ON MUTE		NO

## Language

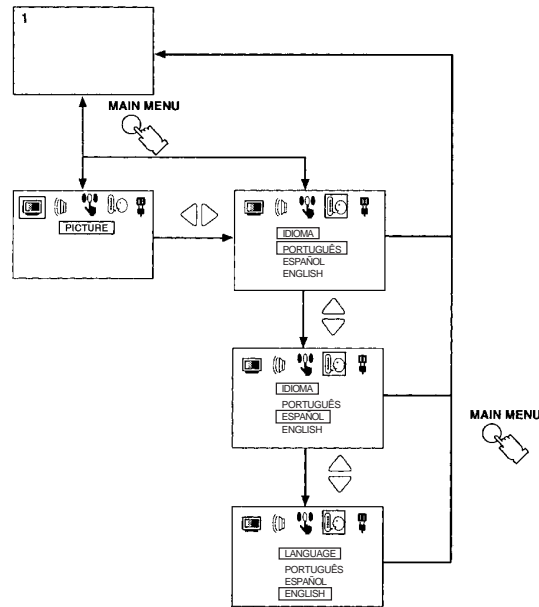

To select functions vertically or horizontally, press the navigation buttons.

## Hotel Mode

This feature is very useful in hotels or when the owner does not want other people to change setting levels. When activated, only CHANNEL, VOLUME, PICTURE MENU, RECALL, MUTE, TV/M buttons will operate.

To activate:

1. Adjust sound level.
2. Press the TIMER button on the remote control and set it to 30 minutes.
3. Press and hold the RECALL button.
4. Press the CHANNEL (▲) button on the TV panel.

To exit Hotel mode:

Press the VOLUME (◀) button on the TV panel and the TIMER button on the remote control simultaneously.

# Troubleshooting Chart

Before you call for service, determine the symptoms and make a few simple checks, as shown below.

SIGNALS		Check
Picture	Sound	
Snowy picture	Noisy sound	Antenna location and/or connection
Multiple image	Normal sound	Antenna location and/or connection
Interference	Noisy sound	Electrical appliances, lights, cars and motorcycles
Normal picture	No sound	Volume (check if mute control is activated on the remote control)
No picture	No sound	Check that the AC power cord is plugged into the AC outlet. Unit has not been turned ON. Brightness/contrast and audio control settings (Check by pressing the power switch.)
No color	Normal sound	Color control settings
No video	Low sound	Perform channel tuning procedure again.
Colored blotches	Normal sound	Unit was relocated while it was ON.
No color	Noisy sound	Improper color system

## ■ IC601 (TDA9381PS/N2/3) - Pins and Functions

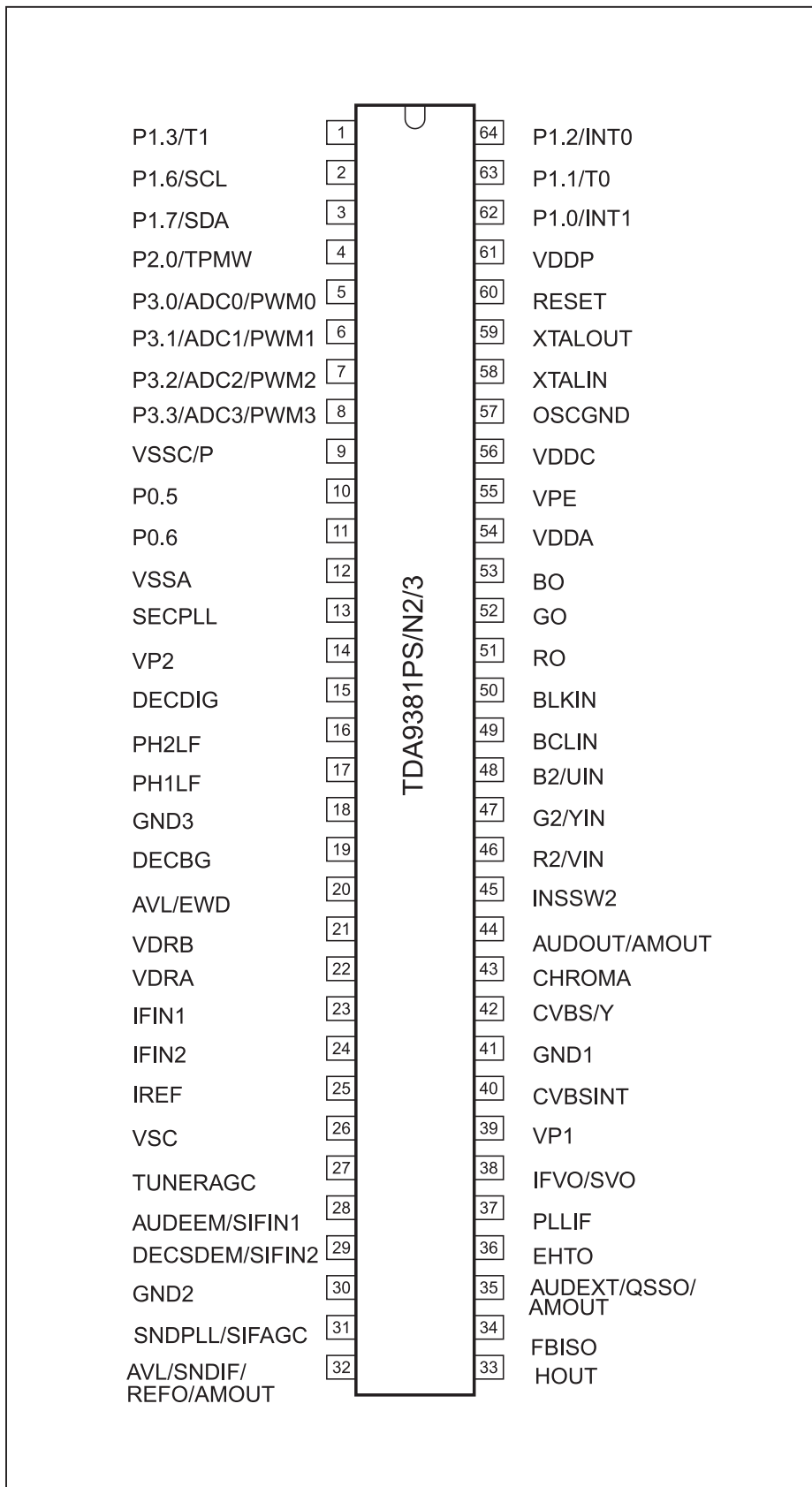

## ■ IC601 - Pins and Functions

Nome	Nº	Descrição
P1.3/T1	1	port 1.3 or Counter/Timer 1 input
P1.6/SCL	2	port 1.6 or I 2 C-bus clock line
P1.7/SDA	3	port 1.7 or I 2 C-bus data line
P2.0/TPWM	4	port 2.0 or Tuning PWM output
P3.0/ADC0/PWM0	5	port 3.0 or ADC0 input or PWM0 output
P3.1/ADC1/PWM1	6	port 3.1 or ADC1 input or PWM1 output
P3.2/ADC2/PWM2	7	port 3.2 or ADC2 input or PWM2 output
P3.3/ADC3/PWM3	8	port 3.3 or ADC3 input or PWM3 output
VSSC/P	9	digital ground for m-Controller core and periphery
P0.5	10	port 0.5 (8 mA current sinking capability for direct drive of LEDs)
P0.6	11	port 0.6 (8 mA current sinking capability for direct drive of LEDs)
VSSA	12	analog ground of Teletext decoder and digital ground of TV-processor
SECPLL	13	SECAM PLL decoupling
VP2	14	2 nd supply voltage TV-processor (+8V)
DECDIG	15	decoupling digital supply of TV-processor
PH2LF	16	phase-2 filter
PH1LF	17	phase-1 filter
GND3	18	ground 3 for TV-processor
DECBG	19	bandgap decoupling
AVL/EWD (1)	20	Automatic Volume Levelling /East-West drive output
VDRB	21	vertical drive B output
VDRA	22	vertical drive A output
IFIN1	23	IF input 1
IFIN2	24	IF input 2
IREF	25	reference current input
VSC	26	vertical sawtooth capacitor
TUNERAGC	27	tuner AGC output
AUDEEM/SIFIN1 (1)	28	audio deemphasis or SIF input 1
DECSDEM/SIFIN2 (1)	29	decoupling sound demodulator or SIF input 2
GND2	30	ground 2 for TV processor
SNDPLL/SIFAGC (1)	31	narrow band PLL filter /AGC sound IF
AVL/SNDIF/REF0/ AMOUT (1)	32	Automatic Volume Levelling / sound IF input / subcarrier reference output /AM output (non controlled)
HOUT	33	horizontal output
FBISO	34	flyback input/sandcastle output
AUDEXT/ QSSO/AMOUT (1)	35	external audio input /QSS intercarrier out /AM audio output (non controlled)
EHTO	36	EHT/overvoltage protection input
PLLIF	37	IF-PLL loop filter
IFVO/SVO	38	IF video output / selected CVBS output
VP1	39	main supply voltage TV-processor (+8 V)
CVBSINT	40	internal CVBS input
GND1	41	ground 1 for TV-processor
CVBS/Y	42	external CVBS/Y input
CHROMA	43	chrominance input (SVHS)
AUDOUT /AMOUT (1)	44	audio output /AM audio output (volume controlled)
INSSW2	45	2 nd RGB / YUV insertion input
R2/VIN	46	2 nd R input / V (R-Y) input
G2/YIN	47	2 nd G input / Y input
B2/UIN	48	2 nd B input / U (B-Y) input
BCLIN	49	beam current limiter input / (V-guard input, note 2)



## ■ IC601 - Pins and Functions

Nome	Nº	Descrição
BLKIN	50	black current input / (V-guard input, note 2)
RO	51	Red output
GO	52	Green output
BO	53	Blue output
VDDA	54	analog supply of Teletext decoder and digital supply of TV-processor (3.3 V)
VPE	55	OTP Programming Voltage
VDDC	56	digital supply to core (3.3 V)
OSCGND	57	oscillator ground supply
XTALIN	58	crystal oscillator input
XTALOUT	59	crystal oscillator output
RESET	60	reset
VDDP	61	digital supply to periphery (+3.3 V)
P1.0/INT1	62	port 1.0 or external interrupt 1 input
P1.1/T0	63	port 1.1 or Counter/Timer 0 input
P1.2/INT0	64	port 1.2 or external interrupt 0 input

## ■ IC601 / IC451 - Voltage Table

IC601							
POWER ON				STAND-BY			
Pin	Voltage	Pin	Voltage	Pin	Voltage	Pin	Voltage
1	3,2V	33	0,6V	1	0V	33	0,9V
2	NC	34	0,8V	2	4,8V	34	0V
3	NC	35	3,8V	3	4,8V	35	1,9V
4	3,3V	36	4,4V	4	0V	36	3,3V
5	0V	37	2,8V	5	4,8V	37	2,2V
6	3,3V	38	3,2V	6	3,3V	38	3,2V
7	3,3V	39	7,8V	7	3,3V	39	5V
8	3,3V	40	4,5V	8	3,3V	40	2,7V
9	0V	41	0V	9	0V	41	0V
10	0V	42	4,5V	10	0V	42	2,4V
11	2,2V	43	0V	11	4,6V	43	0V
12	0V	44	3,5V	12	0V	44	2,2V
13	2,3V	45	0V	13	1,7V	45	0V
14	7,8V	46	0V	14	5,1V	46	0V
15	4,9V	47	0V	15	3,4V	47	0V
16	3,4V	48	0V	16	1,7V	48	0V
17	3,7V	49	2,5V	17	1,7V	49	2V
18	0V	50	5,3V	18	0V	50	3,3V
19	4V	51	3,4V	19	3,2V	51	0,8V
20	0V	52	3,3V	20	0,3V	52	0,8V
21	2,1V	53	3,3V	21	1,3V	53	0,9V
22	2,2V	54	3,3V	22	1,1V	54	3,3V
23	1,8V	55	0V	23	1,6V	55	0V
24	1,8V	56	3,3V	24	1,6V	56	3,3V
25	3,8V	57	0V	25	2,5V	57	0V
26	4,4V	58	nc	26	2,2V	58	1,6V
27	4,1V	59	nc	27	4V	59	1,6V
28	3,2V	60	nc	28	1,8V	60	0V
29	2,3V	61	3,3V	29	0,9V	61	3,3V
30	0V	62	0V	30	0V	62	0V
31	2,3V	63	1,6V	31	1V	63	0V
32	2,5V	64	4,6V	32	1,1V	64	4,8

IC451	
Pin	Voltage
1	3,2V
2	NC
3	NC
4	3,3V
5	0V
6	3,3V
7	3,3V

# IC601 - Block Diagram

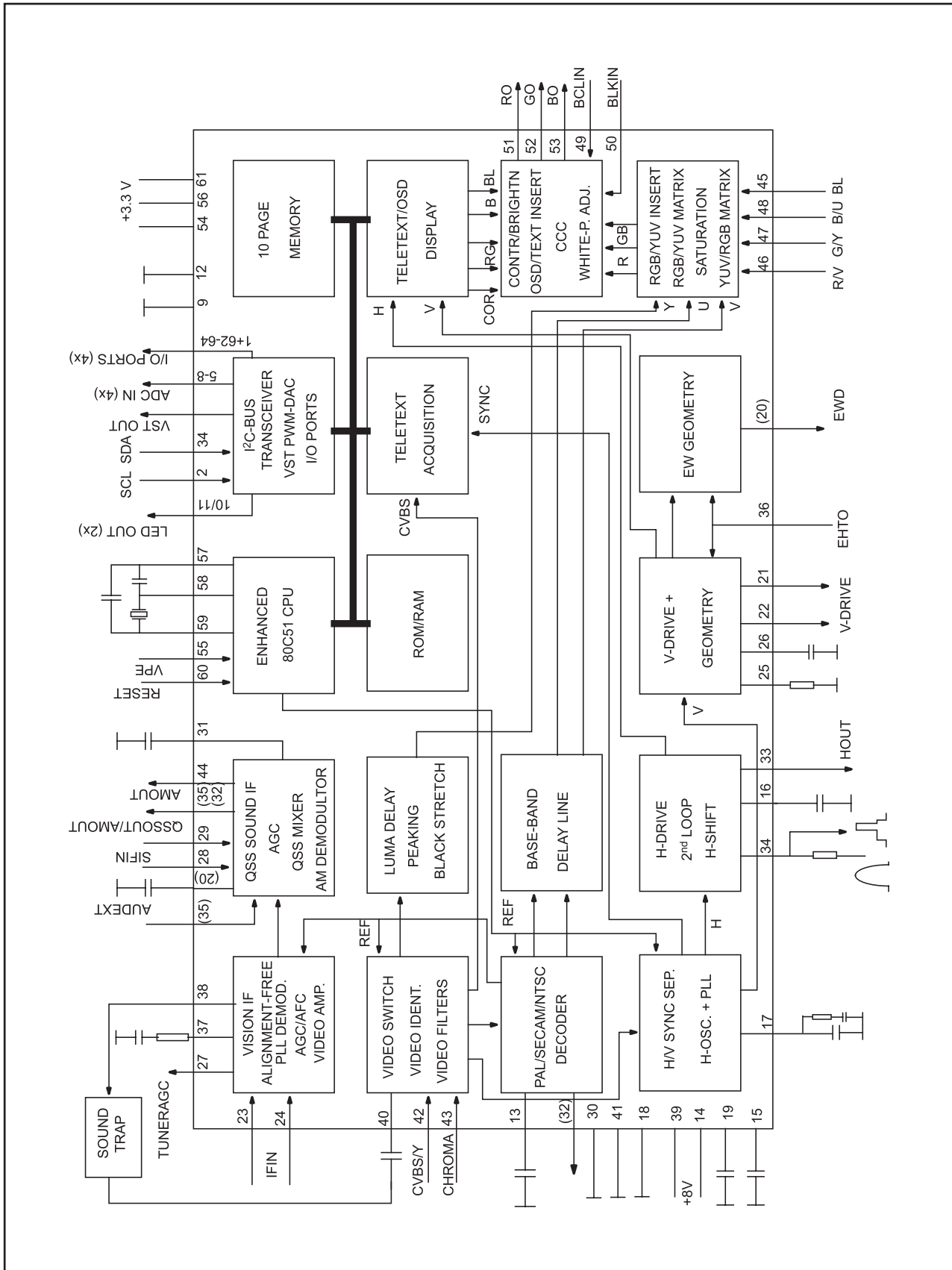

## ■ General Summary

CONFIGURATION	
COLOUR SYSTEM	PAL-M / NTSC / PAL-N (PAL-M 50Hz)
POWER SOURCE	CA Automatic Voltage Selection 110 - 240V AC, 60Hz
MEMORY	100 positions
TUNING RANGE	181 channels
On Screen Display Language	English / Spanish / Portuguese
Áudio System	Mono
Vertical Magnetic Field	-0.1 ±0.03 (BRASIL)
Colour Temperature	<b>TC-14A12P:</b> (High Light) x= 0.260±0.01, y=0.265 ±0.01, Y=300 (nit) (Low Light) x= 0.243±0.01, y=0.255 ±0.01, Y=6.5 (nit)
	<b>TC-20B12:</b> (High Light) x= 0.270±0.01, y=0.275 ±0.01, Y=155 (nit) (Low Light) x= 0.245±0.01, y=0.235 ±0.01, Y=7.0 (nit)

Contents	Reference	Test Point	Adjustment Point	Specifications	
				TC-14A12P	TC-20B12
+B Voltage	002	TPA 12		140.5 ± 1.5 (V)	140.5 ± 1.5 (V)
		TPA 11		8 ± 1 (V)	8 ± 1 (V)
		TPA 10		5 ± 1 (V)	5 ± 1 (V)
		TPA21		215 ± 15 (V)	215 ± 15 (V)
Buzz	007	A22-2 or PA41		0.5 (Vp-p)	0.5 (Vp-p)
PAL colour sign optput	009	TPL2	D	2.45 ± 0.1 (Vo-p)	2.45 ± 0.1 (Vo-p)
		TPL1	C	2.45 ± 0.5 (Vo-p)	2.45 ± 0.5 (Vo-p)
NTSC colour sign output	010	TPL1	C	1.2 ± 0.5 (Vo-p)	1.2 ± 0.5 (Vo-p)
Anode (EHT) voltage	008	CRT		24.5 +0.7 (Kv)	26.5 +0.7 (Kv)
		anode		24.5 – 1.5 (kV)	26.5 – 1.5 (kV)

## ■ Service Adjustments and Calibrations

### TO ENTER IN THE SERVICE MODE:

1. Adjust the volume for the minimum.
2. Adjustment the “**OFF TIMER**” function for 30 minutes.
3. Simultaneously press the “**RECALL**” button of the remote control unit and the “**VOLUME DOWN**” button on the TV set. After some seconds, the TV enters the **SERVICE MODE** and the “**CHK1**” expression should appear on the screen.

### TO EXIT SERVICE MODE AND RETURN TO THE NORMAL STATE:

Press the “**NORMAL**” key on the remote control unit or turn of the unit.

## HOW TO OPERATE THE “DAC” CONTROLS IN THE BR3L CHASSIS

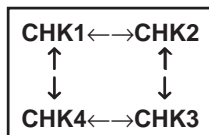

To change from “**CHK1**” to “**CHK2**” mode and following, press “**2**” to move forward and “**1**” to go back.

### ADJUSTMENTS IN THE CHK1 MODE:

CHK1 OPTIONS	
OPTIONS	PAR
1	C 1
2	0 0
3	0 0
4	3 3
5	8 0
6	0 0
7	0 0
8	0 0

### ADJUSTMENTS IN THE CHK2 MODE:

CHK2 OPTIONS	
OPTIONS	PAR
RF-AGC	31
CONTRAST	63
COLOUR	32
SUB-COLOUR	32
NTSC-TINT	32
SUB-NTSC-TINT	30
BRIGHT	32

### ADJUSTMENTS IN THE CHK3 MODE:

CHK3 OPTIONS	
OPTIONS	PAR
V-SLOPE	37
V-SHIFT 50Hz	2
V-SHIFT 60Hz	1
V-AMP 50Hz	16
V-AMP 60Hz	16
H-SHIFT	36
S-CORR 50Hz	18
S-CORR 60Hz	18
V-ZOOM 50 Hz	5
V-ZOOM 60 Hz	7
OSD H-POS	3
OSD V-POS 50 Hz	28
OSD V-POS 60 Hz	21

### ADJUSTMENTS IN THE CHK4 MODE:

CHK4 OPTIONS	
OPTIONS	PAR
R-CUT	31
G-CUT	32
BRIGHT	32
SUB-BRIGHT	31
CONTRAST	63
SUB-CONTRAST	21
R-DR	19
G-DR	31
B-DR	38
RGB CONTRAST	6

### NOTE:

- To select the options, press “**4**” to move forward and “**3**” to go back.
- Select the option and make the adjustment pressing the “**VOL-**” or “**VOL+**” keys.
- To memorize the adjustment press “**0**” (**CHK1** mode only).

- To turn off AKB (blue OSD), press “**5**”. To turn on AKB (white OSD), press “**5**” of the remote control unit.
- After end of the adjustments, press the “**NORMAL**” key “ or turn of the unit to return to the normal mode of TV.
- To do data memory maintenance, simultaneously press “**MUTE**” on the remote control and “**VOL-**” on the TV set when it is in **SERVICE MODE** . To select the memory address, press “**4**” to move forward or “**3**” to go back.)

## ■ Service Adjustments and Calibrations

### TEST EQUIPMENT

To do all of these electrical adjustments, the following equipment is required:

- Dual-Trace Oscilloscope  
Voltage Range: 0.001 V to 50 V/Div.  
Frequency Range: DC to 50 MHz  
Probes: 10:1, 1:1
- NTSC Video Pattern Generator
- DVM (Digital Volt Meter)
- MTS/SAP Signal Generator
- (TV Multi-Channel Sound Modulator (U.S.A.))
- Plastic Tip Driver and Non-Metal Driver
- Isolation Transformer (Variable)
- Degaussing Coil
- White Pattern Generator
- Audio Generator

### AGC RF CALIBRATION

#### 1. PREPARATION:

- 1.1. Receive a color bar pattern and assure a RF input signal of 75Ω opened, channel 13 (211.25 MHz).
- 1.2. Connect the digital multimeter in TPA 15.

#### 2. CALIBRATION:

- 2.1. Select the option "RF AGC" in the "CHK2" service mode.
- 2.2. Adjust RF AGC to 2.2±0.1V in TPA20.
- 2.3. Increase the input level by +2 dB and confirm that the voltage decrease.

Tuner	ENV56D75G3R	TEDH9-301A
Level	69dB mV	69dB mV

### VIF DETECTOR OUTPUT LEVEL CONFIRMATION

#### 1. CALIBRATION:

- 1.1. Install the chassis in the VIF calibration JIG and receive a color bar pattern with 63 dBu (75Ω opened).
- 1.2. Connect the oscilloscope to TPA33.
- 1.3. Confirm that the video output signal is within a range of 1.05 ± 0.15 Vp-p in TPA33.

### BUZZ (SOUND CIRCUIT)

#### 1. PREPARATION:

- 1.1. Connect the oscilloscope with a 7kHz filter between TP A41 and ground or between the speaker's terminals
- 1.2. Adjust the sound volume to the maximum.
- 1.3. Set "TONE" to "NORMAL" and "AVL" turned off.

#### 2. CONFIRMATION:

- 2.1. Receive a color bar pattern channel 2, with local frequency adjusted and the AFC turned on (Channel with sound bearer and without modulation).
- 2.2. Assure that the width in the buzzing waveform is smaller than 500 m Vp-p.

### ANODE AND HEATER VOLTAGE CONFIRMATION

#### 1. PREPARATION:

- 1.1. Receive a crosshatch pattern.
- 1.2. Adjust the bunch current in zero. (0 beam)
- 1.3. Adjust "SCREEN VR" and "CONTRAST" to minimum.

#### 2. CONFIRMATION:

- 2.1. Connect a voltage meter between TAP12 and ground. Confirm that the voltage +B is within a range of 140.5V± 1.5V
- 2.2. Connect a high frequency voltage meter (VRMS.) among the heater, and confirm that the reads tension is within a range of 6.3 ± 0.24 (VRMS)
- 2.3. Connect the high voltage meter in the CR T anode pin, and confirm that the high voltage is within a range of [A]:
  - TC-14A12P [A]=24.5 +0.7kV -1.5kV
  - TC-20B12 [A]=26.5 +0.7kV -1.5kV

### PAL COLOR OUTPUT SIGNAL ADJUSTMENT

#### 1. PREPARATION:

- 1.1. Receive a color bar pattern and adjust the local frequency.
- 1.2. Adjust "IMAGE" to DYNAMIC NORMAL, "CONTRAST" to 63 and "SUB-CONTRAST" to 21.
- 1.3. Adjust the "COLOR FOR CHANNEL" level to NORMAL.
- 1.4. Set the CHK2 service mode option, press "5" on the remote control unit and confirm that OSD becomes blue (AKB turned off).
- 1.5. Connect a short circuit jumper between TPA10 and TPA20.
- 1.6. Adjust [A] for 2.3 ± 0.2V through the BRIGHT control variation in the test point TPL2.
- 1.7. Fix G-DRIVE GAIN, R-DRIVE GAIN and B-DRIVE GAIN data in 1FH or 31 DAC.

#### 2. CALIBRATION:

- 2.1. Connect the oscilloscope in TPL2 (G-OUT) with a 10K Ω resistor and adjust "CONTRAST", so that the waveform in [B] it is of 2.6±0.1V according to fig. 1.
- 2.2. Adjust "SUB-COLOR" to obtain 2.45±0.1V in [D] according to fig. 1.
3. Connect the oscilloscope in TPL1 (R-OUT) a 10KΩ resistor in and confirm that the waveform in [C] it is of 2.45±0.1V according to fig. 2.
4. Remove the jumper between TPA10 and TPA20, press "5" and confirm that OSD becomes white (AKB turned on).

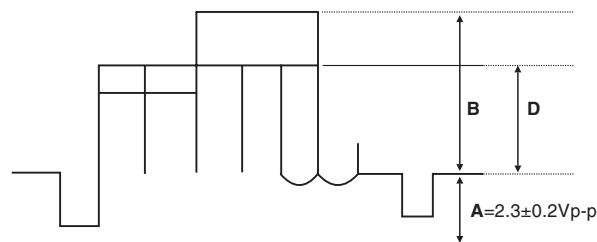

Fig. 1

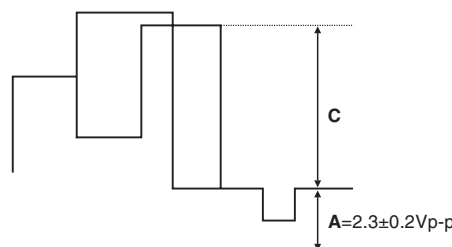

Fig. 2

# Service Adjustments and Calibrations

## NTSC SUB-TINT CALIBRATION

### 1. PREPARATION:

- 1.1. Connect the oscilloscope to TPL1 (R OUT) in serie with a 10KΩ resistor.
- 1.2. Receive a rainbow pattern through VIDEO IN.
- 1.3. Adjust "IMAGE" to DYNAMIC NORMAL.
- 1.4. Adjust "COLOR FOR CHANNEL" to NORMAL.
- 1.5. Set the CHK2 service mode option, press "5" on the remote control unit and confirm that OSD becomes blue (AKB turned off).
- 1.6. Connect a short circuit jumper between TPA10 and TPA20.

### 2. CALIBRATION:

- 2.1. Adjust [C] for  $5.0 \pm 0.2V$  through the BRIGHT control variation according to fig. 1.
- 2.2. Adjust the NTSC SUB-TINT level according to fig. 1 positions 2, 3 and 4.
- 2.3. Remove the jumper, press "5" and confirm that OSD becomes white (AKB turned on).

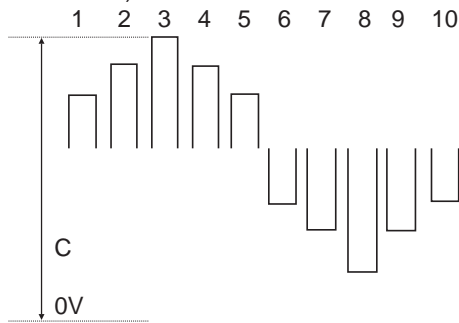

Fig. 1

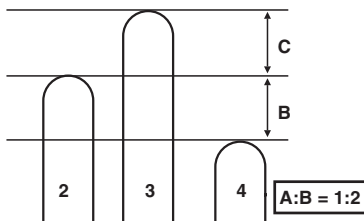

Fig. 2

## PROTECTION CIRCUIT (SHUTDOWN) CONFIRMATION OF OPERATION

### 1. PREPARATION:

- 1.1. Receive a crosshatch pattern.
- 1.2. Adjust CONTRAST and BRIGHT controls to minimum.

### 2. CONFIRMATION:

- 2.1. Connect the voltmeter in TPA22 and confirm that the voltage is smaller than [A].
- 2.2. Connect a DC source in TPA22 and confirm that the protection circuit doesn't act when the voltage is [B].
- 2.3. Confirm that the protection circuit acts with smaller voltage than [C].

Condition	14 inches	20 inches
A	19,67V	21,18V
B	20,66V	22,31V
C	22,49V	24,37V

## WHITE QUALITY CALIBRATION

### 1. PREPARATION:

- 1.1. Adjust the HELMHOLTZ device to local magnetic field. Horizontal:  $0 \pm 0.003 \times 10^{-4}T$
- 1.2. Receive a white purity pattern.
- 1.3. Adjust CONTRAST and BRIGHT controls to maximum.
- 1.4. Previously adjust the CONVERGENCE.
- 1.5. Fully degauss the CRT by using an external degaussing coil.

### 2. CALIBRATION:

- 2.1. Adjust the magnetic field in  $0.4 \times 10^{-4}T$  (400 mG), and check the white quality with the CRT turned to EAST and to WEST.
- 2.2. Receive a red pattern, adjust the COLOR control to maximum and confirm the purity adjustment.
- 2.3. If purity error is found at the CRT corners, to apply magnetic tapes to correct it, fully degauss the CRT again and repeat the steps 1 and 2. Don't use this magnetic tapes on the internal side of the yoke.
- 2.4. Receive a white purity pattern, adjust the COLOR control to maximum and confirm the purity adjustment.

## VERTICAL DEFLECTION CALIBRATION AND CONFIRMATION

### 1. PREPARATION:

- 1.1. Adjust the HELMHOLTZ device to the local magnetic field
- 1.2. Adjust IMAGE to DYNAMIC NORMAL.

### 2. CONFIRMATION AND CALIBRATION S-CORR :

#### • CONFIRMATION IN 50HZ

- 2.1. Receive a PAL-N Philips pattern
- 2.2. Confirm that S-CORR 50Hz is in [18] DAC.

#### • CONFIRMATION IN 60HZ

- 2.3. Receive a monoscope pattern.
- 2.4. Confirm that S-CORR 60Hz is in [18] DAC.

#### • V-SLOPE CALIBRATION

- 2.5. Receive a monoscope pattern.
- 2.6. Adjust V\_SLOPE so that the beginning of the black part of the image be aligned with the center of the CRT as below.

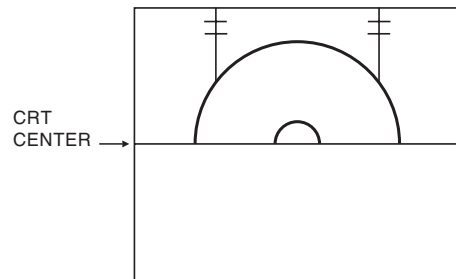

### 3. VERTICAL CENTRALIZATION 50 HZ CALIBRATION

- 3.1. Receive a PAL-N Philips pattern
- 3.2 Adjust V-SHIFT 50Hz so that Philips pattern's center is in the CRT center.

### 4. VERTICAL CENTRALIZATION 60 HZ CALIBRATION

- 4.1. Receive a monoscope pattern.
- 4.2. Adjust V-SHIFT 60Hz so that the monoscope pattern's center is in the CRT center

## ■ Service Adjustments and Calibrations

### 5. VERTICAL HEIGHT (V-AMP 50HZ) CALIBRATION

- 5.1. Receive a PAL-N Philips pattern.
- 5.2. Adjust V-AMP-50Hz so that the Philips pattern's circle height be the same dimension of the width.

### 6. VERTICAL HEIGHT (V-AMP 60HZ) CALIBRATION

- 6.1. Receive a monoscope pattern.
- 6.2. Adjust V-AMP-60Hz so that:
  - [C] and [D] (see below) be 1.9~2.2 (typical 2.0) for 14 inches and 1.5~2.0 for 20 inches.
  - [A] and [B] be 1.5~2.3 (typical 2.0) for 14 inches and 1.5~1.6 for 20 inches.
- 6.3. Memorize in EEPROM.

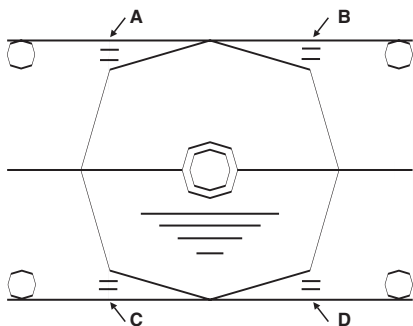

#### CRT CUT OFF CALIBRATION

##### 1. PREPARATION:

- 1.1. Receive a monoscope pattern.
- 1.2. Position DACs with the data below:
  - BRT AND S-BRT = 32H.
  - RGB CONTRAST = 06H for 14 inches and 07H for 20 inches.
  - SUB-CONTRAST = 21H
  - R,G,B DRIVE = 31H
  - R,G CUT = 31H
- 1.3. Press "5" (AKB OFF) and confirm that OSD becomes blue.
- 1.4. Connect the oscilloscope in TPL7 and adjust BR T to obtain 130V in the figure below.
- 1.5 Adjust screen to minimum.

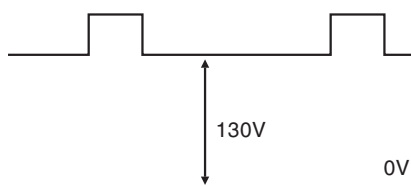

- 1.6. Press "5" (AKB ON) and confirm that OSD becomes white.

#### WHITE BALANCE CALIBRATION

##### 1. PREPARATION:

- 1.1. This adjustment should be accomplished after 30 minutes of heating.
- 1.2. Receive a white balance. (This sign should contain burst sign).
- 1.3. Position DAC of MENU OF IMAGE for DYNAMIC NORMAL.
- 1.4. Fully degauss the CRT by using an external degaussing coil.
- 1.5. Position the color analyzer in contact with the face of CRT.

- Assure that the CUT OFF voltage calibration has been done.
- If the value in the color analyzer is below Y(H) date, adjust CONTRAST for 32 and connect a short circuit jumper between TPA10 and TPA20.

### 2. CALIBRATION:

#### [1] LOW LIGHT CALIBRATION

1. Adjust S-BRT, so that  $Y = Y(L)$ .
2. Adjust R-CUT OFF, so that  $x = x(L)$ .
3. Adjust G-CUT OFF, so that  $y = y(L)$ .

#### [2] HIGH LIGHT CALIBRATION

1. Adjust S-BRT, so that  $Y = Y(H)$ .
2. Adjust R-DRIVE, so that  $x = x(H)$ .
3. Adjust B-DRIVE, so that  $y = y(H)$ .

#### [3] Repeat the procedures [1] and [2].

#### SUB-BRIGHTNESS CALIBRATION

##### 1. PREPARATION:

- 1.1. Receive a windows pattern.
- 1.2. Position MENU OF IMAGE in DYNAMIC NORMAL.

##### 2. CALIBRATION:

- 2.1. Position the color analyzer in an low light image area of CR.
- 2.2. Adjust S-BRT <CHK 5>, so that  $Y=5.5 \pm 0.2$ .

#### SUB-CONTRAST CALIBRATION

##### 1. PREPARATION:

- 1.1. Receive a windows pattern.
- 1.2. Position MENU OF IMAGE in DYNAMIC NORMAL.

##### 2. CALIBRATION:

- 2.1. Position the color analyzer in an high light image area of CR
2. Adjust the SUB-CONTRAST <CHK 4>, so that  $Y=300 \pm 10$  for 14 inches and  $Y=160 \pm 10$  for 20 inches.
3. If it is impossible to obtain the adjustment above, adjust the SUB-CONTRAST <CHK 4> and confirm the SUB-BRIGHTNESS adjustment.

#### FOCUS CALIBRATION

##### 1. PREPARATION:

- Assure that the SUB-BRIGHTNESS adjustment has been done.

- 1.1. Receive a Philips or monoscope pattern.
- 1.2. Position MENU OF IMAGE in DYNAMIC NORMAL.

##### 2. CALIBRATION:

- 2.1. Adjust the FOCUS variable resistor.

##### Using the Philips pattern:

- Take as reference to 3rd vertical line.

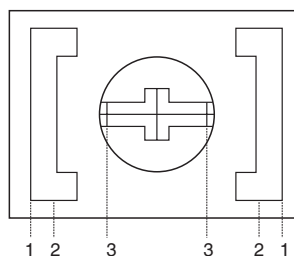

##### Using the monoscope pattern:

- In the number 4

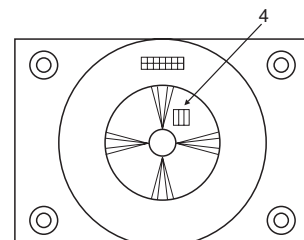

## Service Adjustments and Calibrations

### COLOR PURITY ADJUSTMENT

1. Position the CRT face turned to east or west.
2. Set Bright and Contrast controls to their maximum positions.
3. Leave the set heating up for 60 minutes at white screen.
4. Fully degauss the picture tube by using an external degauss coil.
5. Apply a red pattern.
6. Loosen a clamp screw for the deflection yoke and move it forward or backward until a uniform red screen is obtained.

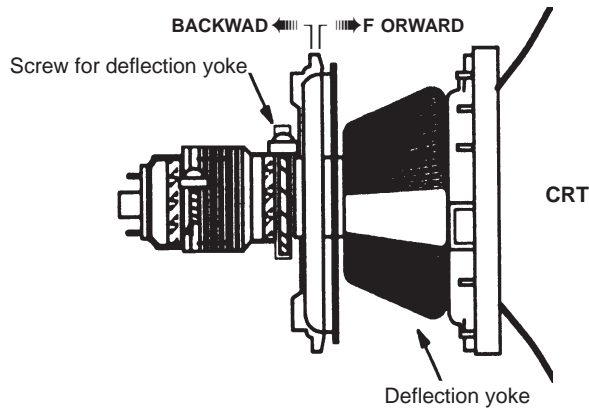
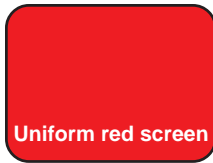

7. Adjust roughly the Low Light controls and make sure that a uniform white field is obtained.
8. Tighten the clamp screw.

### CONVERGENCE CALIBRATION

1. Receive a crosshatch pattern and set Contrast control to the maximum position.
2. Adjust Bright control to obtain a clear pattern.
3. Remove the DY wedges and slightly tilt the deflection yoke to the vertically and horizontally to obtain the good overall convergence.

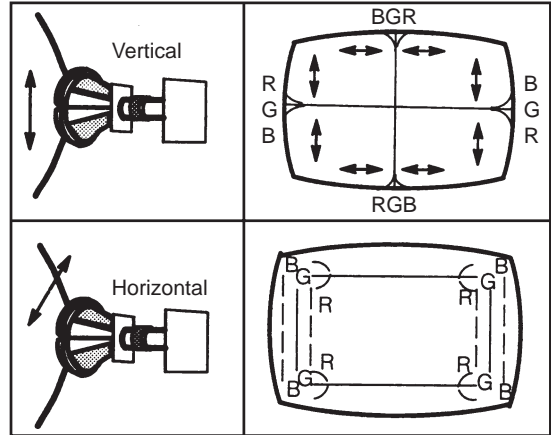

4. Fix the deflection yoke by reinserting the DY wedges as showed below.

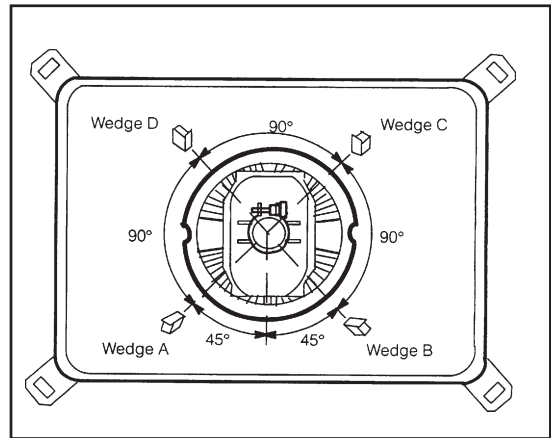

5. If purity error is found, repeat "Color Purity" adjustment

#### Notes:

- Wedge A showed above should be fixed within a range of 45° to the left of the vertical line shown.
- After inserting wedge A, insert wedges B, C and D. The wedges should be set 90° apart from each other.
- Be certain that the four wedges are firmly fixed and the Deflection Yoke is tightly clamped in place. Otherwise the Deflection Yoke may shift its position and cause a loss of convergence and purity.



## EEPROM - Memory Maps

EEPROM X' A0' address (0XX)

	00	01	02	03	04	05	06	07	08	09	0A	0B	0C	0D	0E	0F
00	02	00	06	01	00	06	02	00	06	03	00	06	04	00	06	05
10	00	06	06	00	06	07	00	06	08	00	06	09	00	06	0A	00
20	06	0B	00	06	0C	00	06	0D	00	06	0E	00	06	0F	00	06
30	10	00	06	11	00	06	12	00	06	13	00	06	14	00	06	15
40	00	06	16	00	06	17	00	06	18	00	06	19	00	06	1A	00
50	06	1B	00	06	1C	00	06	1D	00	06	1E	00	06	1F	00	06
60	20	00	06	21	00	06	22	00	06	23	00	06	24	00	06	25
70	00	06	26	00	06	27	00	06	28	00	06	29	00	06	2A	00
80	06	2B	00	06	2C	00	06	2D	00	06	2E	00	06	2F	00	06
90	30	00	06	31	00	06	32	00	06	33	00	06	34	00	06	35
A0	00	06	36	00	06	37	00	06	38	00	06	39	00	06	3A	00
B0	06	3B	00	06	3C	00	06	3D	00	06	3E	00	06	3F	00	06
C0	40	00	06	41	00	06	42	00	06	43	00	06	44	00	06	45
D0	00	06	46	00	06	47	00	06	48	00	06	49	00	06	4A	00
E0	06	4B	00	06	4C	00	06	4D	00	06	4E	00	06	4F	00	06
F0	50	00	06	51	00	06	52	00	06	53	00	06	54	00	06	55

EEPROM X' A4' address (2XX)

	00	01	02	03	04	05	06	07	08	09	0A	0B	0C	0D	0E	0F
00	02	00	A5	5A	00	01	00	00	00	08	00	04	00	00	01	00
10	00	00	00	00	00	00	00	00	20	00	00	00	00	00	00	00
20	00	00	00	00	00	00	00	00	00	00	00	00	00	00	00	00
30	00	00	00	00	00	00	00	00	00	00	00	00	00	00	00	00
40	00	00	00	00	00	00	00	00	00	00	00	00	00	00	00	00
50	20	20	20	3F	2D	20	20	20	2D	20	1E	20	20	23	20	00
60	00	00	01	00	00	00	00	00	00	00	00	00	00	00	00	00
70	00	00	00	00	00	00	00	00	00	00	00	00	00	00	90	D0
80	20	20	20	3F	OP	20	20	20	2D	20	1E	20	20	23	1E	01
90	00	00	00	00	00	00	00	00	00	00	00	00	00	00	00	00
A0	00	00	00	00	00	00	00	00	00	00	00	00	00	00	00	00
B0	03	1C	15	00	00	00	00	00	00	00	00	00	00	00	00	00
C0	00	00	00	00	00	00	00	00	00	00	00	00	00	00	00	00
D0	0C	05	0C	04	00	00	00	00	00	00	00	00	00	00	00	00
E0	00	00	00	00	00	00	00	00	00	C1	00	00	33	80	00	01
F0	00	00	18	20	15	1A	00	00	00	00	00	00	00	A5	3F	A5

EEPROM X' A2' address (1XX)

	00	01	02	03	04	05	06	07	08	09	0A	0B	0C	0D	0E	0F
00	00	06	56	00	06	57	00	06	58	00	06	59	00	06	5A	00
10	06	5B	00	06	5C	00	06	5D	00	06	5E	00	06	5F	00	06
20	60	00	06	61	00	06	62	00	06	63	00	06	64	00	06	65
30	00	06	66	00	06	67	00	06	68	00	06	69	00	06	6A	00
40	06	6B	00	06	6C	00	06	6D	00	06	6E	00	06	6F	00	06
50	70	00	06	71	00	06	72	00	06	73	00	06	74	00	06	75
60	00	06	76	00	06	77	00	06	78	00	06	79	00	06	7A	00
70	06	7B	00	06	7C	00	06	7D	00	06	00	00	00	00	00	00
80	00	00	00	00	00	00	00	00	00	00	00	00	00	00	00	00
90	00	00	00	00	00	00	00	00	00	00	00	00	00	00	00	00
A0	06	00	00	00	00	00	00	00	00	00	00	00	00	00	00	00
B0	00	00	00	00	00	00	00	00	00	00	00	00	00	00	00	00
C0	00	00	00	00	00	00	00	00	00	00	00	00	00	00	00	00
D0	00	00	00	00	00	00	00	00	00	00	00	00	00	00	00	00
E0	00	00	00	00	00	00	00	00	00	00	00	00	00	00	00	00
F0	00	00	00	00	00	00	00	00	00	00	00	00	00	00	00	00

EEPROM X' A6' address (3XX)

	00	01	02	03	04	05	06	07	08	09	0A	0B	0C	0D	0E	0F
00	00	00	00	00	00	00	00	00	00	00	00	00	00	00	00	00
10	00	00	00	00	00	00	00	00	00	00	00	00	00	00	00	00
20	00	00	00	00	00	00	00	00	00	00	00	00	00	00	00	00
30	1B	20	00	22	17	1A	0F	0F	2B	24	1F	12	20	19	1F	1F
40	1F	1F	1F	00	06	00	00	00	10	29	C0	00	2A	00	34	2C
50	30	21	02	4A	OP	44	00	00	00	00	00	FE	00	00	00	00
60	02	FF	1C	12	19	00	00	00	00	00	00	00	00	00	00	00
70	00	00	00	00	00	00	00	00	10	00	00	00	00	00	00	00
80	00	00	00	00	00	00	00	0E	11	0D	06	0C	07	0C	02	00
90	09	00	OP	00	00	00	0A	F8	FD	00	00	00	00	00	00	03
A0	01	03	02	03	03	00	34	00	00	00	2C	63	03	00	20	30
B0	CA	49	4B	00	33	00	FF	FC	04	05	05	03	F8	OP	F2	00
C0	20	07	4F	40	40	00	00	00	00	00	00	00	00	00	00	00
D0	00	00	00	00	00	00	00	00	00	00	00	00	00	00	00	00
E0	00	00	00	00	00	00	00	00	00	00	00	00	00	00	00	00
F0	00	00	00	00	00	00	00	00	00	00	00	00	00	00	00	11

## Power Source Voltages

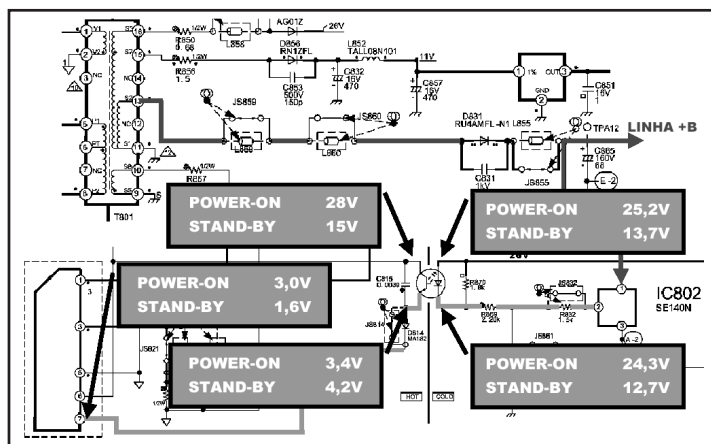
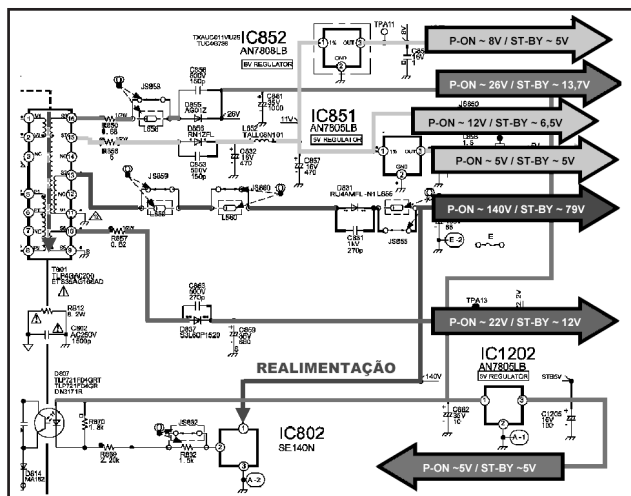

[Click here to play the Power Source Voltages presentation \(MS PowerPoint is necessary\)](#)

# Main Board Schematic Diagram - TC-14A12P / TC-20B12

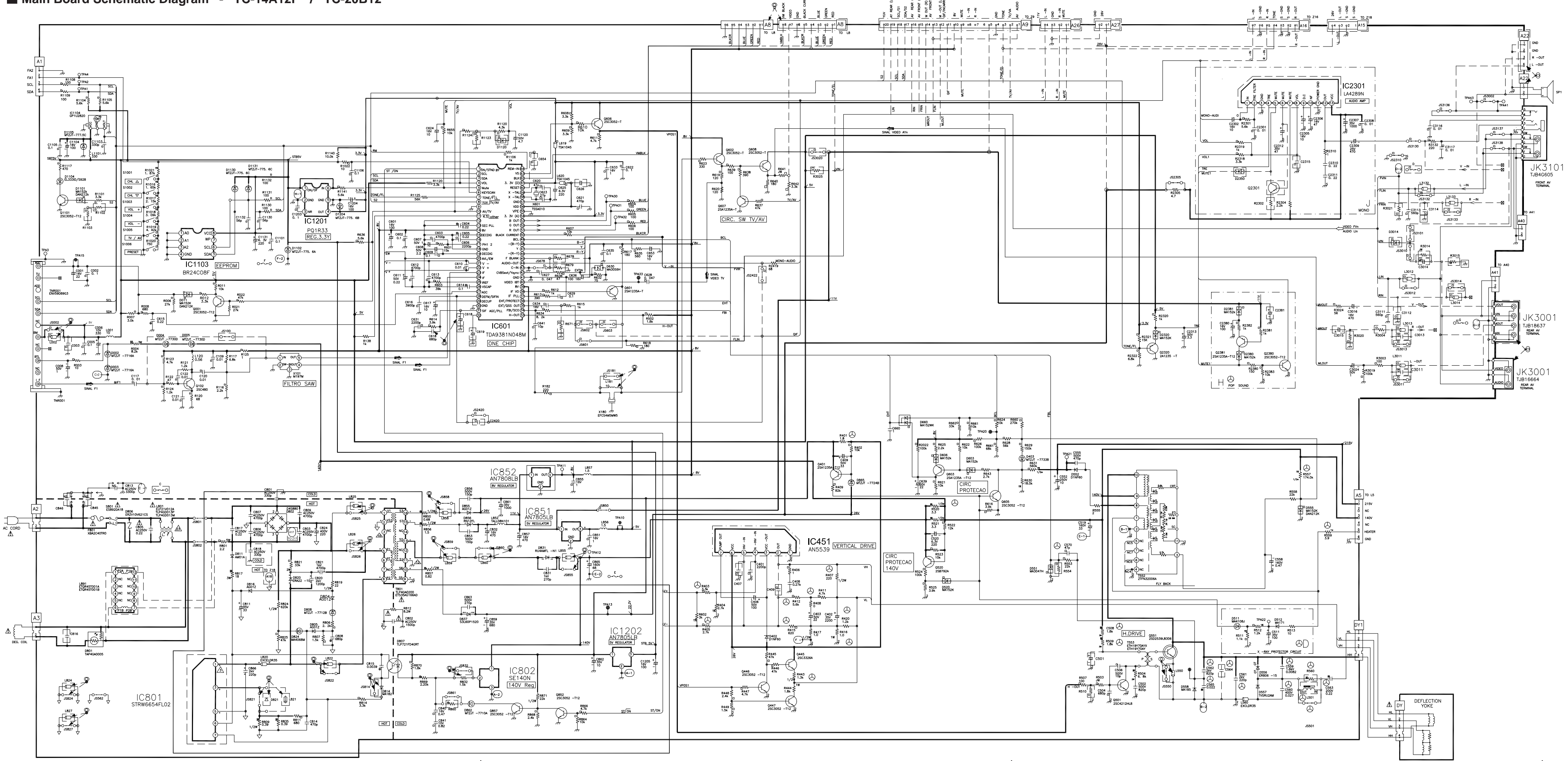

# CRT - Board Schematic Diagram

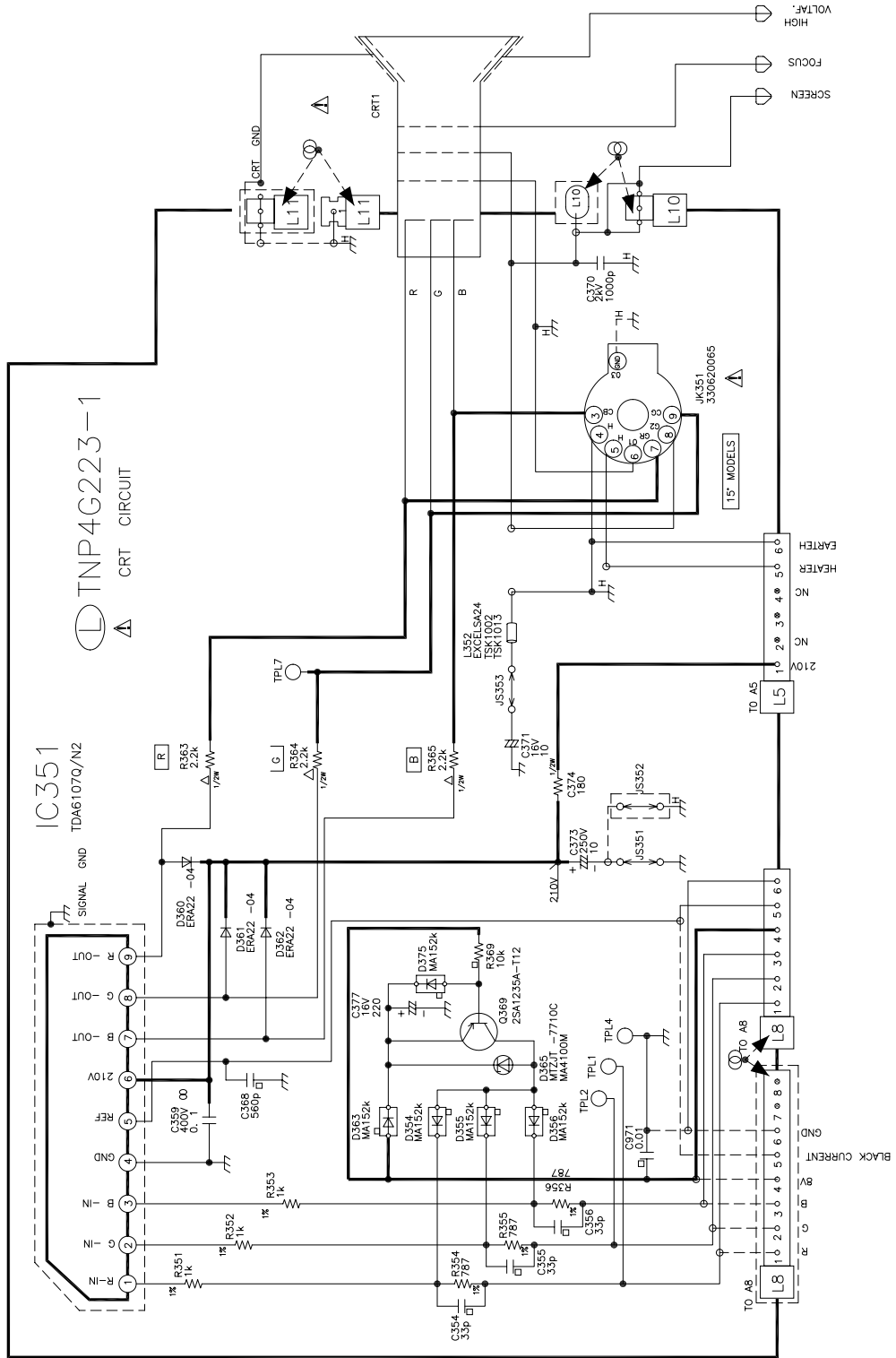

■ Main Board Conductor View (left / component side)

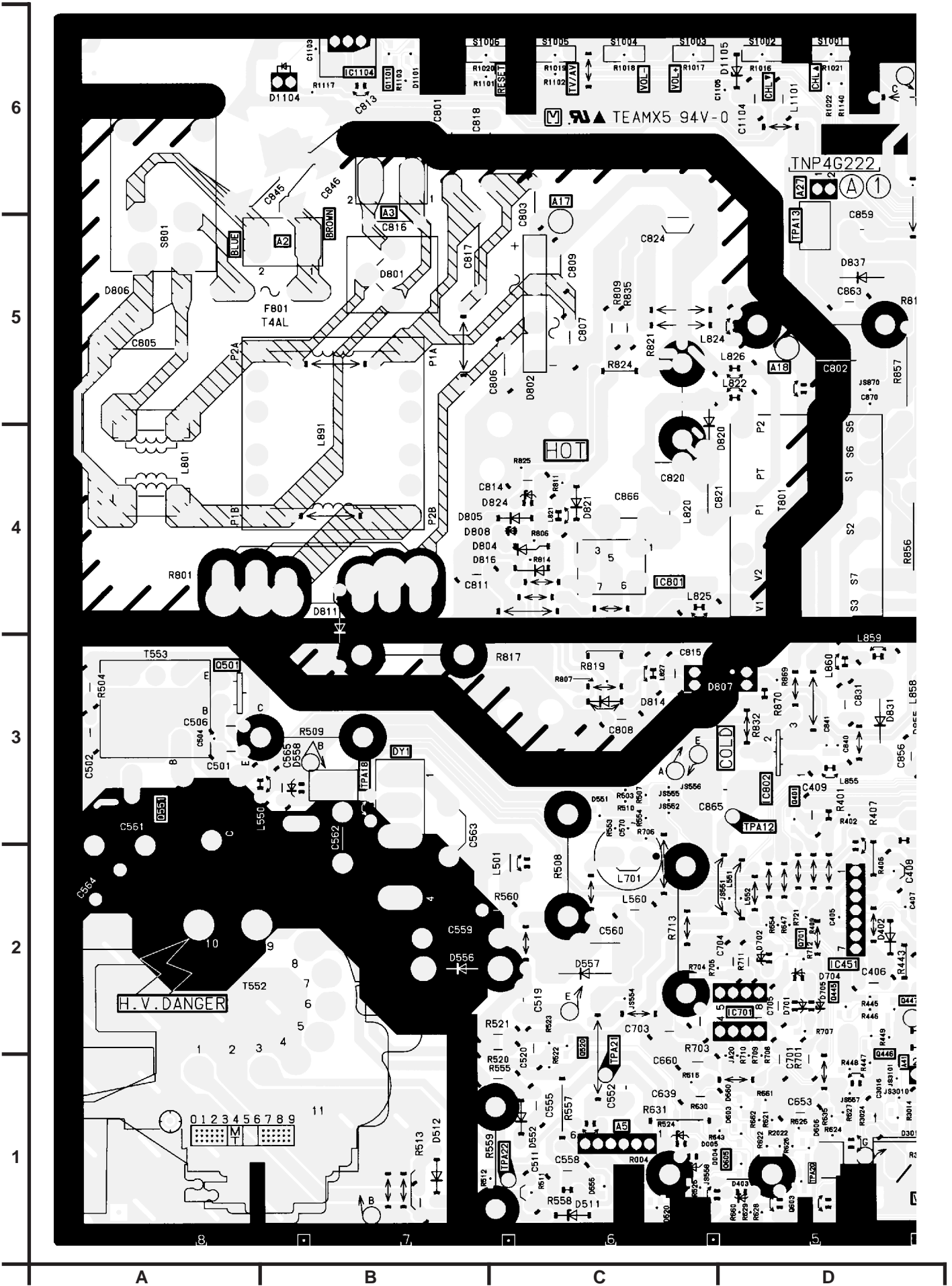



Main Board Conductor View (right / component side)

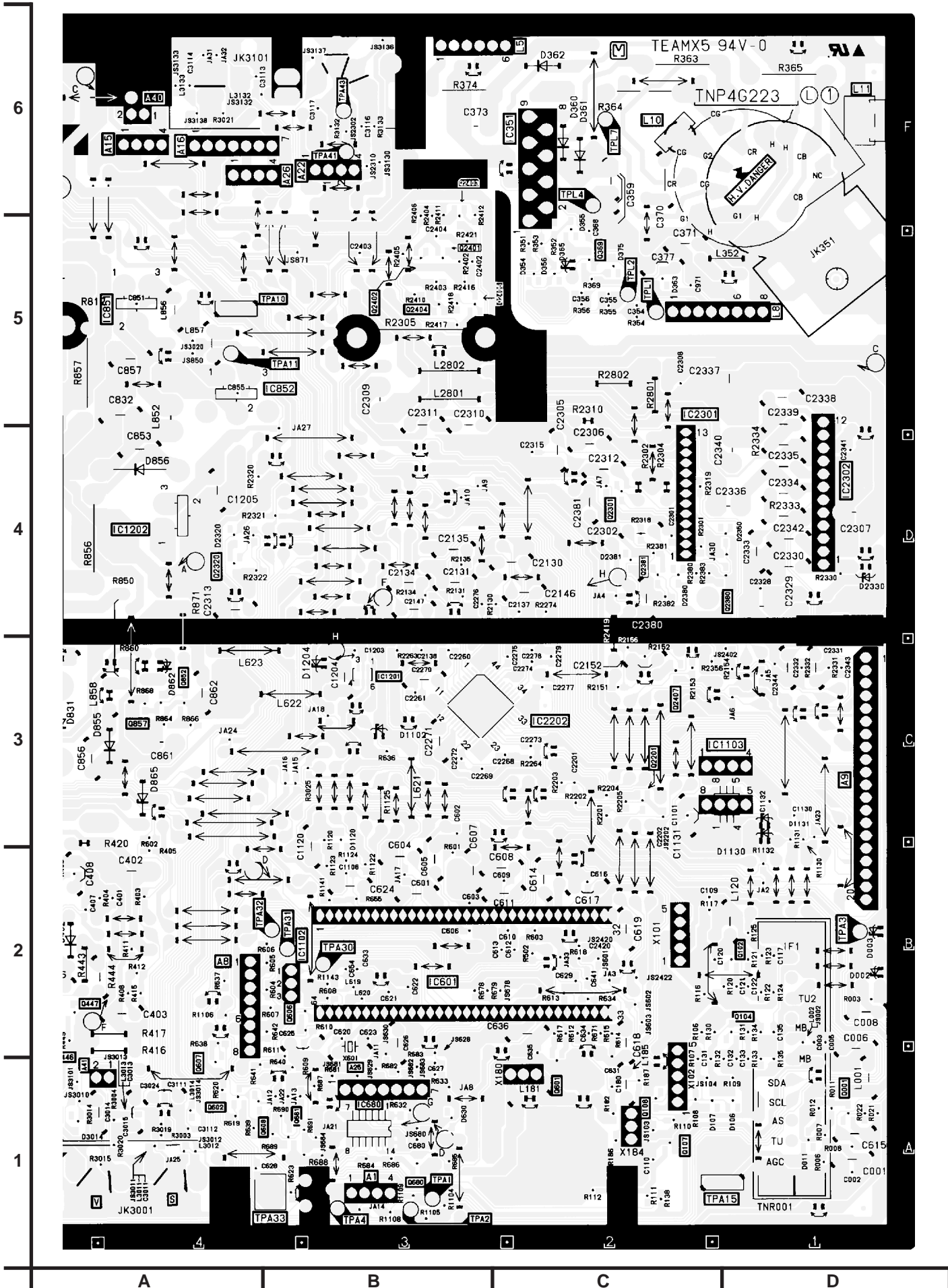



■ Main Board Conductor View (right / foil side)

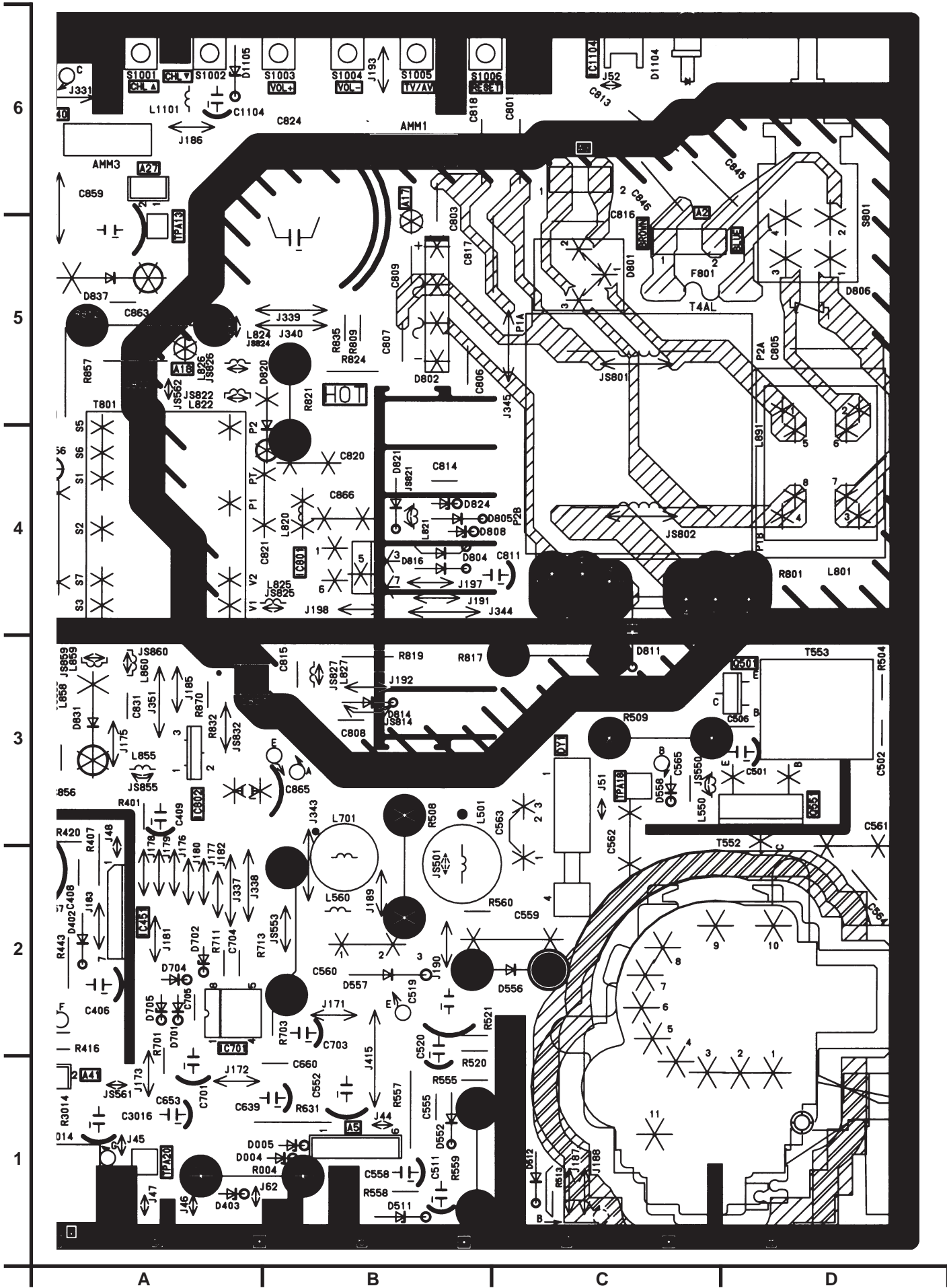

## Waveform

- All the waveforms had read with 127V power source and receiving a colorbar pattern.

### IC601

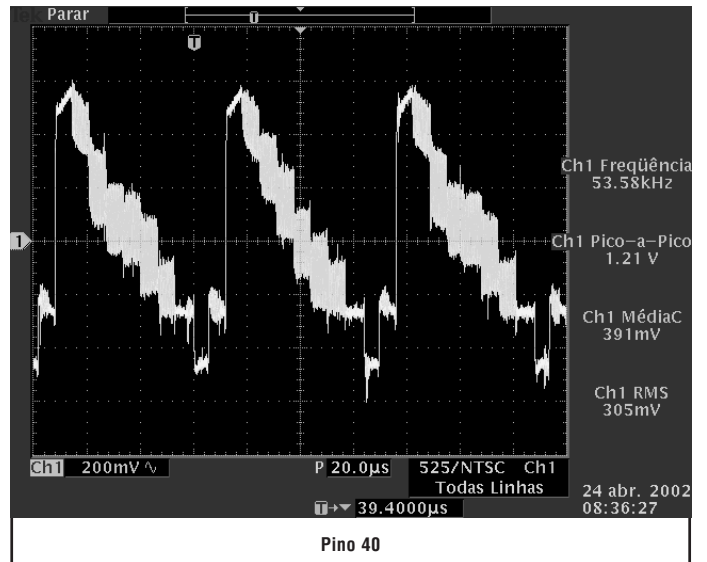
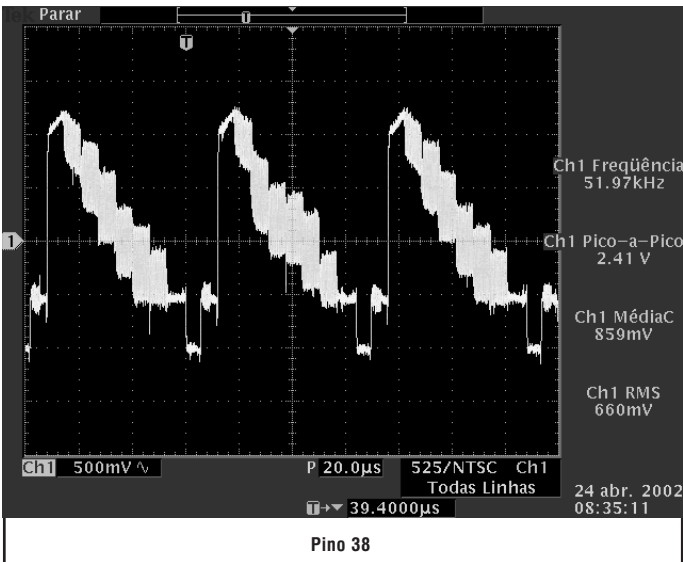
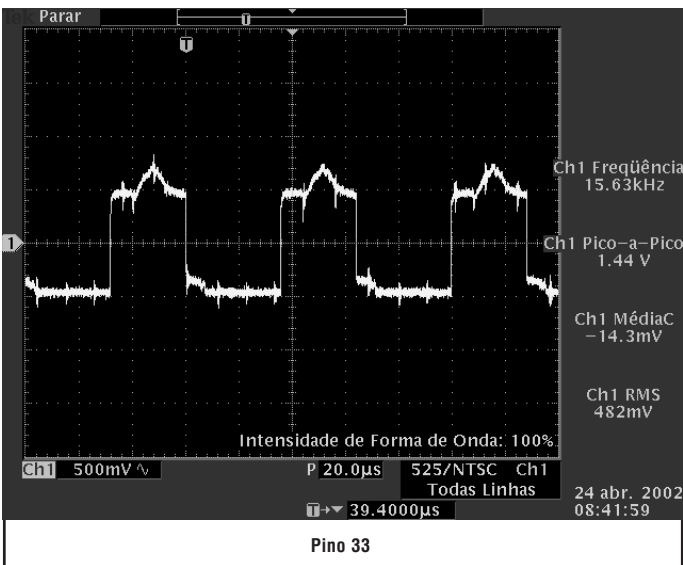
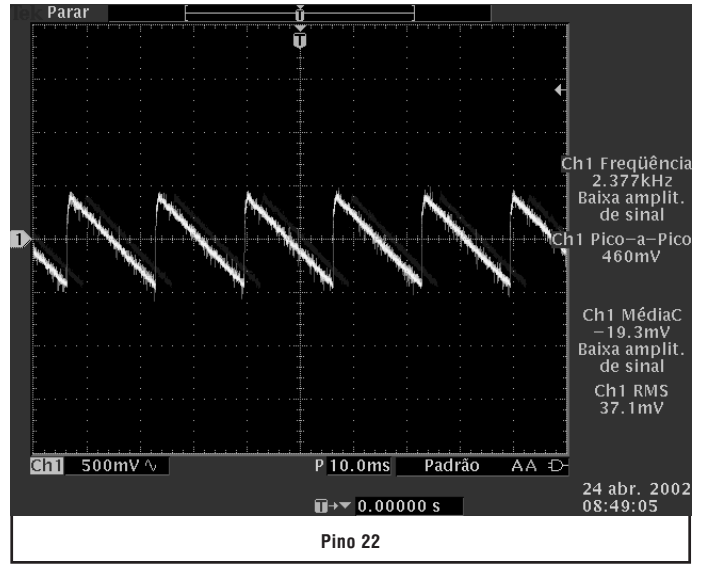
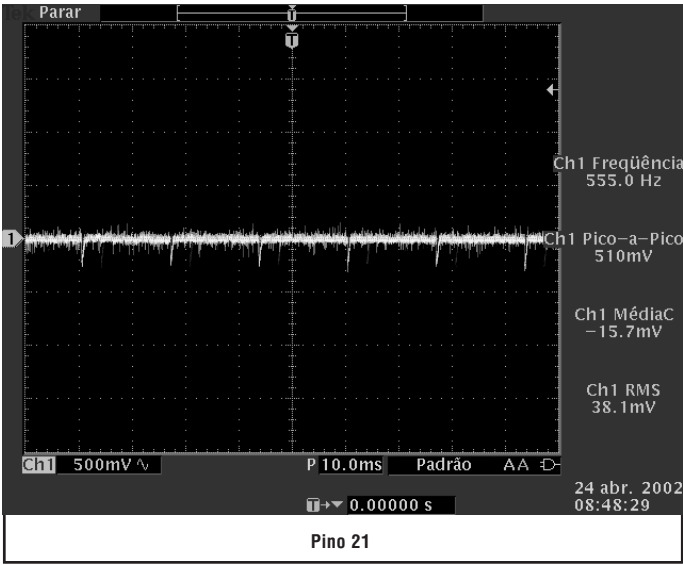



## IC601

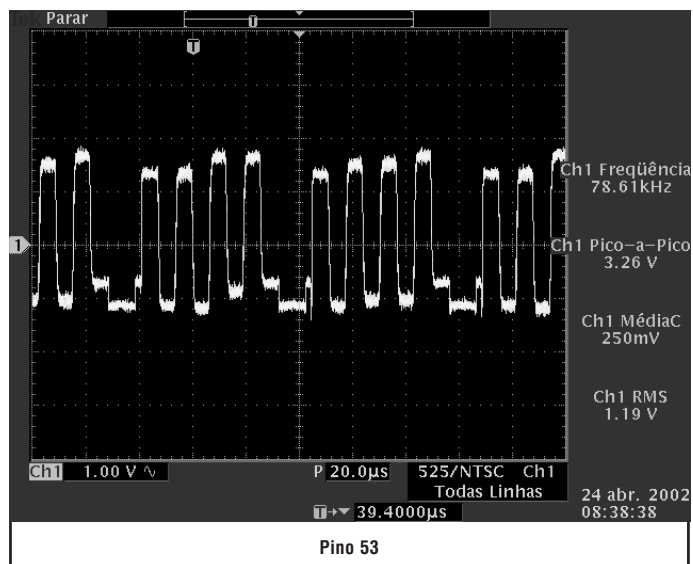
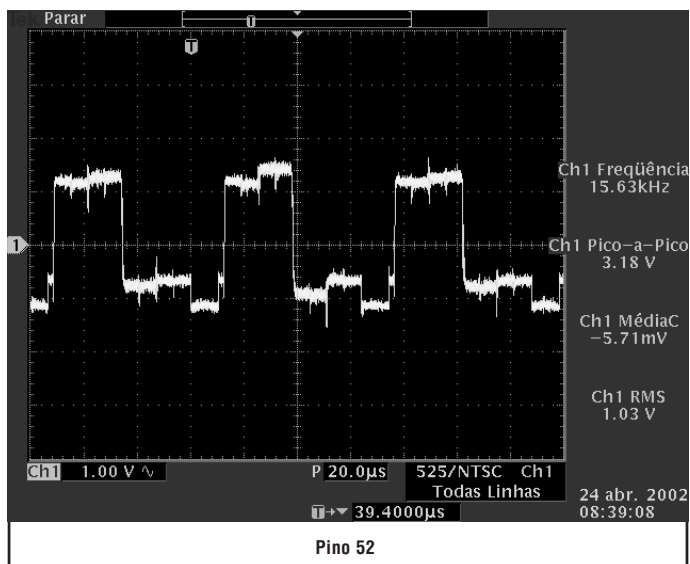
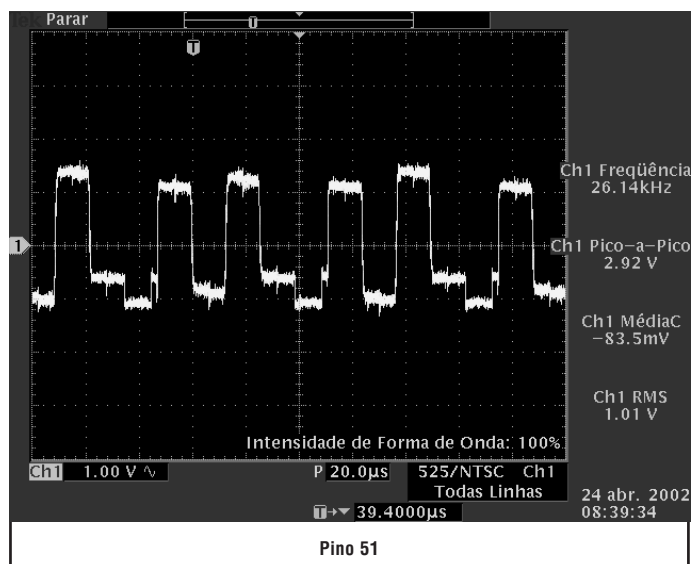
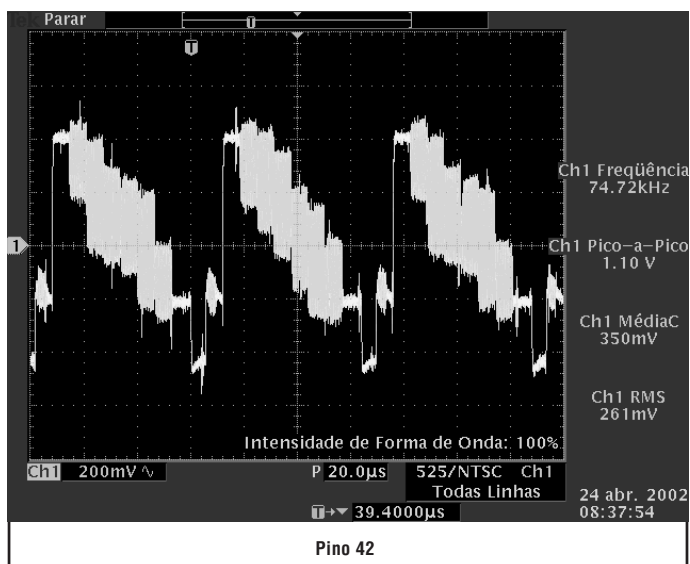

## TNR001

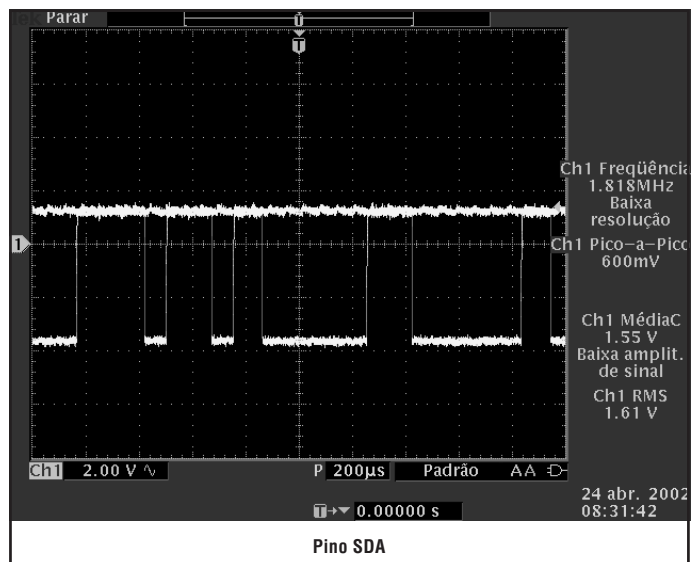
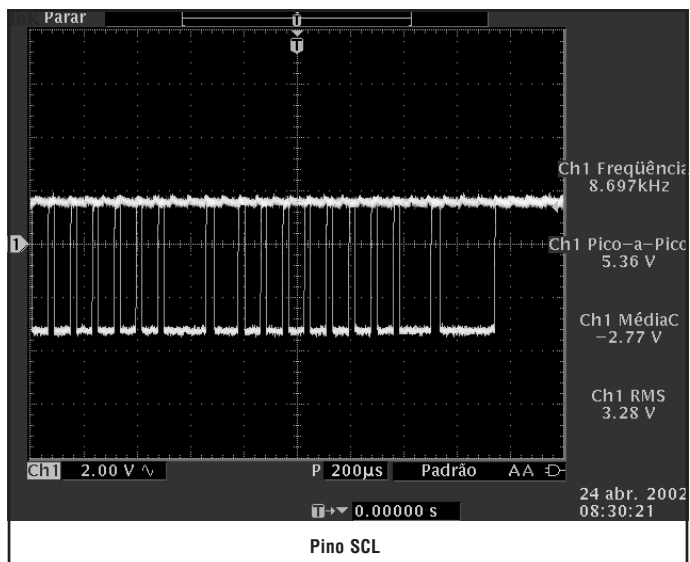

### IC801

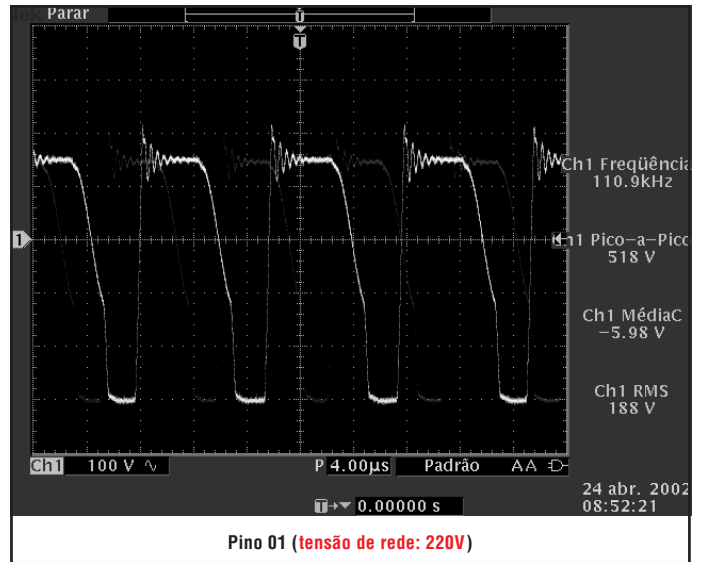
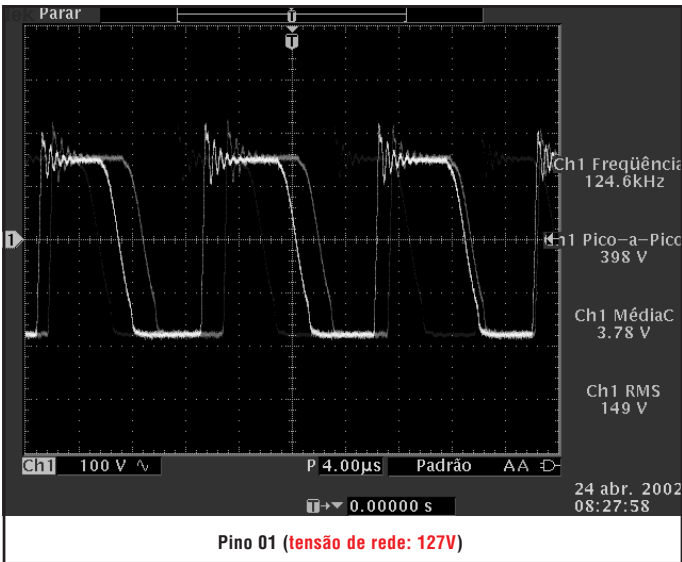

### IC451

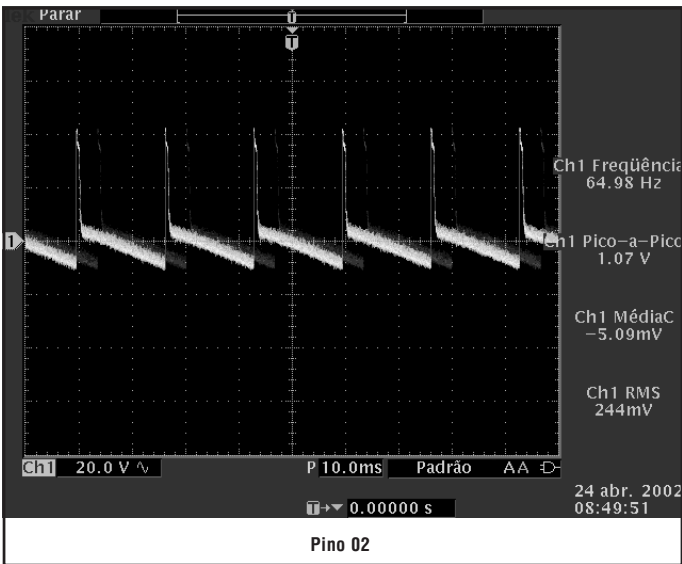

### X101

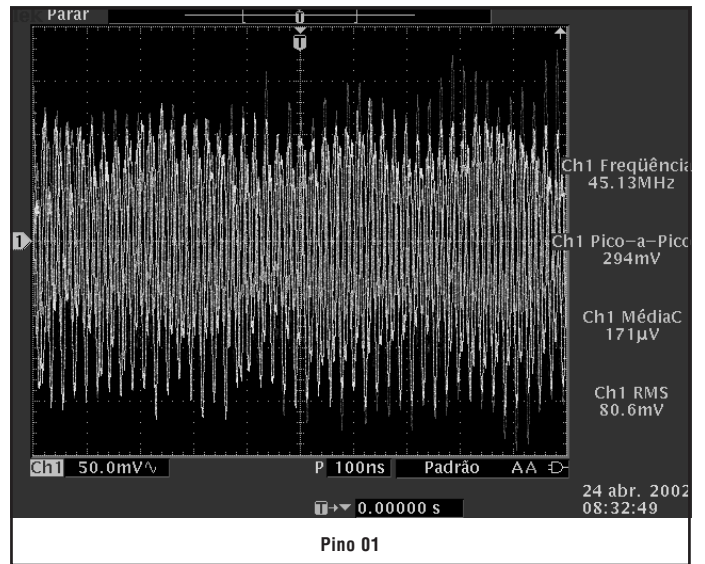

### Q501

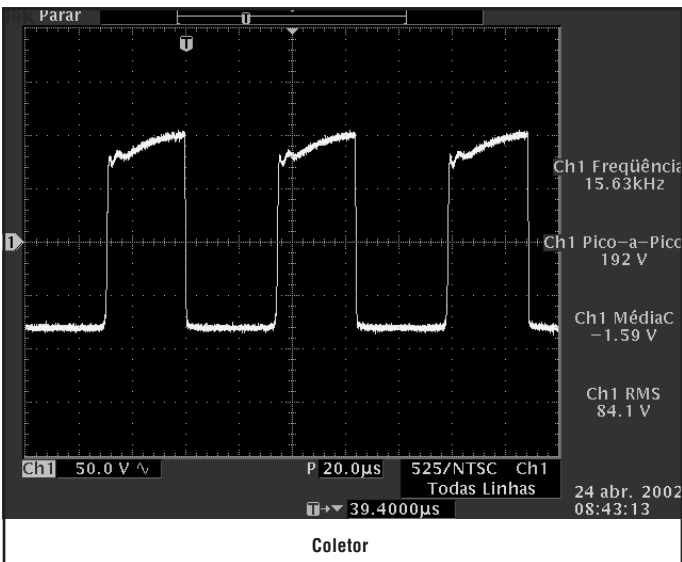

### Q551

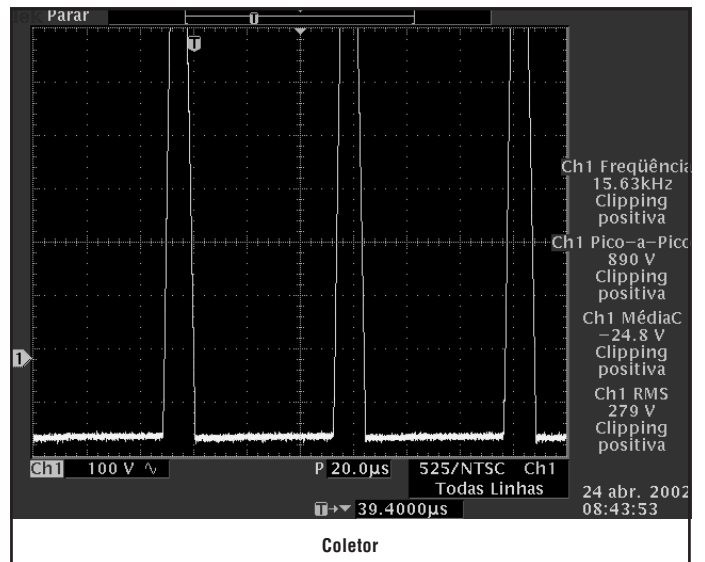

■ Parts Location

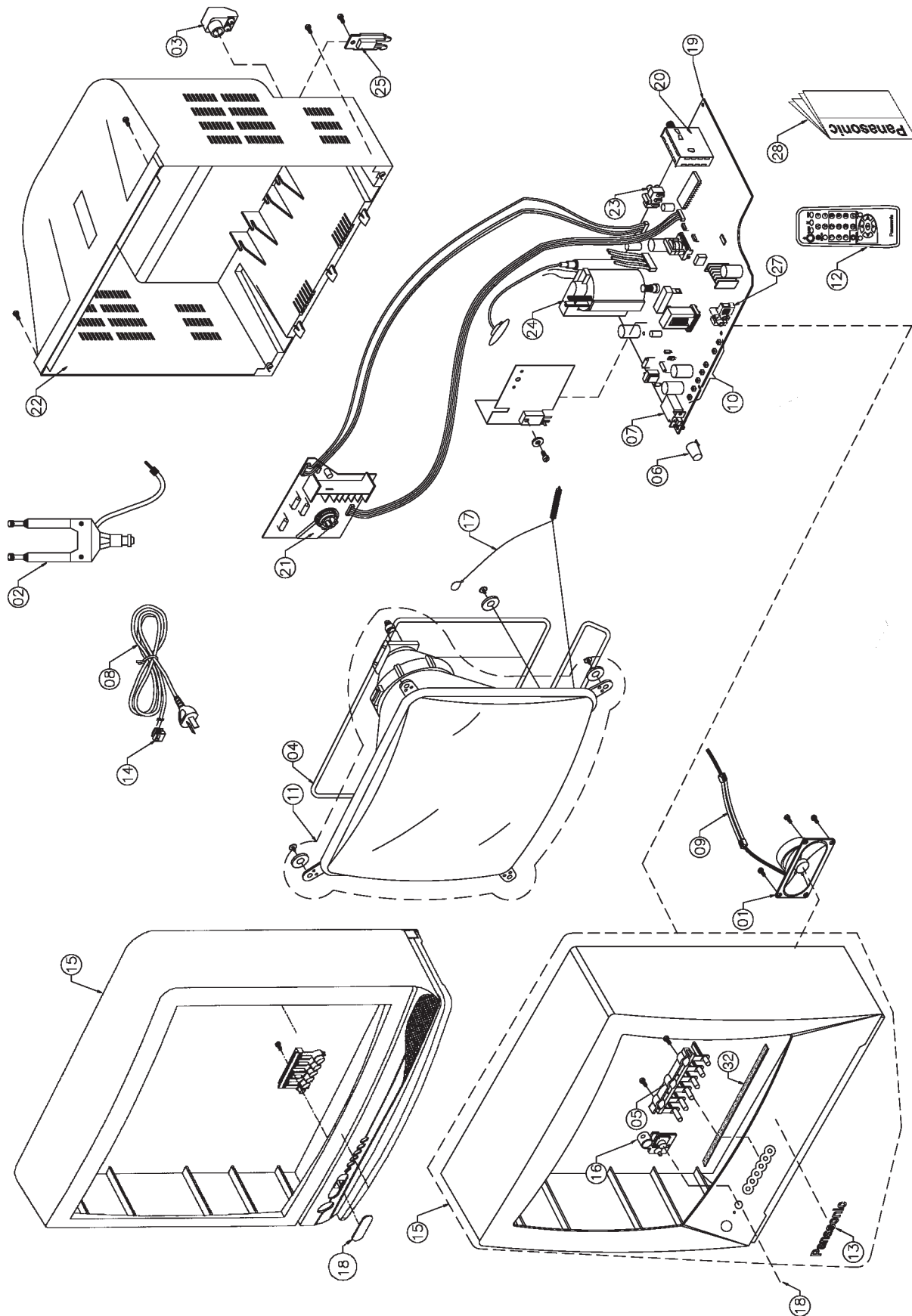

## ■ Packing and Accessories

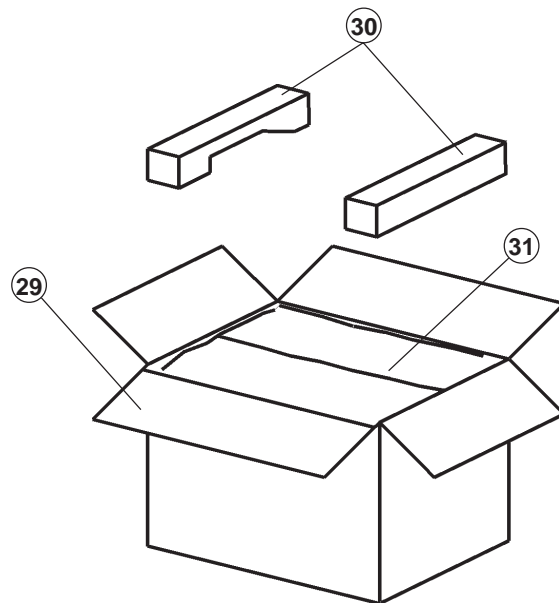

## ■ Replacement Mechanical Parts List

Ref.No.	TC-20B12	TC-14A12P	Description
01	EASZ9D03A8	EASZ9D03A8	SPEAKER 16Ω, 3W
02	TSA8108-6K	TSA8108-6K	TELESCOPIC ANTENNA
03	S-U5012	S-U5012	75Ω ADAPTOR
04	TLK2B20001A	TLK2B14001A	DEGAUSSING COIL
05	TBX2B864	TBX2B861-1	6 POSITIONS BUTTON
06	TBX2B846-1	TBX2B862-1	POWER BUTTON
07	ESB92DA1B	ESB92DA1B	POWER SWITCH
08	TSX2B1421SB	TSX2B1421SB	AC CABLE
09	TXAJTA22CB20A12	TXAJTA22CB14A12	2 WAY CONNECTOR (SPEAKER)
10	EVQ11G05R	EVQ11G05R	SWITCHES - S1001 ~ 1006
11	A48EAK01X094R	A34EAK01X094R	PICTURE TUBE
12	TNQ2B2901	TNQ2B2901	REMOTE CONTROLLER
13	TBM4G3003	TBM4G3008	PANASONIC BADGE
14	TMM2B202-1	TMM2B202-1	AC CABLE HOLDER
15	TXFKY20B12	TXFKY14A12P	ASSEMBLED CABINET
16	TKK2B0309	TKK2B0307	LED GUIDE
17	TXF3A20C7-1	TXF3A14C7	MALHA P/ ATERRAMENTO
18	TKP2B11191-2	TKP2B11221	LENS PANEL
19	TZGNPAL20B12	TZGNPAL14A12P	ASSEMBLED PCB
20	TEDH9-301A	TEDH9-301A	TUNER
21	330550044K2F	330620065	CRT SOCKET
22	TXITKU2B21403-5	TXITKU2B22301-1	REAR COVER
23	TJB16664	TJB16664	AV TERMINAL (JK3001)
24	KFT3AA428F	KFT2AA427F	FLY BACK
25	----- 0 -----	TKP2B11161-2	AC CABLE HOLDER ( CINZA )
26	TXPTKY2B1003-1	TXPTKY2B1801-1	CABINET
27	----- 0 -----	TJB4G605	AV TERMINAL (JK3101)
28	TQB2B0128	TQB2B0128	OPERATING INSTRUCTIONS
29	TPC2B4960	TPC2B1300	PACKING CASE PAPER
30	TPD2B735-1	TPD2B760	FILLERS
31	TPE2B4016	TPE2B4017	POLY BAG
32	----- 0 -----	TMK2B720	CUSHION

# Replacement Electrical Parts List

Ref. No.	TC-20B12	TC-20A12P	Description
<b>MAIN BOARD</b>			
	TZGNPAL20B12	TZGNPAL14A12P	ASSEMBLED PCB
<b>CAPACITORS</b>			
C001	ECEA1CKA220B	ECEA1CKA220B	CAP. ELETROL. 22 µF 16,0 V
C002	ECJ2VF1H104Z	ECJ2VF1H104Z	CAP. CER. SMD 100 nF 50,0 V
C005	ECJ2VF1H104Z	ECJ2VF1H104Z	CAP. CER. SMD 100 nF 50,0 V
C006	ECA1AM331B	ECA1AM331B	CAP. ELETROL. 330 µF 10,0 V
C008	ECEA1HKA010B	ECEA1HKA010B	CAP. ELETROL. 1 µF 50,0 V
C117	ECJ2VB1H103J	ECJ2VB1H103J	CAP. CER. SMD 10 nF 50,0 V
C354	ECJ2VC1H330J	ECJ2VC1H330J	CAP. CER. SMD 33 PF 50,0 V
C355	ECJ2VC1H330J	ECJ2VC1H330J	CAP. CER. SMD 33 PF 50,0 V
C356	ECJ2VC1H330J	ECJ2VC1H330J	CAP. CER. SMD 33 PF 50,0 V
C359	ECQM4104KZB	ECQM4104KZB	CAP. POLIÉSTER 100 nF 400,0 V
C368	ECJ2VC1H561J	ECJ2VC1H561J	CAP. CER. SMD 560 PF 50,0 V
C370	ECKW3D102KBP	ECKW3D102KBP	CAP. CER. 1 nF 2.000,0 V
C371	ECEA1CN100UB	ECEA1CN100UB	CAP. ELETROL. BIPOLAR 10 µF 16,0 V
C373	ECA2EM100B	ECA2EM100B	CAP. ELETROL. 10 µF 250,0 V
C377	ECA1CM221B	ECA1CM221B	CAP. ELETROL. 220 µF 16,0 V
C401	ECJ2VC1H222J	ECJ2VC1H222J	CAP. CER. SMD 2.200 PF 50,0 V
C402	ECA1VM222E	ECA1VM222E	CAP. ELETROL. 2.200 µF 35,0 V
C403	ECA1HM220B	ECA1HM220B	CAP. ELETROL. 22 µF 50,0 V
C406	ECA1HM101B	ECA1HM101B	CAP. ELETROL. 100 µF 50,0 V
C408	ECQV1H274JM3	ECQV1H274JM3	CAP. POLIÉSTER 270 nF 50,0 V
C409	ECA1HM330B	ECA1HM330B	CAP. ELETROL. 33 µF 50,0 V
C502	ECKR2H821KB5	ECKR2H821KB5	CAP. CER. 820 PF 500,0 V
C504	ECJ2VB1H681K	ECJ2VB1H681K	CAP. CER. SMD 680 PF 50,0 V
C506	ECCR2H100D5	ECCR2H100D5	CAP. CER. 10 PF 100,0 V
C511	ECA1VM101B	ECA1VM101B	CAP. ELETROL. 100 µF 35,0 V
C519	ECA160V33UE	ECA160V33UE	CAP. ELETROL. 33 µF 160,0 V
C520	ECA0JM221B	ECA0JM221B	CAP. ELETROL. 220 µF 6,3 V
C552	ECA2EM100B	ECA2EM100B	CAP. ELETROL. 10 µF 250,0 V
C555	ECKR2H471KB5	ECKR2H471KB5	CAP. CER. 470 PF 500,0 V
C558	ECA2CMR47B	ECA2CMR47B	CAP. ELETROL. 0,47 µF 160,0 V
C559	ECWH16822JVB	ECWH16822JVB	CAP. POLYPROPYLENE . 8,20 nF 1.600 V
C560	-----o-----	ECQM4273JZW	CAP. POLIÉSTER 27 nF 400,0 V
C560	ECQM4333JZ	-----o-----	CAP. POLIÉSTER 33 nF 400,0 V
C561	ECKW3D821JBN	-----o-----	CAP. CER. 820 PF 2.000,0 V
C561	-----o-----	ECKD3D221JBP	CAP. CER. 220 PF 2.000,0 V
C562	ECKW3D471JBN	-----o-----	CAP. CER. 470 PF 2.000,0 V
C562	-----o-----	ECKW3D681JBN	CAP. CER. 680 PF 2.000,0 V
C563	ECWF2394JSR	-----o-----	CAP. POLYPROPYLENE 390 nF 250,0 V
C563	-----o-----	ECWF2224JBB	CAP. POLYPROPYLENE 220 nF 250,0 V
C565	ECQP1H183JZ3	-----o-----	CAP. POLYPROPYLENE 18 nF 50,0 V
C565	-----o-----	ECQP1H223JZ3	CAP. POLYPROPYLENE 22 nF 50,0 V
C570	ECJ2VC1H560J	-----o-----	CAP. CER. SMD 56 PF 50,0 V
C570	-----o-----	ECJ2VC1H470J	CAP. CER. SMD 47 PF 50,0 V
C601	ECEA1CKA101B	ECEA1CKA101B	CAP. ELETROL. 100 µF 16,0 V
C602	ECJ2YB1H104K	ECJ2YB1H104K	CAP. CER. SMD 100 nF 50,0 V
C603	ECJ2VB1H472K	ECJ2VB1H472K	CAP. CER. SMD 470 PF 50,0 V
C604	ECQV1H224JM3	ECQV1H224JM3	CAP. POLIÉSTER 220 nF 50,0 V
C605	ECQV1H224JM3	ECQV1H224JM3	CAP. POLIÉSTER 220 nF 50,0 V
C606	ECJ2VC1H222J	ECJ2VC1H222J	CAP. CER. SMD 2.200 PF 50,0 V
C607	ECEA1HKA010B	ECEA1HKA010B	CAP. ELETROL. 1 µF 50,0 V
C608	ECEA1HKA2R2B	ECEA1HKA2R2B	CAP. ELETROL. 2,20 µF 50,0 V
C609	ECJ2YB1H104K	ECJ2YB1H104K	CAP. CER. SMD 100 nF 50,0 V
C610	ECJ2VB1H103J	ECJ2VB1H103J	CAP. CER. SMD 10 nF 50,0 V
C611	ECEA1HKAR22B	ECEA1HKAR22B	CAP. ELETROL. 0,22 µF 50,0 V
C612	ECJ2VB1H472K	ECJ2VB1H472K	CAP. CER. SMD 470 PF 50,0 V
C613	ECJ2VB1H472K	ECJ2VB1H472K	CAP. CER. SMD 470 PF 50,0 V
C614	ECQV1H104JM3	ECQV1H104JM3	CAP. POLIÉSTER 100 nF 50,0 V
C615	ECQV1H224JM3	ECQV1H224JM3	CAP. POLIÉSTER 220 nF 50,0 V
C616	ECJ2VB1H392K	ECJ2VB1H392K	CAP. CER. SMD 3.900 PF 50,0 V
C617	ECEA1CKA100B	ECEA1CKA100B	CAP. ELETROL. 10 µF 16,0 V
C618	ECKR1H681KB5	ECKR1H681KB5	CAP. CER. 680 PF 50,0 V
C620	ECJ2VC1H470J	ECJ2VC1H470J	CAP. CER. SMD 47 PF 50,0 V
C621	ECJ2VB1H471K	ECJ2VB1H471K	CAP. CER. SMD 470 PF 50,0 V
C622	ECJ2VF1H104Z	ECJ2VF1H104Z	CAP. CER. SMD 100 nF 50,0 V
C623	ECJ2VC1H270J	ECJ2VC1H270J	CAP. CER. SMD 27 PF 50,0 V
C624	ECEA1CKA100B	ECEA1CKA100B	CAP. ELETROL. 10 µF 16,0 V
C625	ECA0JM221B	ECA0JM221B	CAP. ELETROL. 220 µF 6,3 V

Ref. No.	TC-20B12	TC-20A12P	Description
C627	ECJ2YB1H473K	ECJ2YB1H473K	CAP. CER. SMD 47 nF 50,0 V
C628	ECJ2YB1H473K	ECJ2YB1H473K	CAP. CER. SMD 47 nF 50,0 V
C629	ECJ2YB1H104K	ECJ2YB1H104K	CAP. CER. SMD 100 nF 50,0 V
C631	ECJ2YB1H222K	ECJ2YB1H222K	CAP. CER. SMD 2.200 PF 50,0 V
C633	ECJ2VF1C105Z	ECJ2VF1C105Z	CAP. CER. SMD 1 µF 16,0 V
C634	ECJ2VF1C105Z	ECJ2VF1C105Z	CAP. CER. SMD 1 µF 16,0 V
C635	ECJ2VF1H104Z	ECJ2VF1H104Z	CAP. CER. SMD 100 nF 50,0 V
C636	ECEA1CKA101B	ECEA1CKA101B	CAP. ELETROL. 100 µF 16,0 V
C639	ECA1HM220B	ECA1HM220B	CAP. ELETROL. 22 µF 50,0 V
C641	ECJ2VC1H100C	ECJ2VC1H100C	CAP. CER. SMD 10 PF 50,0 V
C653	ECEA1CKA100B	ECEA1CKA100B	CAP. ELETROL. 10 µF 16,0 V
C660	ECQV1H105JM3	ECQV1H105JM3	CAP. POLIÉSTER 1 µF 50,0 V
C801	ECKCNA331MB7	ECKCNA331MB7	CAP. CER. 330 PF 4.000,0 V
C802	ECKCNA152ME7	ECKCNA152ME7	CAP. CER. 1,50 nF 4.000,0 V
C803	ECKWAE472ZE	ECKWAE472ZE	CAP. CER. 4,70 nF 250VAC
C805	ECQU2A224BN9	ECQU2A224BN9	CAP. POLYPROPYLENE 220 nF 100,0 V
C806	ECKWAE472ZE	ECKWAE472ZE	CAP. CER. 4,70 nF 250VAC
C807	ECKWAE472ZE	ECKWAE472ZE	CAP. CER. 4,70 nF 250VAC
C808	ECQB1H681JM3	ECQB1H681JM3	CAP. POLIÉSTER 680 PF 50,0 V
C809	ECKWAE472ZE	ECKWAE472ZE	CAP. CER. 4,70 nF 250VAC
C811	F2A1V330A085	F2A1V330A085	CAP. ELETROL. 33 µF 35,0 V
C813	ECKCNA332ME7	ECKCNA332ME7	CAP. CER. 3,30 nF 4.000,0 V
C814	ECKR1H471KB5	ECKR1H471KB5	CAP. CER. 470 PF 50,0 V
C815	ECQB1H392JM3	ECQB1H392JM3	CAP. POLIÉSTER 3,90 nF 50,0 V
C817	ECQU2A224BN9	ECQU2A224BN9	CAP. POLYPROPYLENE 220 nF 100,0 V
C818	ECKCNA331MB7	ECKCNA331MB7	CAP. CER. 330 PF 4.000,0 V
C820	ECKW3D122KBP	ECKW3D122KBP	CAP. CER. 1,20 nF 2.000,0 V
C821	ECKD3A472KBP	ECKD3A472KBP	CAP. CER. 4,70 nF 1.000,0 V
C824	F2B2G221A012	F2B2G221A012	CAP. ELETROL. 220 µF 400,0 V
C831	ECKR3A271KBP	ECKR3A271KBP	CAP. CER. 270 PF 1.000,0 V
C832	F2A1C471A116	F2A1C471A116	CAP. ELETROL. 470 µF 16,0 V
C840	ECJ2YB1C474K	ECJ2YB1C474K	CAP. CER. SMD 470 nF 16,0 V
C841	ECJ2YB1A824K	ECJ2YB1A824K	CAP. CER. SMD 820 nF 10,0 V
C851	ECJ2VF1C105Z	ECJ2VF1C105Z	CAP. CER. SMD 1 µF 16,0 V
C853	ECKR2H151KB5	ECKR2H151KB5	CAP. CER. 150 PF 500,0 V
C855	ECJ2VF1C105Z	ECJ2VF1C105Z	CAP. CER. SMD 1 µF 16,0 V
C856	ECKR2H151KB5	ECKR2H151KB5	CAP. CER. 150 PF 500,0 V
C857	ECA1CM471B	ECA1CM471B	CAP. ELETROL. 470 µF 16,0 V
C859	F2A1V681A096	F2A1V681A096	CAP. ELETROL. 680 µF 35,0 V
C861	ECA1VM102E	ECA1VM102E	CAP. ELETROL. 1.000 µF 35,0 V
C861	ECA1VM102B	ECA1VM102B	CAP. ELETROL. 1.000 µF 35,0 V
C862	ECEA1VKA100B	ECEA1VKA100B	CAP. ELETROL. 10 µF 35,0 V
C863	ECKR2H271KB5	ECKR2H271KB5	CAP. CER. 270 PF 500,0 V
C865	F2A2C680A021	F2A2C680A021	CAP. ELETROL. 68 µF 160,0 V
C866	ECKW3D221JBP	ECKW3D221JBP	CAP. CER. 220 PF 2.000,0 V
C971	ECJ2VF1H103Z	ECJ2VF1H103Z	CAP. CER. SMD 10 nF 50,0 V
C1101	ECJ2VF1H104Z	ECJ2VF1H104Z	CAP. CER. SMD 100 nF 50,0 V
C1103	ECJ2VC1H331J	ECJ2VC1H331J	CAP. CER. SMD 330 PF 50,0 V
C1104	ECA1CM101B	ECA1CM101B	CAP. ELETROL. 100 µF 16,0 V
C1105	ECJ2VF1H104Z	ECJ2VF1H104Z	CAP. CER. SMD 100 nF 50,0 V
C1106	ECJ2VF1H104Z	ECJ2VF1H104Z	CAP. CER. SMD 100 nF 50,0 V
C1120	ECA1HM4R7B	ECA1HM4R7B	CAP. ELETROL. 4,70 µF 50,0 V
C1130	ECJ2VC1H560J	ECJ2VC1H560J	CAP. CER. SMD 56 PF 50,0 V
C1131	ECA0JM221B	ECA0JM221B	CAP. ELETROL. 220 µF 6,3 V
C1132	ECJ2VC1H560J	ECJ2VC1H560J	CAP. CER. SMD 56 PF 50,0 V
C1203	ECJ2VF1H104Z	ECJ2VF1H104Z	CAP. CER. SMD 100 nF 50,0 V
C1204	ECEA1CKA101B	ECEA1CKA101B	CAP. ELETROL. 100 µF 16,0 V
C1205	ECA1CM101B	ECA1CM101B	CAP. ELETROL. 100 µF 16,0 V
C2301	ECJ2VB1H103K	ECJ2VB1H103K	CAP. CER. SMD 10 nF 50,0 V
C2302	ECA1CM100B	ECA1CM100B	CAP. ELETROL. 10 µF 16,0 V
C2305	ECA1CM100B	ECA1CM100B	CAP. ELETROL. 10 µF 16,0 V
C2306	ECA1CM470B	ECA1CM470B	CAP. ELETROL. 47 µF 16,0 V
C2307	ECA1VM102E	ECA1VM102E	CAP. ELETROL. 1.000 µF 35,0 V
C2307	ECA1VM102B	ECA1VM102B	CAP. ELETROL. 1.000 µF 35,0 V
C2308	ECJ2VF1H103Z	ECJ2VF1H103Z	CAP. CER. SMD 10 nF 50,0 V
C2309	ECA1EM471B	ECA1EM471B	CAP. ELETROL. 470 µF 25,0 V
C2310	ECQV1H224JM3	ECQV1H224JM3	CAP. POLIÉSTER 220 nF 50,0 V
C2311	ECQV1H224JM3	ECQV1H224JM3	CAP. POLIÉSTER 220 nF 50,0 V
C2312	ECA1VM470B	ECA1VM470B	CAP. ELETROL. 47 µF 35,0 V
C2313	ECA1HM3R3B	ECA1HM3R3B	CAP. ELETROL. 3,30 µF 50,0 V

Ref. No.	TC-20B12	TC-20A12P	Description
C2380	ECA1CM101B	ECA1CM101B	CAP. ELETROL. 100 µF 16,0 V
C3111	ECJ2VC1H561K	ECJ2VC1H561K	CAP. CER. SMD 560 PF 50,0 V
C3113	ECJ2VC1H561K	ECJ2VC1H561K	CAP. CER. SMD 560 PF 50,0 V
C3116	ECJ2VB1H103J		CAP. CER. SMD 10 nF 50,0 V
C3117	ECJ2VB1H103J		CAP. CER. SMD 10 nF 50,0 V
<b>DIODES</b>			
D002	MTZJT-7716A	MTZJT-7716A	DIODO ZENER 16,0 V 1/2 W 5,0 mA
D003	MTZJT-7716A	MTZJT-7716A	DIODO ZENER 16,0 V 1/2 W 5,0 mA
D004	MTZJT-7730D	MTZJT-7730D	DIODO ZENER 30,0 V 0,5 W 5,0 mA
D005	MTZJT-7730D	MTZJT-7730D	DIODO ZENER 30,0 V 0,5 W 5,0 mA
D354	MA152KTX	MA152KTX	DIODO CHAVEAMENTO SMD
D355	MA152KTX	MA152KTX	DIODO CHAVEAMENTO SMD
D356	MA152KTX	MA152KTX	DIODO CHAVEAMENTO SMD
D360	ERA2204V3	ERA2204V3	DIODO CHAVEAMENTO
D361	ERA2204V3	ERA2204V3	DIODO CHAVEAMENTO
D362	ERA2204V3	ERA2204V3	DIODO CHAVEAMENTO
D363	MA152KTX	MA152KTX	DIODO CHAVEAMENTO SMD
D365	MTZJT-7710C	MTZJT-7710C	DIODO ZENER 9,9 V 0,5 W 5,0 mA
D375	MA152KTX	MA152KTX	DIODO CHAVEAMENTO SMD
D402	D1NF60V70	D1NF60V70	DIODO RETIFICADOR
D403	MTZJT-7733B	MTZJT-7733B	DIODO ZENER 33,0 V 1/2 W 5,0 mA
D511	MA4108JTA	MA4108JTA	DIODO ZENER 10,8 V 0,37 W
D512	MA171TA5	MA171TA5	DIODO CHAVEAMENTO
D520	MA152KTX	MA152KTX	DIODO CHAVEAMENTO SMD
D551	MA3047HTX	MA3047HTX	DIODO ZENER SMD 4,7 V 1/10 W
D552	D1NF60V70	D1NF60V70	DIODO RETIFICADOR
D555	MA152KTX	MA152KTX	DIODO CHAVEAMENTO SMD
D556	ERB06-15V1	ERB06-15V1	DIODO RETIFICADOR
D557	RU2AMV1	RU2AMV1	DIODO CHAVEAMENTO
D558	MA185TA5	MA185TA5	DIODO CHAVEAMENTO
D603	MA152KTX	MA152KTX	DIODO CHAVEAMENTO SMD
D606	MA152KTX	MA152KTX	DIODO CHAVEAMENTO SMD
D630	MA3056HTX	MA3056HTX	DIODO ZENER SMD 5,8 V 1/10 W
D660	MA152WKTX	MA152WKTX	DIODO CHAVEAMENTO SMD
D801	TAP2B0001	TAP2B0001	POSISTOR 7 Ω
D802	D4SB80	D4SB80	DIODO RETIFICADOR
D804	AG01ZV0	AG01ZV0	DIODO RETIFICADOR
D805	AG01ZV0	AG01ZV0	DIODO RETIFICADOR
D806	ERZV10V621CS	ERZV10V621CS	VARISTOR
D807	TLP721FD4GR-BR	TLP721FD4GR-BR	PHOTO ACOPLADOR
D808	MTZJT-7712B	MTZJT-7712B	DIODO ZENER 12,0 V 1/2 W
D811	AM01AV1	AM01AV1	DIODO RETIFICADOR
D814	MA182TA5	MA182TA5	DIODO CHAVEAMENTO
D816	AG01ZV0	AG01ZV0	DIODO RETIFICADOR
D820	ERA22-10G1	ERA22-10G1	DIODO CHAVEAMENTO
D824	MA4068MTA	MA4068MTA	DIODO ZENER 6,8 V 1/4 W
D831	RU4AMLF-M1	RU4AMLF-M1	DIODO CHAVEAMENTO
D837	S3L60P1520	S3L60P1520	DIODO CHAVEAMENTO
D855	AG01ZV0	AG01ZV0	DIODO RETIFICADOR
D856	RN1ZLF-A1	RN1ZLF-A1	DIODO CHAVEAMENTO
D862	MTZJT-7710A	MTZJT-7710A	DIODO ZENER 9,6 V 1/2 W 5,0 mA
D865	MTZJT-7724B	MTZJT-7724B	DIODO ZENER 24,0 V 1/2 W 5,0 mA
D1101	MA152KTX	MA152KTX	DIODO CHAVEAMENTO SMD
D1102	MTZJT-775.6A	MTZJT-775.6A	DIODO ZENER 5,4 V 1/2 W 5,0 mA
D1104	EL333ID/S928	EL333ID/S928	DIODO LED
D1104	TMW2B210	TMW2B210	SUPORTE DO LED
D1105	MTZJT-777.5C	MTZJT-777.5C	DIODO ZENER 7,5 V 1/2 W
D1130	MTZJT-775.6C	MTZJT-775.6C	DIODO ZENER 5,7 V 0,5 W
D1131	MTZJT-775.6C	MTZJT-775.6C	DIODO ZENER 5,7 V 0,5 W
D1204	MTZJT-775.6B	MTZJT-775.6B	DIODO ZENER 5,6 V 0,5 W 5,0 mA
D2320	MA152KTX	MA152KTX	DIODO CHAVEAMENTO SMD
D2380	MA152KTX	MA152KTX	DIODO CHAVEAMENTO SMD
D2381	MA152KTX	MA152KTX	DIODO CHAVEAMENTO SMD
<b>FUSE</b>			
F801	XBA2C40TRO	XBA2C40TRO	FUSIVEL 4A 250V
<b>INTEGRATED CIRCUITS</b>			
IC351	TDA6107Q/N2	TDA6107Q/N2	CIRCUITO INTEGRADO
IC451	AN5539	AN5539	CIRCUITO INTEGRADO
IC601	TDA9381PS/N2/3H	TDA9381PS/N2/3H	MICROCONTROLLER
IC801	STRW6654LF02	STRW6654LF02	CI REGULADOR DE TENSÃO
IC802	SE140N	SE140N	CI DETECTOR DE VOLTAGEM=10V
IC851	AN7805LB	AN7805LB	IC REGULADOR DE VOLTAGEM 4 V

Ref. No.	TC-20B12	TC-20A12P	Description
IC852	AN78M08LB	AN78M08LB	IC - REGULADOR DE VOLTAGEM
IC1103	BR24C08F-E2	BR24C08F-E2	CI SMD MEMORIA EEPROM 8K
IC1104	GP1U282Q	GP1U282Q	GP1U282Q
IC1201	PQ1R33	PQ1R33	CIRCUITO INTEGRADO SMD REG.3V
IC1202	AN7805LB	AN7805LB	IC REGULADOR DE VOLTAGEM 4 V
IC2301	LA4289N	LA4289N	CIRCUITO INTEGRADO SAÍDA DE AUDIO
<b>JUMPERS</b>			
JA2	ERJ3GEY0R00V	ERJ3GEY0R00V	RES. METALIC FILM SMD 0 Ω
JA3	ERJ3GEY0R00V	ERJ3GEY0R00V	RES. METALIC FILM SMD 0 Ω
JA4	ERJ3GEY0R00V	ERJ3GEY0R00V	RES. METALIC FILM SMD 0 Ω
JA5	ERJ3GEY0R00V	ERJ3GEY0R00V	RES. METALIC FILM SMD 0 Ω
JA7	ERJ3GEY0R00V	ERJ3GEY0R00V	RES. METALIC FILM SMD 0 Ω
JA8	ERJ3GEY0R00V	ERJ3GEY0R00V	RES. METALIC FILM SMD 0 Ω
JA9	ERJ3GEY0R00V	ERJ3GEY0R00V	RES. METALIC FILM SMD 0 Ω
JA10	ERJ3GEY0R00V	ERJ3GEY0R00V	RES. METALIC FILM SMD 0 Ω
JA11	ERJ3GEY0R00V	ERJ3GEY0R00V	RES. METALIC FILM SMD 0 Ω
JA12	ERJ3GEY0R00V	-----	RES. METALIC FILM SMD 0 Ω
JA14	ERJ3GEY0R00V	ERJ3GEY0R00V	RES. METALIC FILM SMD 0 Ω
JA15	ERJ3GEY0R00V	ERJ3GEY0R00V	RES. METALIC FILM SMD 0 Ω
JA16	ERJ3GEY0R00V	ERJ3GEY0R00V	RES. METALIC FILM SMD 0 Ω
JA17	ERJ3GEY0R00V	ERJ3GEY0R00V	RES. METALIC FILM SMD 0 Ω
JA18	ERJ3GEY0R00V	ERJ3GEY0R00V	RES. METALIC FILM SMD 0 Ω
JA20	ERJ3GEY0R00V	ERJ3GEY0R00V	RES. METALIC FILM SMD 0 Ω
JA25	ERJ3GEY0R00V	ERJ3GEY0R00V	RES. METALIC FILM SMD 0 Ω
JA27	ERJ3GEY0R00V	ERJ3GEY0R00V	RES. METALIC FILM SMD 0 Ω
JA30	ERJ3GEY0R00V	ERJ3GEY0R00V	RES. METALIC FILM SMD 0 Ω
JA31	ERJ3GEY0R00V	ERJ3GEY0R00V	RES. METALIC FILM SMD 0 Ω
JA32	ERJ3GEY0R00V	ERJ3GEY0R00V	RES. METALIC FILM SMD 0 Ω
JA33	ERJ3GEY0R00V	ERJ3GEY0R00V	RES. METALIC FILM SMD 0 Ω
JS002	ERJ3GEY0R00V	ERJ3GEY0R00V	RES. METALIC FILM SMD 0 Ω
JS2302	ERJ3GEY0R00V	ERJ3GEY0R00V	RES. METALIC FILM SMD 0 Ω
JS2310	ERJ3GEY0R00V	ERJ3GEY0R00V	RES. METALIC FILM SMD 0 Ω
JS3012	ERJ3GEY0R00V	ERJ3GEY0R00V	RES. METALIC FILM SMD 0 Ω
JS3130	ERJ3GEY0R00V	ERJ3GEY0R00V	RES. METALIC FILM SMD 0 Ω
JS3132	ERJ3GEY0R00V	ERJ3GEY0R00V	RES. METALIC FILM SMD 0 Ω
JS3136	-----	ERJ3GEY0R00V	RES. METALIC FILM SMD 0 Ω
JS3137	-----	ERJ3GEY0R00V	RES. METALIC FILM SMD 0 Ω
JS551	ERJ3GEY0R00V	ERJ3GEY0R00V	RES. METALIC FILM SMD 0 Ω
JS554	ERJ3GEY0R00V	ERJ3GEY0R00V	RES. METALIC FILM SMD 0 Ω
JS557	ERJ3GEY0R00V	ERJ3GEY0R00V	RES. METALIC FILM SMD 0 Ω
JS558	ERJ3GEY0R00V	ERJ3GEY0R00V	RES. METALIC FILM SMD 0 Ω
JS601	ERJ3GEY0R00V	ERJ3GEY0R00V	RES. METALIC FILM SMD 0 Ω
JS628	ERJ3GEY0R00V	ERJ3GEY0R00V	RES. METALIC FILM SMD 0 Ω
JS629	ERJ3GEY0R00V	ERJ3GEY0R00V	RES. METALIC FILM SMD 0 Ω
JS630	ERJ3GEY0R00V	ERJ3GEY0R00V	RES. METALIC FILM SMD 0 Ω
JS678	ERJ3GEY0R00V	ERJ3GEY0R00V	RES. METALIC FILM SMD 0 Ω
JS680	ERJ3GEY0R00V	ERJ3GEY0R00V	RES. METALIC FILM SMD 0 Ω
JS850	ERJ3GEY0R00V	ERJ3GEY0R00V	RES. METALIC FILM SMD 0 Ω
JS871	ERJ3GEY0R00V	ERJ3GEY0R00V	RES. METALIC FILM SMD 0 Ω
<b>COILS</b>			
L001	TALV35VB100K	TALV35VB100K	BOBINA DE PICO 10 µH
L181	TALV35VB6R8K	TALV35VB6R8K	BOBINA DE PICO 6,80 µH
L352	EXCELSA24T	EXCELSA24T	FERRITE Z=20 Ω(100MHZ)
L501	ELH5L4115	-----	BOBINA LINEARIDADE
L501	ELH5LZ43Z	-----	BOBINA DE LINEARIDADE 50,50 µH
L550	TSKA125	TSKA125	BEAD CORE SMD
L560	EXCELD35V	EXCELD35V	BOBINA DE PICO Z=80 Ω(100MHZ)
L619	TSK1045	TSK1045	BEAD CORE SMD
L620	TSK1045	TSK1045	BEAD CORE SMD
L621	EXCELSA39V	EXCELSA39V	FERRITE Z=80 Ω(100MHZ)
L801	ELF21V012A	ELF21V012A	FILTRO DE LINHA
L820	EXCELD35C	EXCELD35C	BOBINA DE PICO Z= 80 Ω(100 MHZ)
L852	TALL08N101KA	TALL08N101KA	BOBINA DE PICO 100 µH
L856	TALV35VB1R5K	TALV35VB1R5K	BOBINA DE PICO 1,50 µH
L857	TALV35VB1R5K	TALV35VB1R5K	BOBINA DE PICO 1,50 µH
L1101	TALV35VB331K	TALV35VB331K	BOBINA DE PICO 330 µH
<b>TRANSISTORS</b>			
Q369	2SA1235A-T12	2SA1235A-T12	TRANSISTOR SMD
Q401	2SA1235A-T12	2SA1235A-T12	TRANSISTOR SMD
Q445	2SC3326ATX	2SC3326ATX	TRANSISTOR SMD NPN 0,1 W
Q446	2SC3052-T12	2SC3052-T12	TRANSISTOR SMD NPN 0,1 W
Q447	2SC3052-T12	2SC3052-T12	TRANSISTOR SMD NPN 0,1 W



Ref. No.	TC-20B12	TC-20A12P	Description
Q501	2SC4212HLB	2SC4212HLB	TRANSISTOR DE POTÊNCIA NPN
Q520	2SB792ATX	2SB792ATX	TRANSISTOR SMD PNP 0,2 W
Q551	2SD2539LB306	2SD2539LB306	TRANSISTOR DE POTENCIA
Q601	2SA1235A-T12	2SA1235A-T12	TRANSISTOR SMD
Q602	2SC3052-T12	2SC3052-T12	TRANSISTOR SMD NPN 0,1 W
Q603	2SA1235A-T12	2SA1235A-T12	TRANSISTOR SMD
Q605	2SC3052-T12	2SC3052-T12	TRANSISTOR SMD NPN 0,1 W
Q606	2SC3052-T12	2SC3052-T12	TRANSISTOR SMD NPN 0,1 W
Q852	2SC3052-T12	2SC3052-T12	TRANSISTOR SMD NPN 0,1 W
Q857	2SC3052-T12	2SC3052-T12	TRANSISTOR SMD NPN 0,1 W
Q1101	2SC3052-T12	2SC3052-T12	TRANSISTOR SMD NPN 0,1 W
Q2320	2SA1235A-T12	2SA1235A-T12	TRANSISTOR SMD
Q2380	2SC3052-T12	2SC3052-T12	TRANSISTOR SMD NPN 0,1 W
Q2381	2SA1235A-T12	2SA1235A-T12	TRANSISTOR SMD
<b>RESISTORS</b>			
R003	ERJ3GEYJ100V	ERJ3GEYJ100V	RES. METALIC FILM SMD 10 Ω 1/10 W
R004	ERG3FJ822H	ERG3FJ822H	RES. METALIC FILM 8,20 kΩ
R006	ERJ3GEYJ273V	ERJ3GEYJ273V	RES. METALIC FILM SMD 27 kΩ 1/10 W
R007	ERJ3GEYJ472V	ERJ3GEYJ472V	RES. METALIC FILM SMD 4,70 kΩ 1/10 W
R008	ERJ3GEYJ681V	ERJ3GEYJ681V	RES. METALIC FILM SMD 680 Ω 1/10 W
R182	ERJ3GEYJ221V	ERJ3GEYJ221V	RES. METALIC FILM SMD 220 Ω 1/10 W
R351	ERJ3EKF1001V	ERJ3EKF1001V	RES. METALIC FILM SMD 1 kΩ 1/16 W
R352	ERJ3EKF1001V	ERJ3EKF1001V	RES. METALIC FILM SMD 1 kΩ 1/16 W
R353	ERJ3EKF1001V	ERJ3EKF1001V	RES. METALIC FILM SMD 1 kΩ 1/16 W
R354	ERJ3EKF7870V	ERJ3EKF7870V	RES. METALIC FILM SMD 787 Ω 1/16 W
R355	ERJ3EKF7870V	ERJ3EKF7870V	RES. METALIC FILM SMD 787 Ω 1/16 W
R356	ERJ3EKF7870V	ERJ3EKF7870V	RES. METALIC FILM SMD 787 Ω 1/16 W
R363	ERC12GK222V	ERC12GK222V	RES. CARBONO 2,20 kΩ 1/2 W
R364	ERC12GK222V	ERC12GK222V	RES. CARBONO 2,20 kΩ 1/2 W
R365	ERC12GK222V	ERC12GK222V	RES. CARBONO 2,20 kΩ 1/2 W
R369	ERJ3GEYJ103V	ERJ3GEYJ103V	RES. METALIC FILM SMD 10 kΩ 1/10 W
R374	ERQ12AJ181P	ERQ12AJ181P	FUSISTOR 180 Ω 1/2 W
R401	ERDS2TJ1R5T	---- o ----	RES. CARBONO 1,50 Ω 1/4 W
R401	---- o ----	ERDS2TJ1R8T	RES. CARBONO 1,80 Ω 1/4 W
R402	ERJ3GEYJ103V	ERJ3GEYJ103V	RES. METALIC FILM SMD 10 kΩ 1/10 W
R403	ERJ3GEYJ182V	---- o ----	RES. METALIC FILM SMD 1,80 kΩ 1/10 W
R403	---- o ----	ERJ3GEYJ332V	RES. METALIC FILM SMD 3,30 kΩ 1/10 W
R404	ERJ3EKF2701V	ERJ3EKF2701V	RES. METALIC FILM SMD 2,70 kΩ 1/16 W
R405	ERJ3GEYJ222V	---- o ----	RES. METALIC FILM SMD 2,20 kΩ 1/10 W
R405	---- o ----	ERJ3GEYJ272V	RES. METALIC FILM SMD 2,70 kΩ 1/10 W
R406	ERJ3GEYJ1R0V	ERJ3GEYJ1R0V	RES. METALIC FILM SMD 1 Ω 1/10 W
R407	ERDS1TJ331T	---- o ----	RES. CARBONO 330 Ω 0,5 1/2 W
R407	---- o ----	ERDS1TJ221T	RES. CARBONO 220 Ω 1/2 W
R408	ERJ3GEYOR00V	ERJ3GEYOR00V	RES. METALIC FILM SMD 0 Ω
R409	ERJ3GEYJ823V	ERJ3GEYJ823V	RES. METALIC FILM SMD 82 kΩ 1/10 W
R411	ERJ3GEYJ182V	---- o ----	RES. METALIC FILM SMD 1,80 kΩ 1/10 W
R411	---- o ----	ERJ3GEYJ472V	RES. METALIC FILM SMD 4,70 kΩ 1/10 W
R412	ERJ3GEYJ332V	---- o ----	RES. METALIC FILM SMD 3,30 kΩ 1/10 W
R412	---- o ----	ERJ3GEYJ562V	RES. METALIC FILM SMD 5,60 kΩ 1/10 W
R415	ERJ3GEYJ431V	---- o ----	RES. METALIC FILM SMD 430 Ω 1/10 W
R415	---- o ----	ERJ3GEYJ621V	RES. METALIC FILM SMD 620 Ω 1/10 W
R416	ERDS1TJ1R0T	ERDS1TJ1R0T	RES. CARBONO 1 Ω 1/2 W
R417	ERDS1TJ1R0T	---- o ----	RES. CARBONO 1 Ω 1/2 W
R420	ERDS2TJ562T	ERDS2TJ562T	RES. CARBONO 5,60 kΩ 1/4 W
R443	ERDS1TJ152T	---- o ----	RES. CARBONO 1,50 kΩ 1/2 W
R443	---- o ----	ERDS1TJ132T	RES. CARBONO 1,30 kΩ 1/2 W
R444	ERG1SJ182E	ERG1SJ182E	RES. METALIC FILM 1,80 kΩ
R445	ERJ3GEYJ473V	ERJ3GEYJ473V	RES. METALIC FILM SMD 47 kΩ 1/10 W
R446	ERJ3GEYJ473V	ERJ3GEYJ473V	RES. METALIC FILM SMD 47 kΩ 1/10 W
R447	ERJ3GEYJ472V	ERJ3GEYJ472V	RES. METALIC FILM SMD 4,70 kΩ 1/10 W
R448	ERJ3GEYJ242V	ERJ3GEYJ242V	RES. METALIC FILM SMD 2,40 Ω 1/10 W
R449	ERJ3GEYJ152V	ERJ3GEYJ152V	RES. METALIC FILM SMD 1,50 kΩ 1/10 W
R502	ERJ3GEYJ182V	ERJ3GEYJ182V	RES. METALIC FILM SMD 1,80 kΩ 1/10 W
R503	ERJ3GEYOR00V	ERJ3GEYOR00V	RES. METALIC FILM SMD 0 Ω
R504	ERG2SJ682E	ERG2SJ682E	RES. METALIC FILM 6,80 kΩ
R507	ERJ3GEYJ101V	ERJ3GEYJ101V	RES. METALIC FILM SMD 100 Ω 1/10 W
R508	ERG3FJ102H	---- o ----	RES. METALIC FILM 1 kΩ 3 W
R508	---- o ----	ERG3FJ182H	RES. METALIC FILM 1,80 kΩ 3 W
R509	---- o ----	ERG3FJ182H	RES. METALIC FILM 1,80 kΩ 3 W
R509	ERG3FJ122H	---- o ----	RES. METALIC FILM 1,20 kΩ 3 W
R511	ERJ6ENF1801V	---- o ----	RES. METALIC FILM SMD 1,80 kΩ 1/10 W
R511	---- o ----	ERJ6ENF1201V	RES. METALIC FILM SMD 1,20 kΩ 1/10 W

Ref. No.	TC-20B12	TC-20A12P	Description
R512	ERJ6ENF1911V	---- o ----	RES. METALIC FILM SMD 1,91 kΩ 1/10 W
R512	---- o ----	ERJ6ENF1101V	RES. METALIC FILM SMD 1,10 kΩ 1/10 W
R513	ERQ14AJ100P	ERQ14AJ100P	FUSISTOR 10 Ω 1/4 W
R520	ERX12SJ3R0E	---- o ----	RES. METALIC FILM 3 Ω 1/2 W
R520	---- o ----	ERX12SJ3R3E	RES. METALIC FILM 3,30 Ω 1/2 W
R521	ERX12SJ3R0E	---- o ----	RES. METALIC FILM 3 Ω 1/2 W
R521	---- o ----	ERX12SJ3R3E	RES. METALIC FILM 3,30 Ω 1/2 W
R522	ERJ3GEYJ123V	ERJ3GEYJ123V	RES. METALIC FILM SMD 12 kΩ 1/10 W
R523	ERJ3GEYJ103V	ERJ3GEYJ103V	RES. METALIC FILM SMD 10 kΩ 1/10 W
R524	ERJ3GEYJ104V	ERJ3GEYJ104V	RES. METALIC FILM SMD 100 kΩ 1/10 W
R525	ERJ3GEYJ392V	ERJ3GEYJ392V	RES. METALIC FILM SMD 3,90 kΩ 1/10 W
R553	ERJ3GEYJ223V	ERJ3GEYJ223V	RES. METALIC FILM SMD 22 kΩ 1/10 W
R555	ERQ14AJ2R0E	ERQ14AJ2R0E	FUSISTOR 2 Ω 1/4 W
R557	ER050PKF1473	---- o ----	RES. METALIC FILM AXIAL 147 kΩ 1/2 W
R557	---- o ----	ER050PKF1743	RES. METALIC FILM AXIAL 174 kΩ 1/2 W
R558	ERDS2TJ223T	ERDS2TJ223T	RES. CARBONO 22 kΩ 1/4 W
R559	ERQ1CJP2R7S	---- o ----	FUSISTOR 2,70 Ω 1 W
R559	---- o ----	ERQ1CJP2R2S	FUSISTOR 2,20 Ω 1 W
R560	ERG1SJ102E	---- o ----	RES. METALIC FILM 1 kΩ 1 W
R601	ERJ3GEYJ153V	ERJ3GEYJ153V	RES. METALIC FILM SMD 15 kΩ 1/10 W
R602	ERJ3EKF3001V	ERJ3EKF3001V	RES. METALIC FILM SMD 3 kΩ 1/16 W
R603	ERJ3GEYJ393V	ERJ3GEYJ393V	RES. METALIC FILM SMD 39 kΩ 1/10 W
R604	ERJ3GEYJ101V	ERJ3GEYJ101V	RES. METALIC FILM SMD 100 Ω 1/10 W
R605	ERJ3GEYJ101V	ERJ3GEYJ101V	RES. METALIC FILM SMD 100 Ω 1/10 W
R606	ERJ3GEYJ101V	ERJ3GEYJ101V	RES. METALIC FILM SMD 100 Ω 1/10 W
R607	ERJ3GEYJ103V	ERJ3GEYJ103V	RES. METALIC FILM SMD 100 kΩ 1/10 W
R608	ERJ3GEYJ332V	ERJ3GEYJ332V	RES. METALIC FILM SMD 3,30 kΩ 1/10 W
R609	ERJ3GEYJ332V	ERJ3GEYJ332V	RES. METALIC FILM SMD 3,30 kΩ 1/10 W
R610	ERJ3GEYJ103V	ERJ3GEYJ103V	RES. METALIC FILM SMD 10 kΩ 1/10 W
R611	ERJ3GEYJ472V	ERJ3GEYJ472V	RES. METALIC FILM SMD 4,70 kΩ 1/10 W
R612	ERJ3GEYJ102V	ERJ3GEYJ102V	RES. METALIC FILM SMD 1 kΩ 1/10 W
R613	ERJ3GEYJ391V	ERJ3GEYJ391V	RES. METALIC FILM SMD 390 Ω 1/10 W
R614	ERJ3GEYJ392V	ERJ3GEYJ392V	RES. METALIC FILM SMD 3,90 kΩ 1/10 W
R615	ERJ3GEYJ102V	ERJ3GEYJ102V	RES. METALIC FILM SMD 1 kΩ 1/10 W
R616	ERJ3GEYJ392V	ERJ3GEYJ392V	RES. METALIC FILM SMD 3,90 kΩ 1/10 W
R617	ERJ6GEYJ181V	ERJ6GEYJ181V	RES. METALIC FILM SMD 180 Ω 1/8 W
R618	ERJ3GEYJ184V	ERJ3GEYJ184V	RES. METALIC FILM SMD 180 kΩ 1/10 W
R619	ERJ3GEYJ121V	ERJ3GEYJ121V	RES. METALIC FILM SMD 120 Ω 1/10 W
R620	ERJ3GEYJ121V	ERJ3GEYJ121V	RES. METALIC FILM SMD 120 Ω 1/10 W
R621	ERJ3GEYJ103V	ERJ3GEYJ103V	RES. METALIC FILM SMD 10 kΩ 1/10 W
R622	ERJ3GEYJ103V	ERJ3GEYJ103V	RES. METALIC FILM SMD 10 kΩ 1/10 W
R623	ERJ3GEYJ331V	ERJ3GEYJ331V	RES. METALIC FILM SMD 330 Ω 1/10 W
R624	ERJ3GEYJ103V	ERJ3GEYJ103V	RES. METALIC FILM SMD 10 kΩ 1/10 W
R625	ERJ3GEYJ222V	ERJ3GEYJ222V	RES. METALIC FILM SMD 2,20 kΩ 1/10 W
R626	ERJ3GEYJ104V	ERJ3GEYJ104V	RES. METALIC FILM SMD 100 kΩ 1/10 W
R627	ERJ3GEYJ683V	ERJ3GEYJ683V	RES. METALIC FILM SMD 68 kΩ 1/10 W
R628	ERJ3GEYJ563V	ERJ3GEYJ563V	RES. METALIC FILM SMD 56 kΩ 1/10 W
R629	ERJ3GEYJ154V	ERJ3GEYJ154V	RES. METALIC FILM SMD 150 kΩ 1/10 W
R630	ERJ3EKF1802V	ERJ3EKF1802V	RES. METALIC FILM SMD 18 kΩ 1/16 W
R631	ER050PKF5603	ER050PKF5603	RES. METALIC FILM 560 kΩ 1/2 W
R632	ERJ3GEYJ750V	ERJ3GEYJ750V	RES. METALIC FILM SMD 75 Ω 1/10 W
R633	ERJ3GEYJ470V	ERJ3GEYJ470V	RES. METALIC FILM SMD 47 Ω 1/10 W
R634	ERJ3GEYJ822V	ERJ3GEYJ822V	RES. METALIC FILM SMD 8,20 kΩ 1/10 W
R635	ERJ3GEYJ561V	ERJ3GEYJ561V	RES. METALIC FILM SMD 560 Ω 1/10 W
R636	ERJ3GEYJ562V	ERJ3GEYJ562V	RES. METALIC FILM SMD 5,60 kΩ 1/10 W
R643	ERJ3GEYJ272V	ERJ3GEYJ272V	RES. METALIC FILM SMD 2,70 kΩ 1/10 W
R655	ERJ3GEYJ103V	ERJ3GEYJ103V	RES. METALIC FILM SMD 10 kΩ 1/10 W
R660	ERJ3GEYJ274V	ERJ3GEYJ274V	RES. METALIC FILM SMD 270 kΩ 1/10 W
R661	ERJ3GEYJ103V	ERJ3GEYJ103V	RES. METALIC FILM SMD 10 kΩ 1/10 W
R662	ERJ3GEYJ333V	ERJ3GEYJ333V	RES. METALIC FILM SMD 33 kΩ 1/10 W
R801	ERF5ZK2R2	ERF5ZK2R2	RESISTOR DE FIO CIMENTADO 2,20 Ω 5 W
R806	ERJ3GEYJ222V	ERJ3GEYJ222V	RES. METALIC FILM SMD 2,20 kΩ 1/10 W
R807	ERJ6GEYJ152V	ERJ6GEYJ152V	RES. METALIC FILM SMD 1,50 kΩ 1/8 W
R809	ERX12SJR39E	ERX12SJR39E	RES. METALIC FILM 0,39 Ω 1/2 W
R811	ERJ3GEYJ681V	ERJ3GEYJ681V	RES. METALIC FILM SMD 680 Ω 1/10 W
R812	ERD75TAJ825	ERD75TAJ825	RES. CARBONO 8,20 MΩ 3/4 W
R814	ERJ3GEYJ332V	ERJ3GEYJ332V	RES. METALIC FILM SMD 3,30 kΩ 1/10 W
R817	ERG3FJ183H	ERG3FJ183H	RES. METALIC FILM 18 kΩ 3 W
R819	ERDS1TJ220T	ERDS1TJ220T	RES. CARBONO 22 Ω 1/2 W
R821	ERG2SJS333H	ERG2SJS333H	RES. METALIC FILM 33 kΩ 2W
R824	ERDS1TJ624T	ERDS1TJ624T	RES. CARBONO 620 kΩ 1/2 W
R825	ERJ3GEYJ473V	ERJ3GEYJ473V	RES. METALIC FILM SMD 47 kΩ 1/10 W

Ref. No.	TC-20B12	TC-20A12P	Description
R832	ERDS1TJ152T	ERDS1TJ152T	RES. CARBONO 1,50 k $\Omega$ 1/2 W
R835	ERX12SJR39E	ERX12SJR39E	RES. METALIC FILM 0,39 $\Omega$ 1/2 W
R850	ERQ12HKR68P	ERQ12HKR68P	FUSISTOR 0,68 $\Omega$ 1/2 W
R856	ERQ12HJ1R5P	ERQ12HJ1R5P	FUSISTOR 1,50 $\Omega$ 1/2 W
R857	ERQ12HKR82P	ERQ12HKR82P	FUSISTOR 0,82 $\Omega$ 1/2 W
R864	ERJ3GEYJ103V	ERJ3GEYJ103V	RES. METALIC FILM SMD 10 k $\Omega$ 1/10 W
R866	ERJ3GEYJ472V	ERJ3GEYJ472V	RES. METALIC FILM SMD 4,70 k $\Omega$ 1/10 W
R868	ERJ3GEYJ242V	ERJ3GEYJ242V	RES. METALIC FILM SMD 2,40 $\Omega$ 1/10 W
R870	EROS2THF220I	EROS2THF220I	RES. CARBONO 2,20 k $\Omega$ 1/4 W
R871	ERDS1TJ223T	ERDS1TJ223T	RES. CARBONO 22 k $\Omega$ 1/2 W
R1016	ERJ3EKF1651V	ERJ3EKF1651V	RES. METALIC FILM SMD 1,65 k $\Omega$ 1/16 W
R1017	ERJ3EKF2151V	ERJ3EKF2151V	RES. METALIC FILM SMD 2,15 k $\Omega$ 1/16 W
R1018	ERJ3EKF3091V	ERJ3EKF3091V	RES. METALIC FILM SMD 3,09 k $\Omega$ 1/16 W
R1019	ERJ3EKF4421V	ERJ3EKF4421V	RES. METALIC FILM SMD 4,42 k $\Omega$ 1/16 W
R1020	ERJ3EKF7501V	ERJ3EKF7501V	RES. METALIC FILM SMD 7,50 k $\Omega$ 1/16 W
R1021	ERJ3EKF1871V	ERJ3EKF1871V	RES. METALIC FILM SMD 1,87 k $\Omega$ 1/16 W
R1022	ERJ3GEYJ100V	ERJ3GEYJ100V	RES. METALIC FILM SMD 10 $\Omega$ 1/10 W
R1101	ERJ3GEYJ332V	ERJ3GEYJ332V	RES. METALIC FILM SMD 3,30 k $\Omega$ 1/10 W
R1104	ERJ3GEYJ562V	ERJ3GEYJ562V	RES. METALIC FILM SMD 5,60 k $\Omega$ 1/10 W
R1105	ERJ3GEYJ562V	ERJ3GEYJ562V	RES. METALIC FILM SMD 5,60 k $\Omega$ 1/10 W
R1106	ERJ3GEYJ102V	ERJ3GEYJ102V	RES. METALIC FILM SMD 1 k $\Omega$ 1/10 W
R1108	ERJ3GEYJ101V	ERJ3GEYJ101V	RES. METALIC FILM SMD 100 $\Omega$ 1/10 W
R1109	ERJ3GEYJ101V	ERJ3GEYJ101V	RES. METALIC FILM SMD 100 $\Omega$ 1/10 W
R1117	ERJ3GEYJ471V	ERJ3GEYJ471V	RES. METALIC FILM SMD 470 $\Omega$ 1/10 W
R1120	ERJ3GEYJ432V	ERJ3GEYJ432V	RES. METALIC FILM SMD 4,30 k $\Omega$ 1/10 W
R1122	ERJ3GEYJ332V	ERJ3GEYJ332V	RES. METALIC FILM SMD 3,30 k $\Omega$ 1/10 W
R1124	ERJ3GEYOR00V	ERJ3GEYOR00V	RES. METALIC FILM SMD 0 $\Omega$
R1125	ERDS2TJ560T	ERDS2TJ560T	RES. CARBONO 56 $\Omega$ 1/4 W
R1130	ERJ3GEYJ101V	ERJ3GEYJ101V	RES. METALIC FILM SMD 100 $\Omega$ 1/10 W
R1131	ERJ3GEYJ101V	ERJ3GEYJ101V	RES. METALIC FILM SMD 100 $\Omega$ 1/10 W
R1132	ERJ3GEYJ101V	ERJ3GEYJ101V	RES. METALIC FILM SMD 100 $\Omega$ 1/10 W
R1140	ERJ3EKF1002V	ERJ3EKF1002V	RES. METALIC FILM SMD 10 k $\Omega$ 1/16 W
R1141	ERJ3GEYJ562V	ERJ3GEYJ562V	RES. METALIC FILM SMD 5,60 k $\Omega$ 1/10 W
R2022	ERJ3GEYJ104V	ERJ3GEYJ104V	RES. METALIC FILM SMD 100 k $\Omega$ 1/10 W
R2301	ERJ3GEYJ562V	ERJ3GEYJ562V	RES. METALIC FILM SMD 5,60 k $\Omega$ 1/10 W
R2304	ERDS2TJ222T	ERDS2TJ222T	RES. CARBONO 2,20 k $\Omega$ 1/4 W
R2305	ERQ2CJP8R2S	ERQ2CJP8R2S	FUSISTOR 8,20 $\Omega$ 2 W
R2310	ERDS2TJ1R0T	ERDS2TJ1R0T	RES. CARBONO 1 $\Omega$ 1/4 W
R2318	ERJ3GEYJ332V	ERJ3GEYJ332V	RES. METALIC FILM SMD 3,30 k $\Omega$ 1/10 W
R2319	ERJ3GEYJ102V	ERJ3GEYJ102V	RES. METALIC FILM SMD 1 k $\Omega$ 1/10 W
R2320	ERJ3GEYJ102V	ERJ3GEYJ102V	RES. METALIC FILM SMD 1 k $\Omega$ 1/10 W
R2321	ERJ3GEYJ682V	ERJ3GEYJ682V	RES. METALIC FILM SMD 6,80 k $\Omega$ 1/10 W
R2322	ERJ3GEYJ153V	ERJ3GEYJ153V	RES. METALIC FILM SMD 15 k $\Omega$ 1/10 W
R2380	ERJ3GEYJ151V	ERJ3GEYJ151V	RES. METALIC FILM SMD 150 $\Omega$ 1/10 W
R2381	ERJ3GEYJ102V	ERJ3GEYJ102V	RES. METALIC FILM SMD 1 k $\Omega$ 1/10 W
R2382	ERJ3GEYJ102V	ERJ3GEYJ102V	RES. METALIC FILM SMD 1 k $\Omega$ 1/10 W
R2383	ERJ3GEYJ103V	ERJ3GEYJ103V	RES. METALIC FILM SMD 10 k $\Omega$ 1/10 W
R2419	ERDS2TJ680T	ERDS2TJ680T	RES. CARBONO 68 $\Omega$ 1/4 W
R3132	ERJ3GEYJ221V		RES. METALIC FILM SMD 220 $\Omega$ 1/10 W
R3133	ERJ3GEYJ221V		RES. METALIC FILM SMD 220 $\Omega$ 1/10 W
<b>SWITCHES</b>			
S1001	EVQ11G05R	EVQ11G05R	CHAVE DE TOQUE
S1002	EVQ11G05R	EVQ11G05R	CHAVE DE TOQUE
S1003	EVQ11G05R	EVQ11G05R	CHAVE DE TOQUE
S1004	EVQ11G05R	EVQ11G05R	CHAVE DE TOQUE
S1005	EVQ11G05R	EVQ11G05R	CHAVE DE TOQUE
S1006	EVQ11G05R	EVQ11G05R	CHAVE DE TOQUE
S801	ESB92DA1B	ESB92DA1B	CHAVE INTERRUPTORA
<b>TRANSFORMERS</b>			
T552	KFT3AA428F		FLY BACK
T552		KFT2AA427F	FLY BACK
T553	ETH19Y70AY	ETH19Y70AY	TRANSFORMADOR DRIVER
T801	TLP4GA020D	TLP4GA020D	TRANSFORMADOR CHOPER
<b>TUNER</b>			
TNR001	TEDH9-301A	TEDH9-301A	SELETOR DE CANAIS
<b>CRISTALS</b>			
X101	M1971M	M1971M	FILTRO SAW 45,75 MHZ
X180	EFCT4R5MW5	EFCT4R5MW5	FILTRO TRAP CER. 4,50 MHZ
X601	TSSA010	TSSA010	CRISTAL PIEZOELETRICO 12.000 MHZ

Ref. No.	TC-20B12	TC-20A12P	Description
<b>OTHERS</b>			
A22	BJP11V02-AP	BJP11V02-AP	PORTA TERMINAL MACHO
A5-L5	TXAJTA5CB14A12	TXAJTA5CB14A12	CONECTOR 3 VIAS
A8-L8	TXAJTA8CB20A12	TXAJTA8CB14A12	CONECTOR 6 VIAS
F801-L	TP00351-51	TP00351-51	SUPORTE DE FUSÍVEL
F801-R	TP00351-51	TP00351-51	SUPORTE DE FUSÍVEL
JK3001	TJB16664	TJB16664	AV TERMINAL
JK3101	TJB4G605	----- 0 -----	AV TERMINAL
JK351	330550044K2F	----- 0 -----	SOCKET (CRT 20")
JK351	----- 0 -----	330620065	SOCKET (CRT 14")





**Panasonic do Brasil Ltda.**

**CS GROUP - TECHNICAL SUPPORT**