

2SK61

シリコンNチャネル接合形電界効果トランジスタ SILICON N-CHANNEL JUNCTION FIELD EFFECT TRANSISTOR

- FMチューナ用
- VHF帯増幅用
- FM Tuner and VHF Amplifier Applications
- ・ 雑音指数が小さい; $NF = 2.5 \text{ dB (Typ.) (} f = 100 \text{ MHz)}$
- ・ 相互コンダクタンスが大きい; $g_m = 9 \text{ m}\Omega \text{ (Typ.)}$
- ・ 帰還容量が小さい; $C_{rss} = 0.1 \text{ pF (Typ.)}$
- ・ 使用電圧範囲 8 ~ 15V

最大定格 MAXIMUM RATINGS ($T_a = 25^\circ\text{C}$)

CHARACTERISTIC	SYMBOL	RATING	UNIT
ゲート・ドレイン間電圧	V_{GDO}	-18	V
ゲート電流	I_G	10	mA
許容損失	P_D	200	mW
接合温度	T_j	125	$^\circ\text{C}$
保存温度	T_{stg}	-55 ~ 125	$^\circ\text{C}$

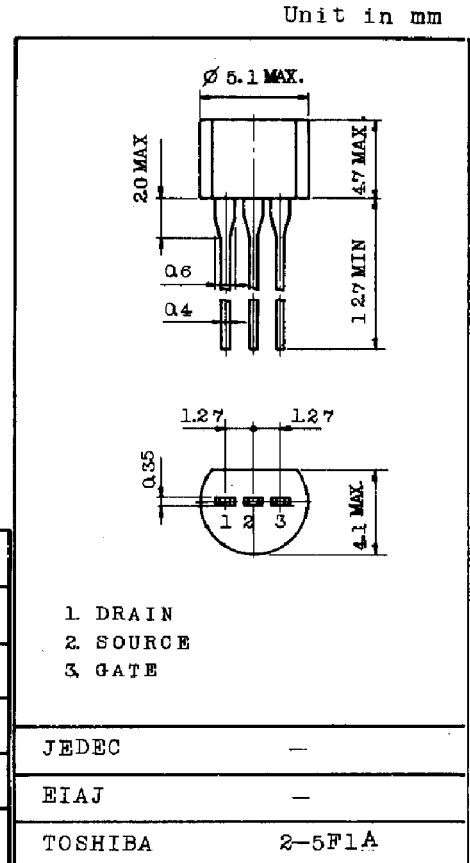

電気的特性 ELECTRICAL CHARACTERISTICS ($T_a = 25^\circ\text{C}$)

CHARACTERISTIC	SYMBOL	CONDITION	MIN.	TYP.	MAX.	UNIT
ゲート漏れ電流	I_{GSS}	$V_{GS} = -0.5 \text{ V}, V_{DS} = 0$	-	-	-10	nA
ゲート・ドレイン間降伏電圧	$V_{(BR)GDO}$	$I_G = -100 \mu\text{A}, \text{Common Drain}$	-18	-	-	V
ドレイン電流 (Note 1)	I_{DSS}	$V_{GS} = 0, V_{DS} = 10 \text{ V}$	1.0	-	10	mA
ピンチオフ電圧	V_P	$V_{DS} = 10 \text{ V}, I_D = 1 \mu\text{A}$	0.4	-	4.0	V
相互コンダクタンス (Note 2)	g_m	$V_{GS} = 0, V_{DS} = 10 \text{ V}$ $f = 1 \text{ kHz}$	-	9	-	$\text{m}\Omega$
帰還容量	C_{rss}	$V_{GD} = -10 \text{ V}, f = 1 \text{ MHz}$	-	0.10	0.15	pF
電力利得 (Fig. 1) (Note 2)	G_{PS}	$V_{DD} = 10 \text{ V}, f = 100 \text{ MHz}$	-	18	-	dB
雑音指数 (Fig. 1) (Note 2)	NF	$V_{DD} = 10 \text{ V}, f = 100 \text{ MHz}$	-	2.5	3.5	dB

2SK61

Note 1 ; I_{DSS} により下表のように分類し、現品表示してあります。

According to the value of I_{DSS} , 2SK61 is classified as follows.

CLASSIFICATION	MIN.	MAX.
2SK61-0	1.0	3.0
2SK61-Y	2.5	6.0
2SK61-GR	5.0	10.0

Fig.1 ; 100MHz G_{ps} , NF測定回路

100MHz G_{ps} and NF TEST CIRCUIT

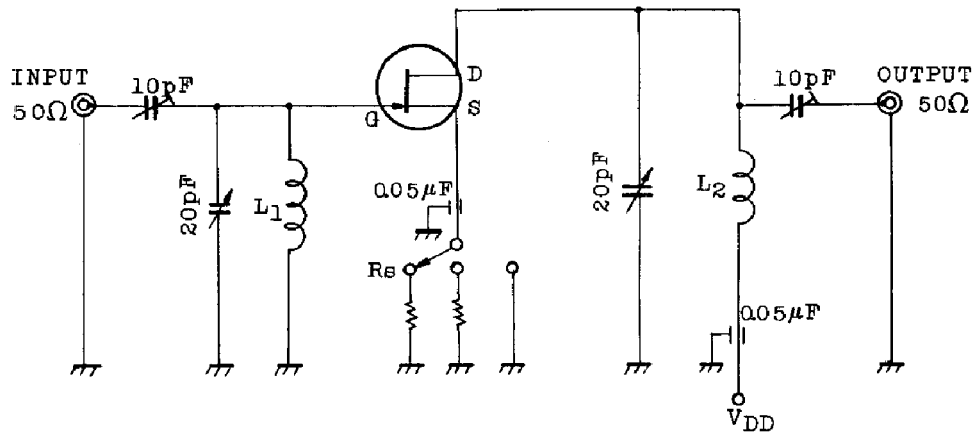

L₁ 0.8mmφ 銀メッキ線空心3T 捲径10mmφ 捲長10mm

0.8mmφ Ag PLATED Cu WIRE, 3 TURNS, 10mmφ DIA, 10mm LENGTH

L₂ 0.8mmφ 銀メッキ線空心3.5T 捲径10mmφ 捲長10mm

0.8mmφ Ag PLATED Cu WIRE, 3.5 TURNS, 10mmφ DIA, 10mm LENGTH

Note 2 ; グループごとにソース抵抗 R_s を切換えて測定する。

2SK61 is measured at each group by changing R_s .

GROUP	R_s (Ω)
2SK61-0	0
2SK61-Y	$18 \pm 5\%$
2SK61-GR	$100 \pm 5\%$

2SK61

STATIC CHARACTERISTICS

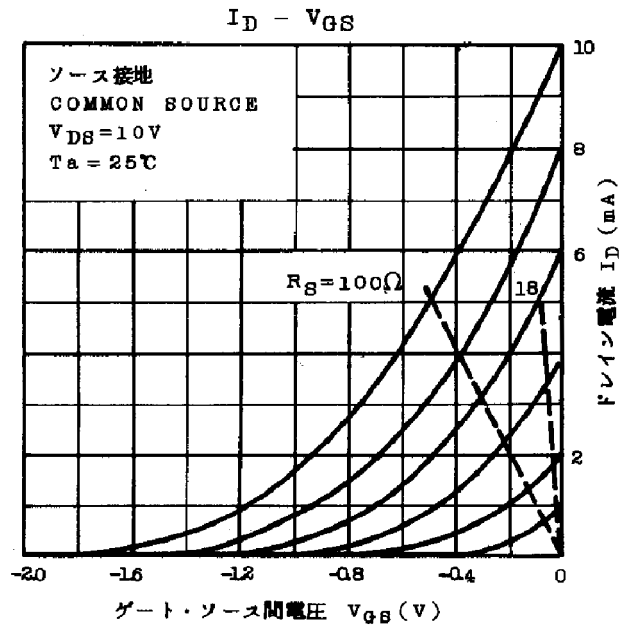
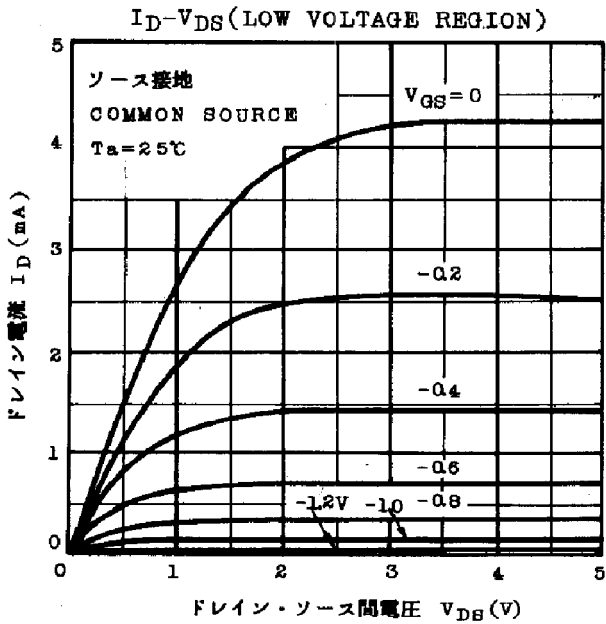
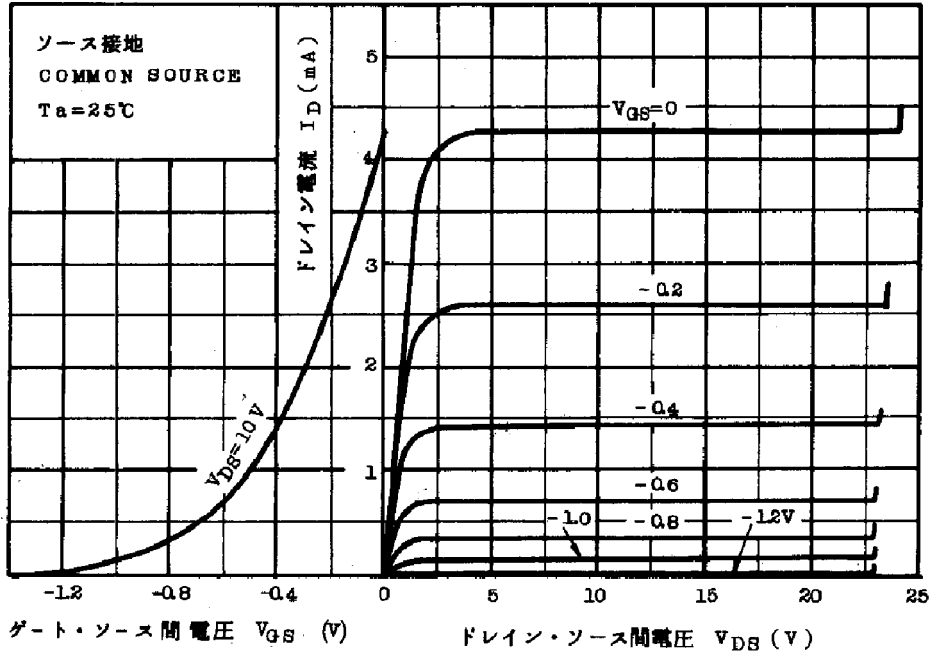

2SK61

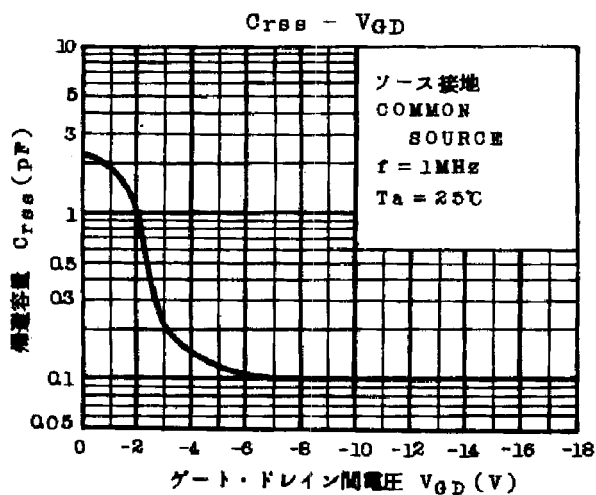
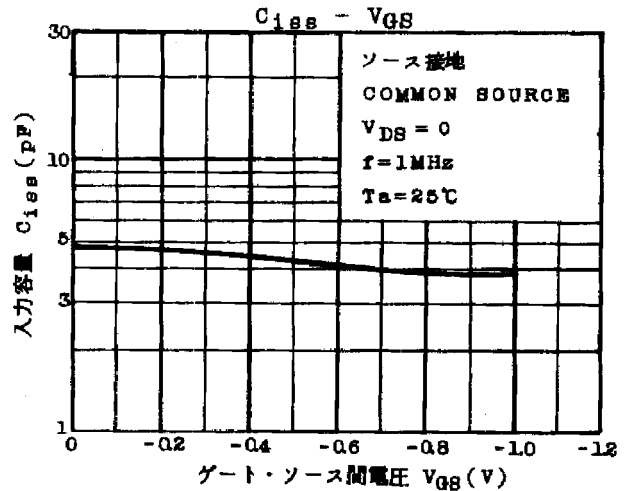
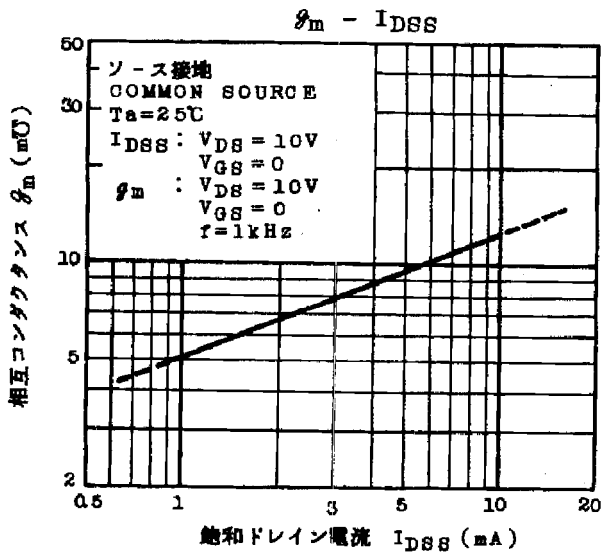
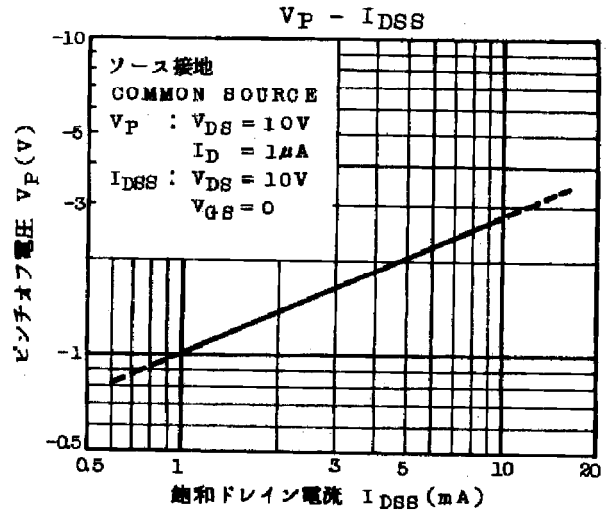
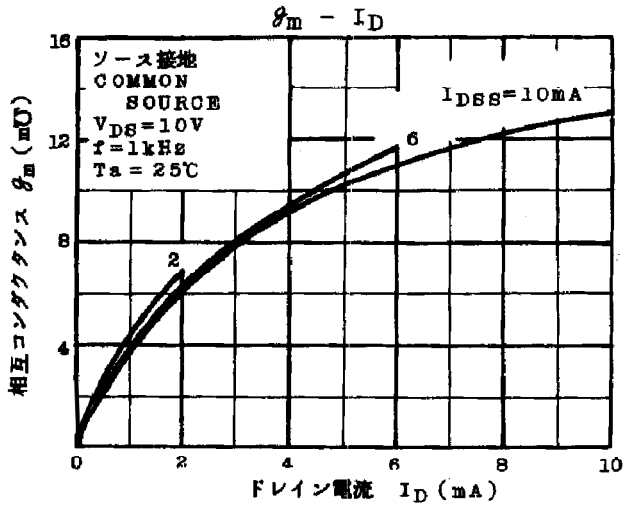

2SK61

