

## 5V/1.5A Backup Battery Pack Manager

### FEATURES

- Dedicated Single Chip Solution for Mobile Power With Minimal Component Count
- 5V/1.5A Constant Output Current in Boost Mode
- 1.5A Switching Charger
- Programmable 4.1V to 4.35V Battery Voltage
- 95% Boost Efficiency (Vbat=4.1V)
- Adaptive to 10mA-2400mA Input Sources
- Battery Disconnection at Output Short
- <10µA Low Battery Leakage Current at HZ Mode During Storage
- Boost Auto Turn-off at No Load and Push Button Turn-on
- Battery Over Current, Over Voltage, Over Temperature and Short Circuit Protections
- Boost Auto Startup with Load Detection
- Up to 2.0A Input Current Limit with Prioritized Power Path to Output
- 5V+/-100mV Output Voltage in Boost Mode
- 1.1MHz/0.55MHz Boost Switching Frequencies
- 2.2µH SMD Inductor and Low Profile Ceramic Capacitors
- 4 LEDs Battery Level and Status Indication
- Battery Impedance Compensation
- Full Cycle of Battery Charge Management Preconditioning, Fast Charge, Top Off and End of Charge
- Charge Current Foldback at 110°C Die Temperature
- IC Over Temperature Protection at 160°C
- QFN4x4-24 Package

### APPLICATIONS

- Backup Battery Pack
- Power Bank
- Mobile Power
- Standalone Battery Charger with USB Output

### GENERAL DESCRIPTION

ACT2801 is a space-saving and high-performance low-profile single-chip solution for backup battery pack and standalone battery charger. ACT2801 integrates all the functions that a backup battery pack needs, including switching charger, boost converter and LED indication.

ACT2801 operates at 2.2MHz/1.1MHz for switching charger and 1.1MHz/0.55MHz for boost converter allowing tiny external inductor and capacitors. ACT2801 provides a direct power path from input to output with programmable current limit while providing power to switching charger. Output has higher priority than battery charger if the programmed input current limit is reached.

ACT2801 charges battery with full cycle of preconditioning, fast charge with constant current and constant voltage until end of charge. The battery charger is thermally regulated at 110°C with charge current foldback.

ACT2801 boost converter steps battery voltage up to 5V. Boost converter features high efficiency, constant current regulation, short circuit protection and over voltage protection.

ACT2801 provides 3.5mA constant currents to drive 4 LEDs to indicate battery level and charge status.

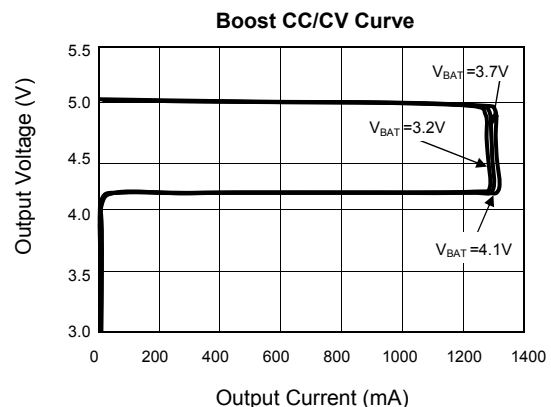
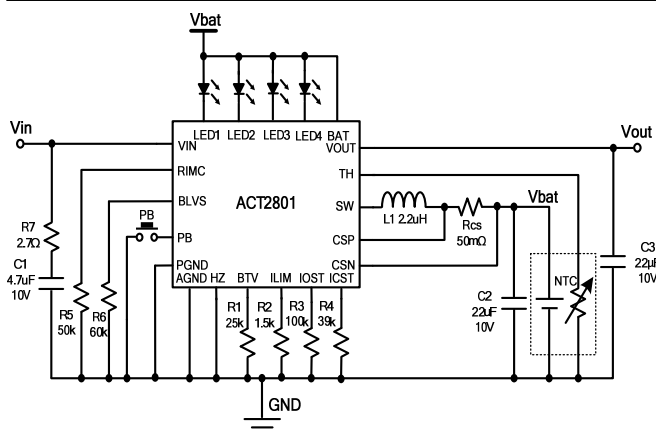

## ORDERING INFORMATION

PART NUMBER	BOOST SWITCH FREQUENCY	OUTPUT	CHARGE CURRENT	PACKAGE	PACKING
ACT2801QL-T	1.1MHz	5V/1.5A	1.5A	QFN44-24	TAPE & REEL, 3KU/REEL
ACT2801QL-T0550	0.55MHz	5V/1.5A	1.5A	QFN44-24	TAPE & REEL, 3KU/REEL

## PIN CONFIGURATION

### TOP VIEW

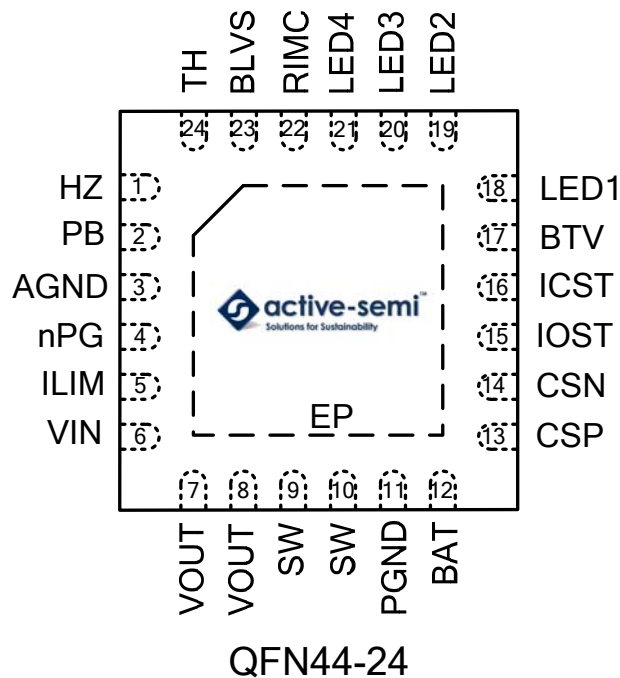

## PIN DESCRIPTIONS

PIN	NAME	DESCRIPTION
1	HZ	Boost high-Z mode enable pin, internally pulled up by a 3MΩ resistor to battery. When HZ pin is pulled ground, boost is enabled if VIN is not present.
2	PB	Push button input, connect a push button from this pin to AGND, internally pulled up by a 3MΩ resistor to battery. When this pin is pushed for 100ms, LED1-4 indicators are enable for 5 seconds. PB starts up boost converter if HZ pin is grounded and VIN is not present.
3	AGND	Logic ground.
4	nPG	Drive external P-FET to protect output short circuit and leakage during shutdown. nPG pin is pulled up to VOUT internally. nPG pin is pulled low if VOUT is in the range.
5	ILIM	Input current limit setting pin. Connect a resistor from this pin to AGND to set the input current limit. The current setting ranges from 0.5A-2.0A.
6	VIN	USB or AC adaptor input. When VIN is valid, charge and power path is enabled.
7, 8	VOUT	Output pin. Bypass to PGND with a high quality low ESR and ESL ceramic capacitor placed as close to the IC as possible.
9, 10	SW	Internal switch to output inductor terminal.
11	PGND	Power ground. PGND is connected to the source of low-side N-channel MOSFET and the MOSFET's gate driver.
12	BAT	Battery input. Connected to the battery pack positive terminal to provide power in High -Z mode. Bypass to PGND with a high quality ceramic capacitor placed as close to the IC as possible.
13	CSP	Positive terminal of charge current sense input. Kevin sense is required with 10nF ceramic capacitor right across CSP and CSN pins.
14	CSN	Negative terminal of charge current sense input.
15	IOST	Output current setting. Connect a resistor from this pin to AGND to set output constant current. The current setting ranges from 0.5A-1.5A.
16	ICST	Fast charge current setting pin. Connect a resistor from this pin to AGND to set the charge current. The current setting ranges from 0.5A-1.5A.
17	BTV	Battery termination voltage setting. Connect a resistor from this pin to AGND to program battery charge termination voltage.
18	LED1	Battery level indicator. An internal 3.5mA sink current limit is built in.
19	LED2	Battery level indicator. An internal 3.5mA sink current limit is built in.
20	LED3	Battery level indicator. An internal 3.5mA sink current limit is built in.
21	LED4	Battery level indicator. An internal 3.5mA sink current limit is built in.
22	RIMC	Battery impedance compensation input. Connect to a resistor from this pin to APNG to program the battery impedance.
23	BLVS	Battery level voltage shift. Connect a resistor from this pin to AGND to shift the battery LED indication thresholds.
24	TH	Temperature sensing input. Connect to battery thermistor terminal. If no use, put 10K pulled down resistor.
25	EP	Exposed pad. Must be soldered to ground on the PCB.

**ABSOLUTE MAXIMUM RATINGS<sup>①</sup>**

PARAMETER	VALUE	UNIT
All the pin to PGND and AGND	-0.3 to 6.5	V
Junction to Ambient Thermal Resistance	40	°C/W
Maximum Power Dissipation	2.5	W
Operating Ambient Temperature Range	-40 to 85	°C
Operating Junction Temperature	-40 to 150	°C
Storage Junction Temperature	-40 to 150	°C
Lead Temperature (Soldering 10 sec.)	300	°C

①: Do not exceed these limits to prevent damage to the device. Exposure to absolute maximum rating conditions for long periods may affect device reliability.

## ELECTRICAL CHARACTERISTICS

( $V_{IN} = 5V$ ,  $T_A = 25^\circ C$ , unless otherwise specified.)

PARAMETER	TEST CONDITIONS	MIN	TYP	MAX	UNIT
<b>Input Current Limit</b>					
Input Voltage Range		4.5		5.5	V
$V_{IN}$ Over Voltage Protection	$V_{IN}$ rising, $V_{IN\_OVP}$	5.5	6.0	6.5	V
Input Voltage Validation Time	$V_{IN\_UVLO} < V_{IN} < V_{IN\_OVP}$		32		ms
Input Current Limit Setting Range	$R_{ILIM} = 1.2k\Omega - 4.8k\Omega$	0.5		2.0	A
Input Current Limit	$R_{ILIM} = 2k\Omega$	-10%	1.2	+10%	A
Input Current Limit Gain			2000		
Leakage Current from VOUT to VIN in Boost Mode	$3.0V < V_{BAT} < 4.35V$ , $T_a = 25^\circ C$		0	10	$\mu A$
Battery Discharge Current in High-Z Mode	$3.0V < V_{BAT} < 4.35V$ , $T_a = 25^\circ C$		7.5	15	$\mu A$
<b>Power Switches</b>					
VIN-to-VOUT FET on Resistance			90		m $\Omega$
VOUT-to-SW FET on Resistance			70		m $\Omega$
SW-to-PGND FET on Resistance			75		m $\Omega$
<b>Buck Converter</b>					
Switching Frequency	ACT2801QL-T	-15%	2.2	+15%	MHz
	ACT2801QL-T0550	-15%	1.1	+15%	MHz
High Side Switch Peak Current Limit		3.5	5		A
Minimum On-time			100		ns
Over Temperature Protection (OTP)	OTP rising		160		$^\circ C$
OTP Hysteresis	OTP falling		35		$^\circ C$
<b>Charge Mode</b>					
Charge Current Setting Range	$R_{CS} = 50m\Omega$ , $R_{ICST} = 20k\Omega - 60.4k\Omega$	0.5		1.5	A
Charge Current Setting	$R_{CS} = 50m\Omega$ , $R_{ICST} = 39k\Omega$	-10%	975	+10%	mA
Thermal Regulation Temperature			110		$^\circ C$
Battery Adjust Voltage ( $V_{BAJ}$ )	$R_{btv} = 25k\Omega$		0.1		V
End of Charge (EOC) Voltage		-0.5%	$4.1 + V_{BAJ}$	0.5%	V
EOC Voltage Accuracy	$R_{btv} = 0$		4.1		V
Battery Over Voltage Threshold	VBAT rising		4.6		V
Battery Over Voltage Threshold Hysteresis	VBAT falling		200		mV

## ELECTRICAL CHARACTERISTICS

 (V<sub>IN</sub> = 5V, T<sub>A</sub> = 25°C, unless otherwise specified.)

PARAMETER	TEST CONDITIONS	MIN	TYP	MAX	UNIT
Fast Charge Current	V <sub>BAT</sub> =3.5V	-10%	I <sub>CHRG</sub>	10%	A
Precondition Charge Current	2.4V ≤ V <sub>BAT</sub> ≤ 2.8V, Percent of I <sub>CHRG</sub>		10		%
Precondition Voltage Threshold	V <sub>BAT</sub> rising, R <sub>btv</sub> =0		2.8		V
Precondition Voltage Threshold Hysteresis			130		mV
Low V <sub>BAT</sub> Charge Current	V <sub>BAT</sub> =1V, R <sub>ICST</sub> =39kΩ		200		mA
EOC Current Threshold	V <sub>BAT</sub> =4.2V, ratio to the fast charge current	4	13	25	%
Charge Restart Voltage Threshold			200		mV
TH Upper Temperature Voltage Threshold	Cold detect NTC thermistor	1.45	1.5	1.55	V
TH Lower Temperature Voltage Threshold	Hot detect NTC thermistor	0.28	0.3	0.32	V
TH Hysteresis			50		mV
TH Internal Pull-up Current			60		μA
<b>Boost Mode</b>					
Input Voltage Operation Range		3.0		4.5	V
Switching Frequency	ACT2801QL-T	-15%	1.1	+15%	MHz
	ACT2801QL-T0550	-15%	0.55	+15%	MHz
Input Voltage UVLO	V <sub>BAT</sub> rising		3.3		V
Input Voltage UVLO Hysteresis	V <sub>BAT</sub> falling		2.9		V
Output Voltage	T <sub>a</sub> =25°C	4.97	5.05	5.10	V
Output Voltage Accuracy	All conditions	-3	V <sub>OUT</sub>	2	%
Output Voltage Transient Response	80mA-1A-80mA, 0.1A/us	4.8		5.25	V
Output Over Voltage Protection	V <sub>OUT</sub> rising	5.5	5.7	5.9	V
Output Over Voltage Protection Hysteresis	V <sub>OUT</sub> falling		300		mV
Output Current Regulation Range	R <sub>CS</sub> =50mΩ, R <sub>IOST</sub> =37.5kΩ—113kΩ	0.5		1.5	A
Output Current Limit	R <sub>CS</sub> =50mΩ, R <sub>IOST</sub> =75kΩ	-10%	1.0	+10%	A
Minimum On-Time			100		ns
Low Side Switch Peak Current Limit	V <sub>BAT</sub> =3.2V, V <sub>OUT</sub> =5V	3	5.0		A
Soft-Startup Time			400		μs
Under Voltage Protection (UVP Threshold)	V <sub>OUT</sub> falling	4.1	4.25	4.4	V

## ELECTRICAL CHARACTERISTICS

( $V_{IN} = 5V$ ,  $T_A = 25^\circ C$ , unless otherwise specified.)

PARAMETER	TEST CONDITIONS	MIN	TYP	MAX	UNIT
Under Voltage Protection (UVP Threshold)	VOUT rising		4.6		V
UVP Blanking Time During Startup			3		ms
UVP Sense Detection Time	VOUT falling		20		μs
Restart After UVP	Hiccup mode		2		s
Light Load Current Shut off Threshold		2	40	80	mA
Light Load Current Detect Time			90		s
HZ Pin High Voltage	HZ voltage rising		0.9	1.4	V
HZ Pin Low Voltage	HZ voltage falling	0.4	0.75		V
HZ Internal Pull-up Resistor			3		MΩ
PB Turn off Boost Time			3		s
PB Turn on Boost Time			100		ms
<b>Mode Transition</b>					
Transition Waiting Time between Charge Mode and Boost Mode	TRANTIME		2		s
<b>Battery Level Indication</b>					
Battery Impedance Compensation Range		40		500	mΩ
Battery Impedance Compensation	$R_{cs}=50m\Omega$ , $R_{IMC}=100k\Omega$		200		mΩ
PB Deglitch Time			100		ms
PB High Input Voltage	PB voltage rising		0.9	1.4	V
PB Low Input Voltage	PB voltage falling	0.4	0.75		V
PB Internal Pull-up Resistor			3		MΩ
LED Indication Time	PB is pushed and released		5		s
LED Flash Frequency	Charging, LED flash 1s on and 1s off		0.5		Hz

## FUNCTIONAL BLOCK DIAGRAM

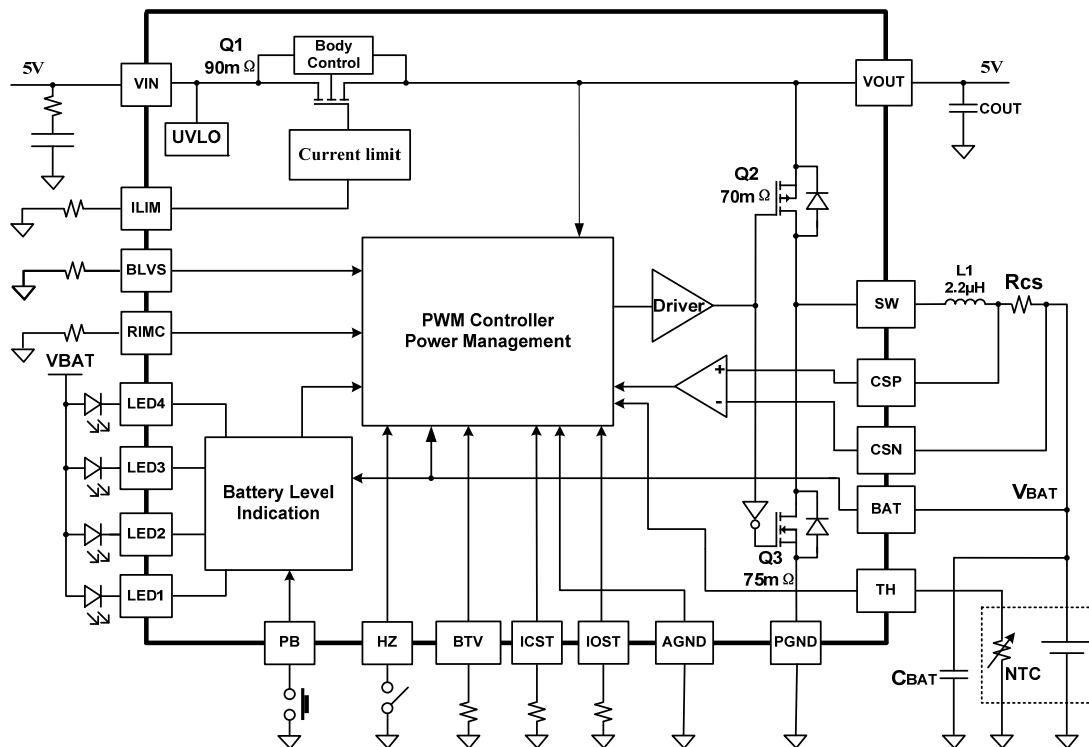

## FUNCTIONAL DESCRIPTION

ACT2801 is a complete battery charging and discharging power management solution for applications of single-cell lithium-based backup battery pack or power bank. There is a power path from input to output with programmable input current limit. When output is over loaded, the input switch Q1 starts going into linear mode and thus output voltage starts to drop. If output voltage drops below 4.25V, the input switch Q1 turns off and restart in 2 seconds.

With the advanced ACT2801 architecture, a synchronous buck/boost converter is connected from VOUT to switching node (SW). With the bidirectional architecture, the converter could be configured as either buck to charge battery or boost to discharge battery. With switching charger and discharger, the higher charge current and higher conversion efficiency are achieved.

### Modes of Operation

ACT2801 has 3 operation modes: charge mode, boost mode and high-impedance (HZ) mode. In charge mode, the input current limit is enabled and the Q2 and Q3 operate as a buck converter to charge battery. In boost mode, Q2 and Q3 operate as boost converter to step battery voltage up to +5V

at VOUT, and the current limit switch Q1 is turned off, and the reverse current from VOUT to VIN is blocked. In HZ mode, all the switches are turned off and the drainage current from battery is very low. The system operation flow chart as shown in Figure 1.

Any transitions between boost mode and charge mode go through HZ mode by turning off all the switches Q1-Q3 into HZ mode for 2 seconds before enabling the other mode.

The modes are determined by HZ pin and VIN pin as shown in the table 1. A valid VIN voltage forces ACT2801 into charge mode. Boost mode is enabled if HZ pin is pulled low and VIN is invalid or not present. When HZ=0, if PB is pulled low for more than 100ms, boost converter is enabled. A running boost is disabled if one of the following conditions is met:

1. After PB is released, if PB is pulled low for more than 3 seconds.
2. Boost converter output current is below light load threshold for 1.5 minutes.
3. Battery voltage falls below the boost cut-off threshold.



## FUNCTIONAL DESCRIPTION

Figure 1.  
ACT2801 System Operation Flow Chart

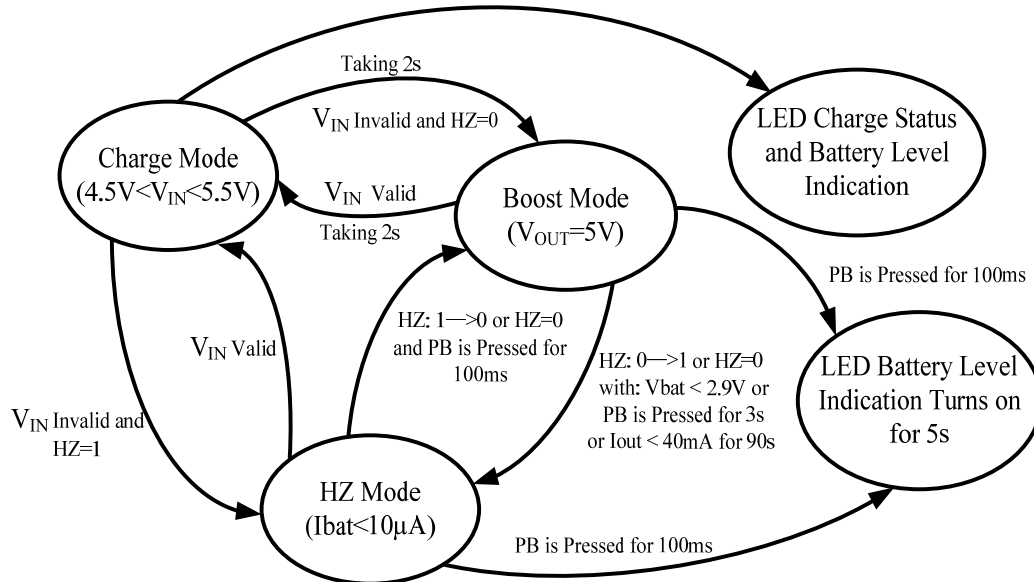

Table 1: Mode Selection

HZ PIN	0	0	1	1
VIN Valid	0	1	0	1
Mode	Boost	Charge	HZ	Charge

### Input Current Limit

When the input current reaches the programmed value, switch Q1 goes into linear mode and output voltage starts to drop. When output voltage drops to 4.25V, hiccup mode is triggered and switch Q1 turns off and restart in 2 seconds.

### Switching Battery Charger

ACT2801 is configured in charge mode (buck mode) when VIN is valid. In this mode, a battery is charged with preconditioning, fast charge, top-off and end of charge (EOC). The typical charge management is shown in Figure 2 and Figure 3.

### CC/CV Regulation Loop

There are CC/CV regulation loops built in ACT2801, which regulates either current or voltage as necessary to ensure fast and safe charging of the battery. In a normal charge cycle, this loop regulates the current to the value set by the external resistor at the ICST pin. Charging continues at this current until the battery cell voltage reaches the termination voltage. At this point the CV loop takes over, and charge current is allowed

to decrease as necessary to maintain charging at the termination voltage.

### Precondition Charge

A new charging cycle begins with the precondition state, and operation continues in this state until V<sub>BAT</sub> exceeds the precondition threshold voltage. When operating in precondition state, the cell is charged at a reduced current, 10% of the programmed maximum fast charge constant current. Once V<sub>BAT</sub> reaches the precondition threshold voltage the state machine jumps to the fast charge state.

### Fast Charge

If battery voltage is above preconditioning threshold, buck converter charges battery with constant current. In fast charge state, the ACT2801 charges at the current set by the external resistor connected at the ICST pin. During a normal charge cycle fast charge continues in CC mode until V<sub>BAT</sub> reaches the charge termination voltage, at which point the ACT2801 charges in top off state.

### Top Off

With the battery voltage approaches the EOC voltage set by the BTV pin. Charge current decreases as charging continues. In the top off state, the cell is charged in constant voltage (CV) mode. During a normal charging cycle charging proceeds until the charge current decreases below

## FUNCTIONAL DESCRIPTION

the end of charge (EOC) threshold, defined as 13% of fast charge current. When this happens, the state machine terminates the charge cycle and jumps to the EOC state.

### End of Charge

When charges current decreases to 13% of set fast charge current, the buck converter goes into end of

charge mode and keep monitoring the battery voltage.

### Recharge

When battery voltage drops by 200mV below the end of charge voltage, the charger is reinitiated with constant current charge.

**Figure 2.**  
Typical Li+ Charge Profile and ACT2801 Charge States

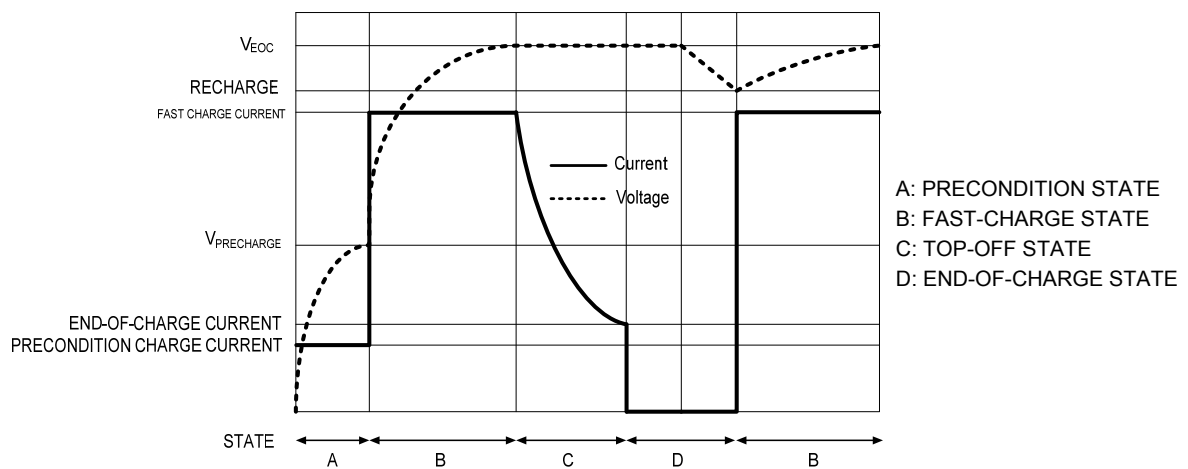

**Figure 3.**  
Charger State Diagram

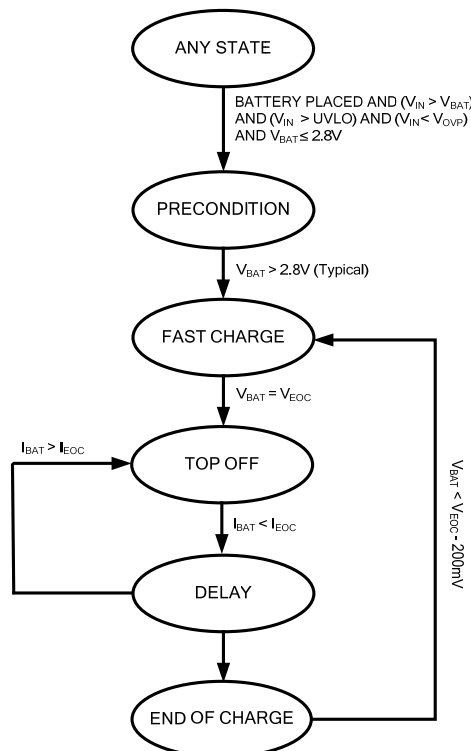

## APPLICATIONS INFORMATION

### Battery Charge Termination Voltage

Battery charge termination voltage is set by a resistor R<sub>btv</sub> connected from BTV pin to AGND as shown in Figure 4. The battery charge termination voltage is estimated as the following equation:

$$V_{BAT} (V) = 4.1(V) + R_{btv} \times 4 \times 10^{-6} (V) \quad (1)$$

R<sub>btv</sub> is selected based on the battery voltage rating. 1% accuracy resistor is recommended for R<sub>btv</sub>.

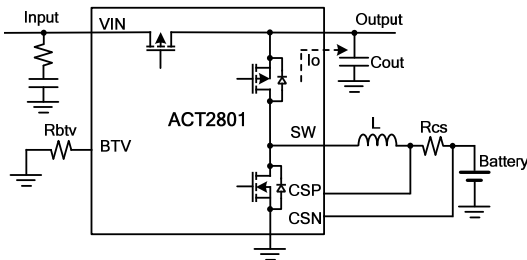

Figure 4. Battery terminal voltage setting circuit

### LED Status Indication

4 LEDs ON/OFF and flash show the charge status and the remained capacity level as shown in the table 2. The LED status is based on battery voltage and operation modes. In charge mode, when a battery is fully charged, flashing stops and all the 4 LEDs are solid on.

### Battery level voltage shift (BLVS pin)

LED1-4 voltage thresholds are adjusted from HZ mode during charging and discharging based on the compensated impedance. Those thresholds are

programmed by a resistor connected from BLVS pin to AGND as shown in Figure 5. The following equation shows the LED4 voltage threshold:

$$V_{BATLED4} (V) = 3.5(V) + 0.01(mA) \times R_{BLVS} (k\Omega) \quad (2)$$

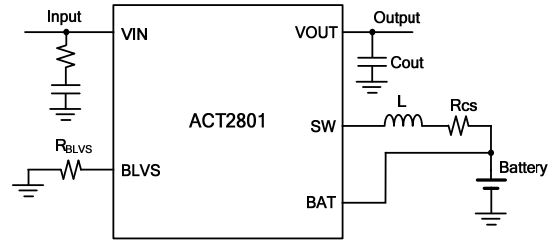

Figure 5. Battery level voltage shift setting circuit

As long as LED4 is set, all the other 3 LED thresholds is fixed as shown in the table 3:

Table 3: 4 LED Voltage Thresholds

R <sub>BLVS</sub> (ohm)	50K	60K	70K	80K
LED1	3.35V	3.45V	3.55V	3.65V
LED2	3.60V	3.70V	3.80V	3.90V
LED3	3.75V	3.85V	3.95V	4.05V
LED4	4.00V	4.10V	4.20V	4.30V

### Input Current Limit

An external resistor is used to set the input current limit connected from ILIM pin to AGND as shown in Figure 6. Input current limit has built-in soft startup and current foldback control loop. The input current limit is estimated as the following equation:

$$I_{ILIM} (A) = \frac{2.4 (V)}{R_{ILIM} (k\Omega)} \quad (3)$$

Table2: LED Indication

	Charge Mode				PB time>100ms (Boost or HZ Mode)			
	LED1	LED2	LED3	LED4	LED1	LED2	LED3	LED4
V <sub>BAT</sub> <LED1	Flash	Off	Off	Off	Off	Off	Off	Off
LED1≤V <sub>BAT</sub> <LED2	On	Flash	Off	Off	On	Off	Off	Off
LED2≤V <sub>BAT</sub> <LED3	On	On	Flash	Off	On	On	Off	Off
LED3≤V <sub>BAT</sub> <LED4	On	On	On	Flash	On	On	On	Off
V <sub>BAT</sub> ≥LED4	On	On	On	Flash	On	On	On	On
V <sub>BAT</sub> ≥LED4 (End of Charge)	On	On	On	On	On	On	On	On

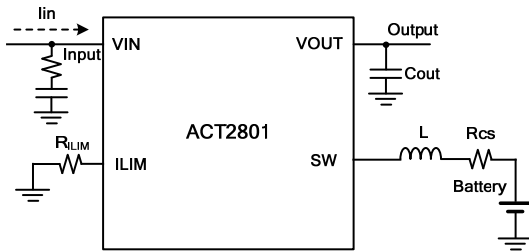

Figure 6. Input current limit setting circuit

Input current limit at various resistor curve is shown in Figure 7.

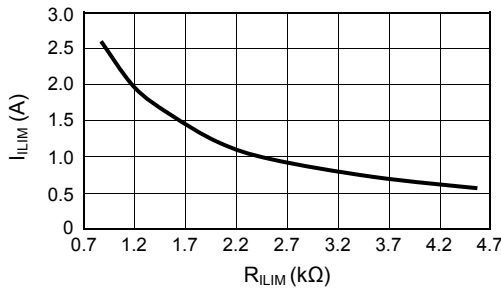

Figure 7. Input current limit setting

### Battery Fast Charge Current

Battery fast charge current is set by a resistor connected from ICST pin to AGND as shown in Figure 8, figure 9 gives out different fast charge current with various R\_ICST. The battery fast charge current is estimated as the following equation:

$$I_c(A) = 1.25(A) \times \frac{R_{ICST}(k\Omega)}{R_{CS}(m\Omega)} \quad (4)$$

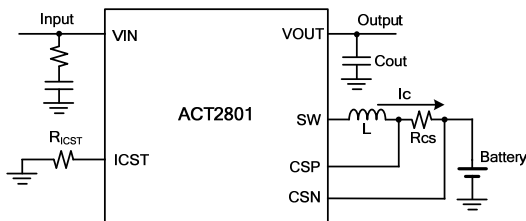

Figure 8. Battery fast charge current setting circuit

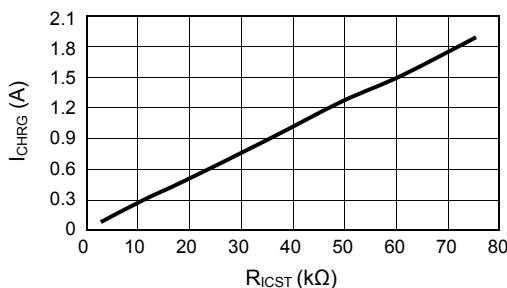

Figure 9. Battery fast charge current setting

### Boost Output Constant Current

Boost output current is set by a resistor connected

from IOST pin to AGND as shown in Figure 10. The boost output current is estimated as the following equation:

$$I_{IOST}(A) = \frac{2}{3}(A) \times \frac{R_{IOST}(k\Omega)}{R_{CS}(m\Omega)} \quad (5)$$

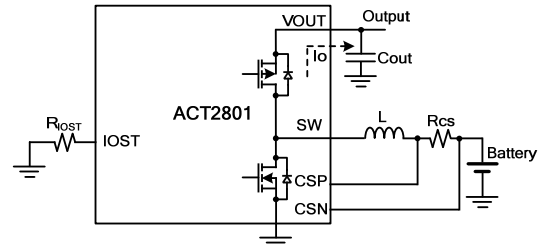

Figure 10. Boost output current setting circuit

Figure 11 gives out boost output current with various R\_IOST.

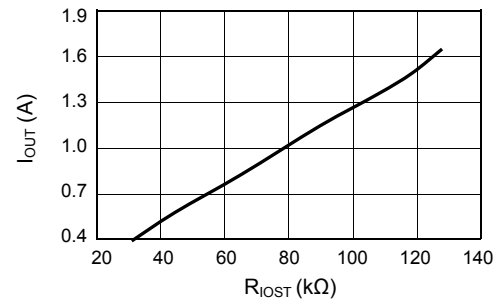

Figure 11. Boost output current setting

### Battery Impedance Compensation

An external resistor is used to set the impedance from 40mΩ to 500mΩ as shown in Figure 12. R\_IMC is corresponding to battery impedance. Higher R\_IMC gives higher compensation voltage which is positively proportional to battery charge/discharge current.

Select R\_IMC based on battery impedance:

$$R_{IMC}(k\Omega) = \frac{25 \times R(m\Omega)}{R_{CS}(m\Omega)} \quad (6)$$

$$V_{BAT}(V) = BAT(V) - I_{BAT}(A) \times R(m\Omega) \times 10^{-3} \quad (7)$$

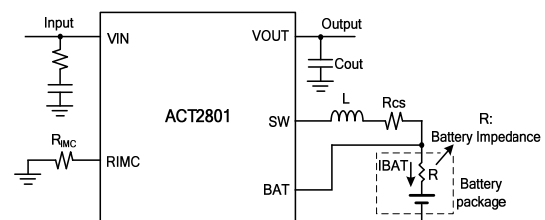

Figure 12. Battery impedance compensation

The battery impedance as shown in the table 4 according to the R\_IMC and R\_CS:

Table 4: Battery Impedance

R <sub>IMC</sub> (KΩ)		50	100	200
Battery Impedance R(mΩ)	R <sub>cs</sub> =25mΩ	50	100	200
	R <sub>cs</sub> =50mΩ	100	200	400

### Boost Output Plug-in Auto Detection

Figure 13 provides a solution for auto plug-in detection.

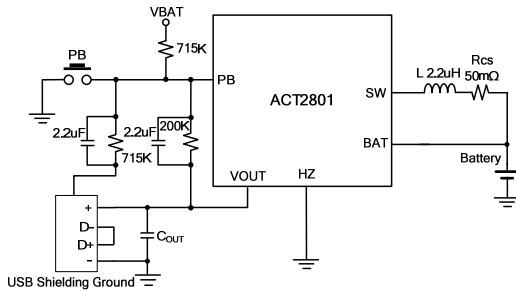

Figure 13. Boost output auto detection circuit

### Input Over Voltage Surge

In the case of pure ceramic input capacitor is chosen, if the input cable is long, stray inductance may cause over voltage spikes as twice as the steady-state voltage when input source is plugged in. Below input circuit is recommended to avoid input voltage surge. R10 resistor is added in series with capacitor C3 to damp the potential LC resonance as shown in Figure 14.

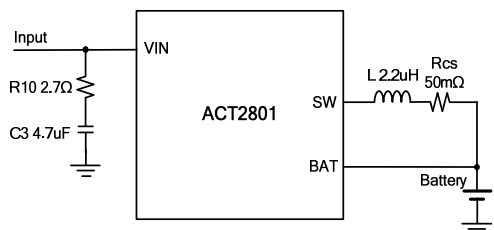

Figure 14. Input over voltage surge protection circuit

### External Input Over Voltage Protection

Considering the maximum voltage rating at VIN pin, the external OVP circuit as shown in Figure 15 is recommended if input voltage may go higher than 7V. With the enhanced OVP circuit, input voltage can be up to 18V.

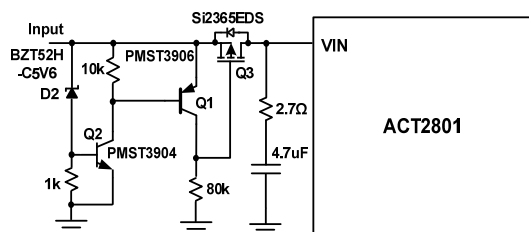

Figure 15. Input over voltage protection circuit

### Flashlight Circuit

Figure 16 shows a circuit with flashlight driver and control.

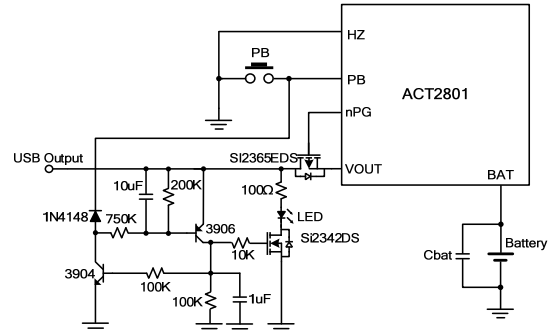

Figure 16. Flashlight circuit

### LEDs on in Boost Mode

LEDs can be always on during boost mode, the schematic is shown in Figure17.

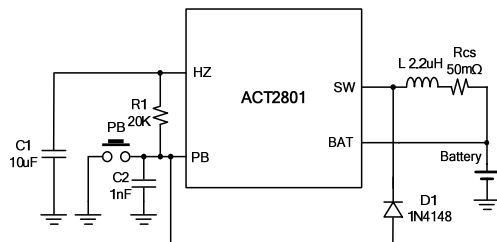

Figure 17. LEDs on in boost mode

### Inductor and Capacitor Selection

ACT2801 supports SMD components. 2.2uH SMD inductor is recommended. On input side, 4.7uF ceramic capacitor in series with 2.7Ω resistor are recommended, while on battery side and output sides, 22uF ceramic capacitors are recommended.

### Battery Temperature Monitoring

The ACT2801 continuously monitors the temperature of the battery pack by sensing the resistance of its thermistor, and suspends charging if the temperature of the battery pack exceeds the safety limits.

In a typical application, the TH pin is connected to the battery pack's thermistor input as shown in Figure 18. The ACT2801 injects a 60μA current out of the TH pin into the thermistor, so that the thermistor resistance is monitored by comparing the voltage at TH to the internal V<sub>THL</sub> and V<sub>THH</sub> thresholds of 0.3V and 1.5V, respectively. When V<sub>TH</sub> > V<sub>THH</sub> or V<sub>TH</sub> < V<sub>THL</sub> charging and the charge timers are suspended. When V<sub>TH</sub> returns to the normal range, charging and the charge timers resume.

The net resistance from TH to GND required to cross the threshold is given by:

$$60\mu\text{A} \times R_{\text{NOM}} \times k_{\text{HOT}} = 0.3\text{V} \rightarrow R_{\text{NOM}} \times k_{\text{HOT}} = 5\text{k}\Omega$$

$$60\mu\text{A} \times R_{\text{NOM}} \times k_{\text{COLD}} = 1.5\text{V} \rightarrow R_{\text{NOM}} \times k_{\text{COLD}} = 25\text{k}\Omega$$

where  $R_{\text{NOM}}$  is the nominal thermistor resistance at room temperature, and  $k_{\text{HOT}}$  and  $k_{\text{COLD}}$  are the ratios of the thermistor's resistance at the desired hot and cold thresholds, respectively.

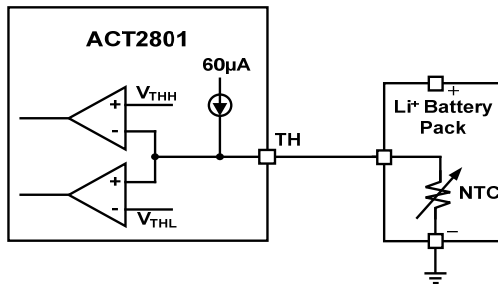

Figure 18. Battery thermal circuit

## PC Board Layout Guidance

When laying out the printed circuit board, the following checklist should be used to ensure proper operation of the IC.

1. Arrange the power components to reduce the AC loop size, VIN pin, Vout pin, SW pin and the Schottky diode.
2. Place ceramic capacitor C3 and resistor R10 as close to VIN pin as possible. R10 is added in series with capacitor C3 to damp the potential LC resonance .
3. Use copper plane for power GND for best heat dissipation and noise immunity.
4. Place CSP and CSN capacitor C6 (10nF) close to CSP and CSN pin as possible, use Kevin Sense from sense resistor R2 to CSP and CSN pins. 22uF decoupling capacitor is added close to BAT pin.
5. Place the ceramic capacitor C2 and D1 as

close to VOUT and PGND as possible, SW goes under the C2 (recommend C2 to use 1206 size). SW pad is a noisy node switching. It should be isolated away from the rest of circuit for good EMI and low noise operation.

6. Thermal pad is connected to GND layer through vias (recommend 4X4 pins and the aperture is 10mil). Ground plane, PGND and AGND is single point connected under the ACT2801 thermal pad through vias to limited SW area.
7. From BAT pin to the Battery positive terminal, need to lay the divided line to ensure the battery voltage accuracy of sampling.
8. RC snubber is recommended to add across SW to PGND to reduce EMI noise. 1A/20V Schottky is added to across V<sub>OUT</sub> and SW pins.

A demo board PCB layout example is shown in the figure 19.

**Figure 19.**  
**PCB Layout**

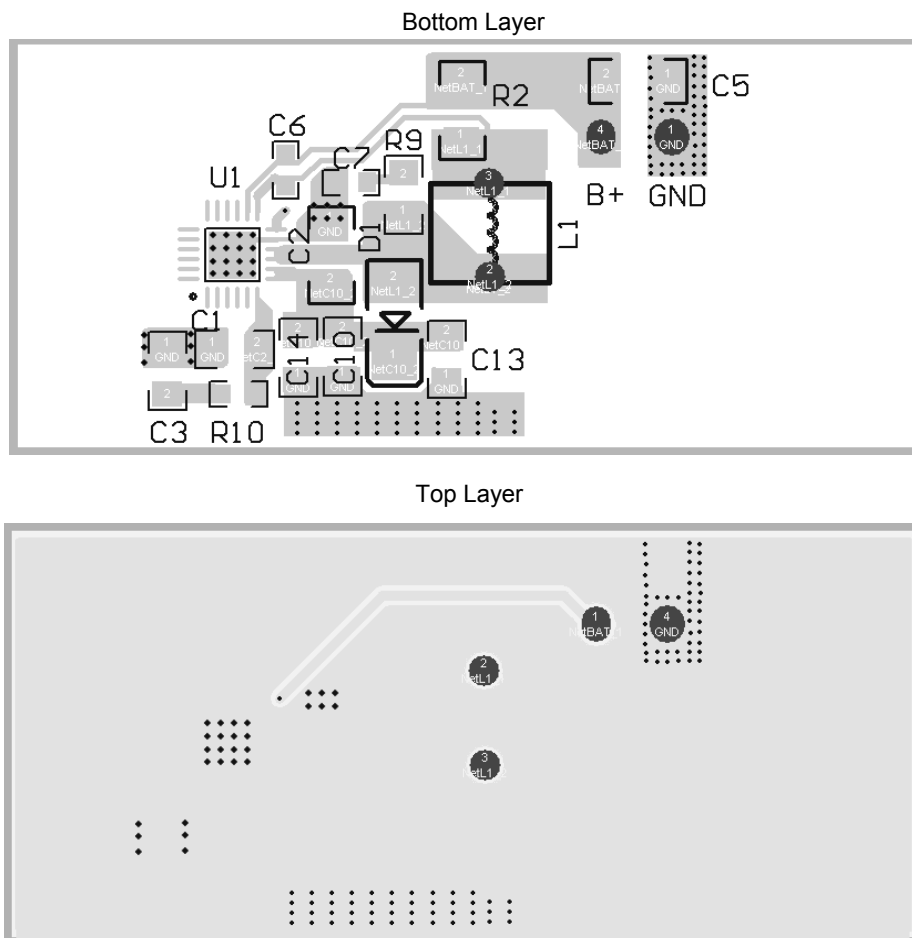

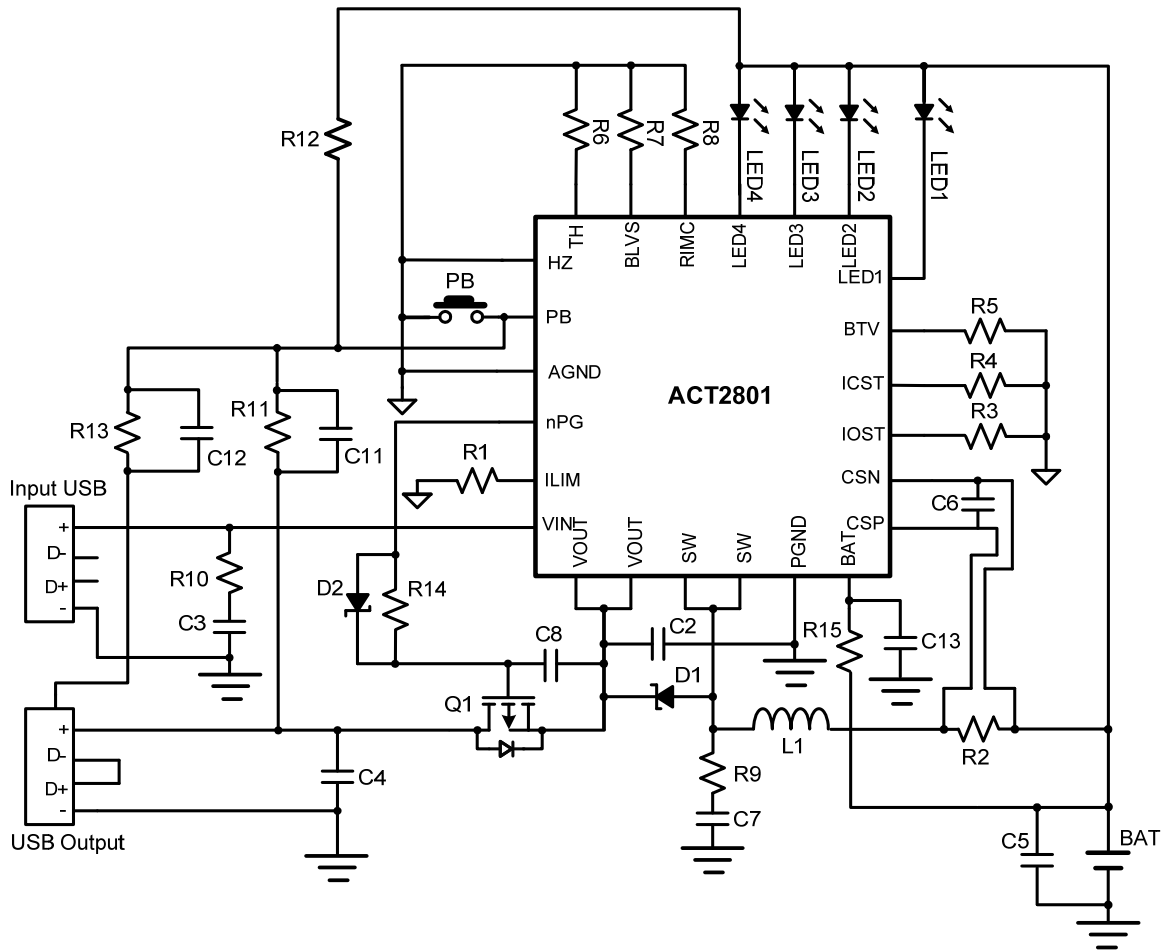

Figure 20. Typical application circuit  
(Input current limit 2.0A, fast charge current limit 1.5A, boost output constant current limit 1.3A)



## BOM List

ITEM	REFERENCE	DESCRIPTION	QTY	MANUFACTURER
1	L1	SWPA4020S1R0NT 2.2uH 3.4A (4*4*2mm)	1	Sunlord
2	Q1	SI2333DDS, Rdson=28mΩ at VGS = - 4.5 V	1	Vishay
3	D1	SS12, Vf=0.5V, 20V Schottky	1	Panjit
4	D2	1N4148, Vf=0.7V, 75V Schottky	1	Vishay
5	C2,C5	Ceramic Capacitor, 22uF/10V, X7R, 1206	2	Murata/TKD
6	C3	Ceramic Capacitor, 4.7uF/10V, X7R, 1206	1	Murata/TKD
7	C4	Ceramic Capacitor, 0.1uF/10V, X7R, 0603	1	Murata/TKD
8	C6	Ceramic Capacitor, 10nF/10V, X7R, 0402	1	Murata/TKD
9	C7	Ceramic Capacitor, 1nF/10V, X7R, 0603	1	Murata/TKD
10	C8	Ceramic Capacitor, 1uF/10V, X7R, 0603	1	Murata/TKD
11	C11,C12,C13	Ceramic Capacitor, 2.2uF/10V, X7R, 0603	3	Murata/TKD
12	R1	Chip Resistor, 1.2kΩ, 1/16W, 1%, 0402	1	Murata/TKD
13	R2	Chip Resistor, 50mΩ, 1/4W, 1%, 1206	1	Murata/TKD
14	R3	Chip Resistor, 100kΩ, 1/16W, 1%, 0402	1	Murata/TKD
15	R4	Chip Resistor, 60.4kΩ, 1/16W, 1%, 0402	1	Murata/TKD
16	R5	Chip Resistor, 25kΩ, 1/16W, 1%, 0402	1	Murata/TKD
17	R6	Chip Resistor, 10kΩ, 1/16W, 1%, 0402	1	Murata/TKD
18	R7	Chip Resistor, 60kΩ, 1/16W, 1%, 0402	1	Murata/TKD
19	R8	Chip Resistor, 50kΩ, 1/16W, 1%, 0402	1	Murata/TKD
20	R9	Chip Resistor, 1Ω, 1/8W, 5%, 0805	1	Murata/TKD
21	R10	Chip Resistor, 2.7Ω, 1/4W, 5%, 1206	1	Murata/TKD
22	R11	Chip Resistor, 200kΩ, 1/10W, 5%, 0603	1	Murata/TKD
23	R12,R13	Chip Resistor, 715kΩ, 1/10W, 5%, 0603	2	Murata/TKD
24	R14	Chip Resistor, 100kΩ, 1/10W, 5%, 0603	1	Murata/TKD
25	R15	Chip Resistor, 2.2Ω, 1/10W, 5%, 0603	1	Murata/TKD
26	LED1,LED2, LED3,LED4	LED, 0603, Blue	4	LED Manu
27	PB	Push Button Switch	1	Nikkai Omron
28	USB	10.2*14.6*7mm, 4P	1	
29	Micro-USB	MICRO USB 5P/F SMT B	1	
30	U1	IC, ACT2801, T-QFN 44-24	1	ACT

**TYPICAL PERFORMANCE CHARACTERISTICS CONT'D**

(Schematic as show in Figure 20, Ta = 25°C, unless otherwise specified)

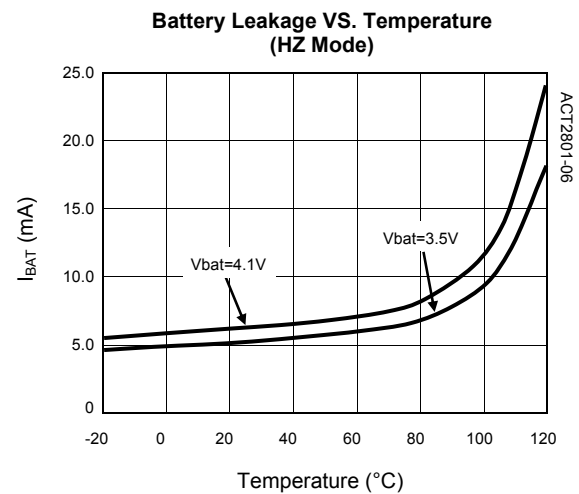
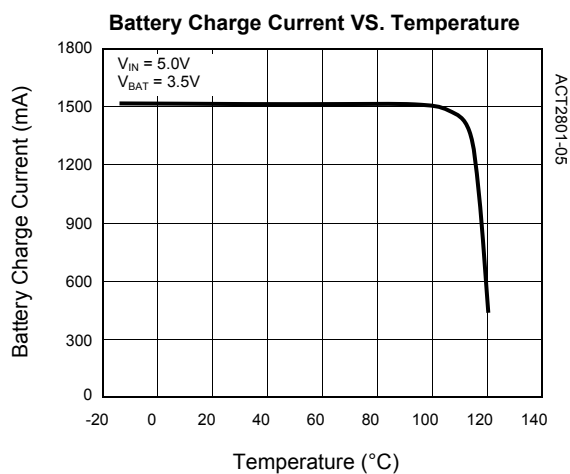
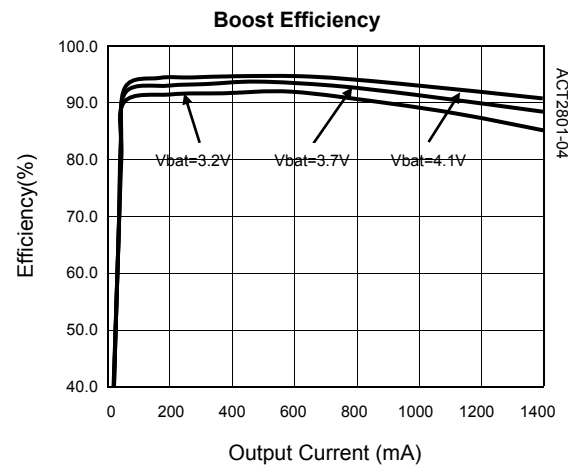
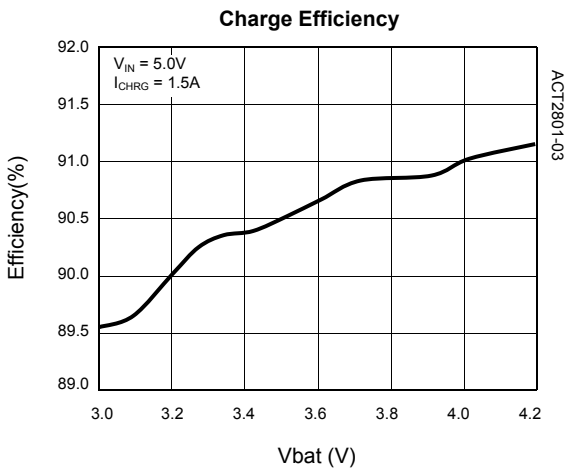
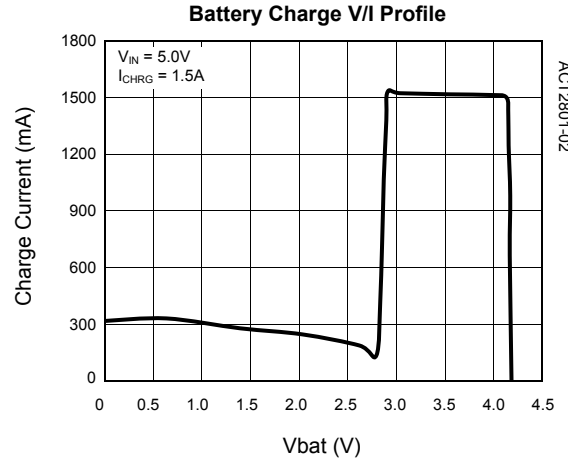
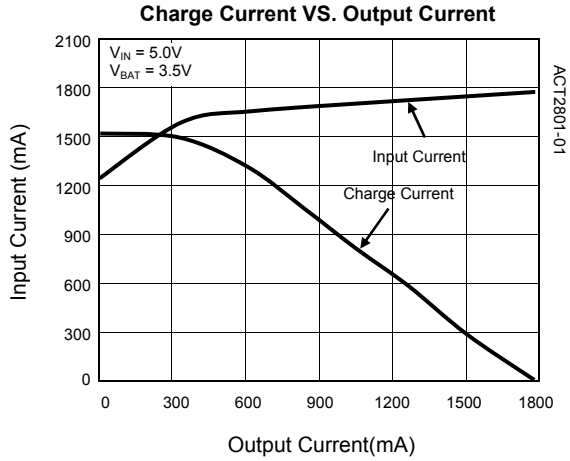

## TYPICAL PERFORMANCE CHARACTERISTICS CONT'D

(Schematic as show in Figure 20, Ta = 25°C, unless otherwise specified)

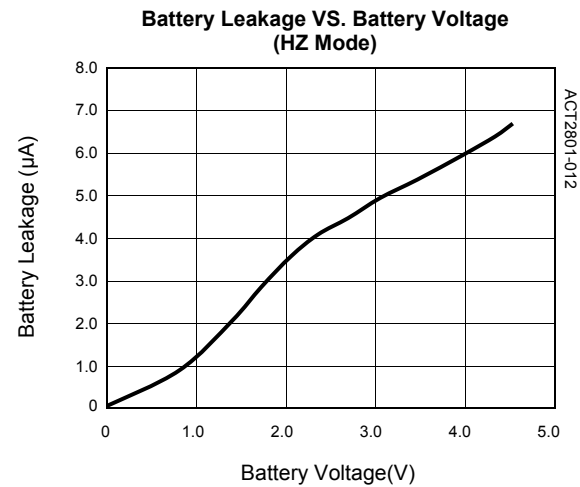
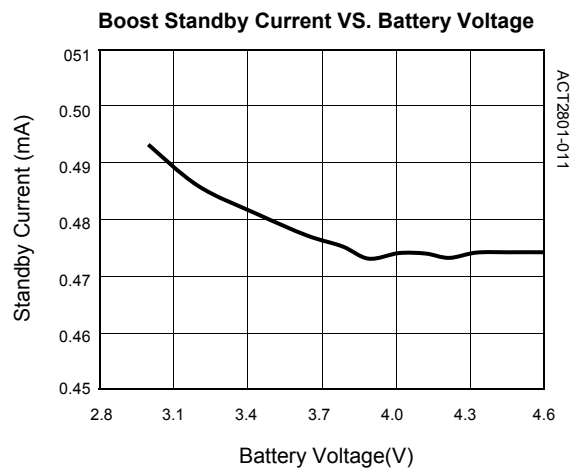
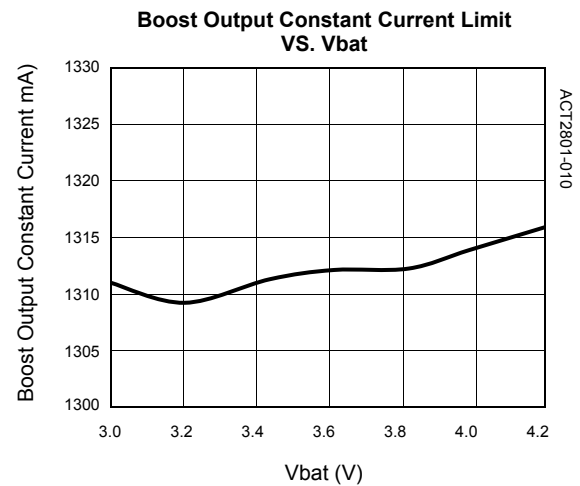
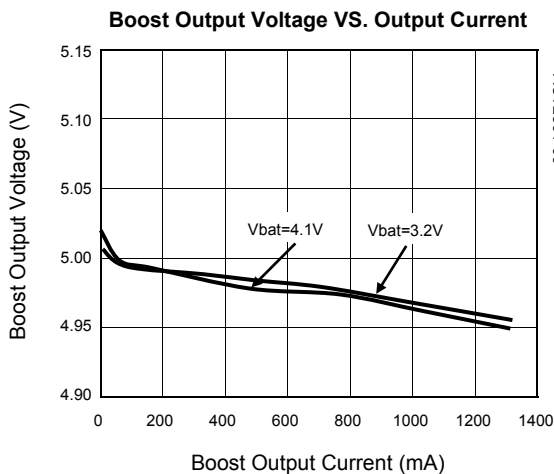
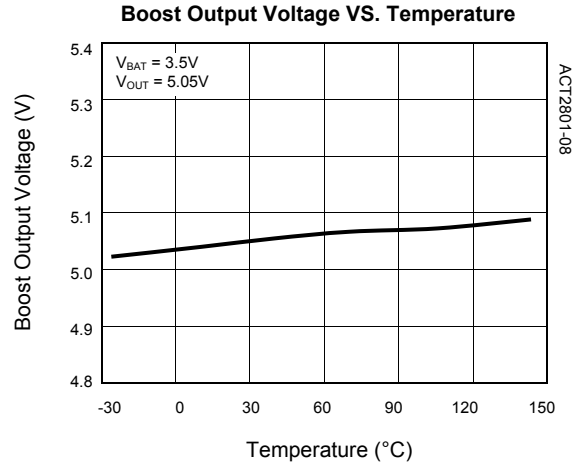
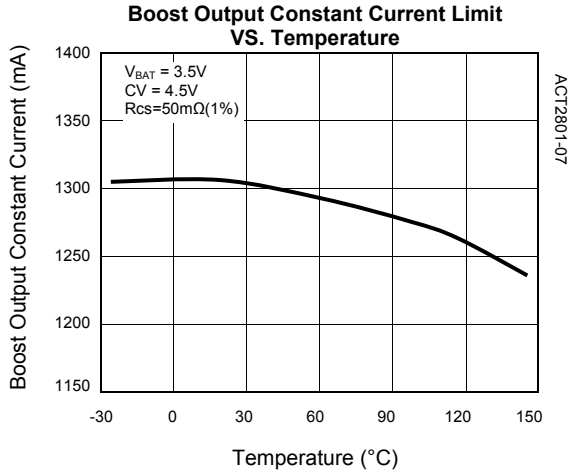

## TYPICAL PERFORMANCE CHARACTERISTICS CONT'D

(Schematic as show in Figure 20, Ta = 25°C, unless otherwise specified)

**Boost Load Transient (80mA-1A-80mA)**

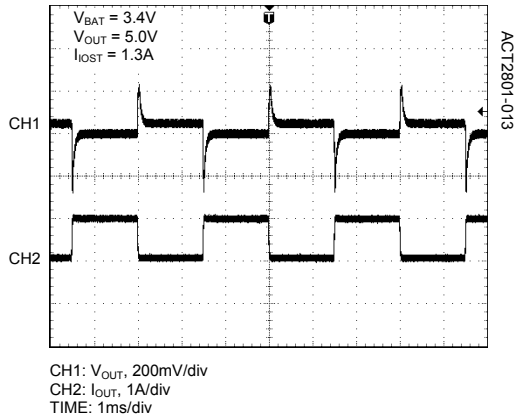

**Boost Load Transient (80mA-1A-80mA)**

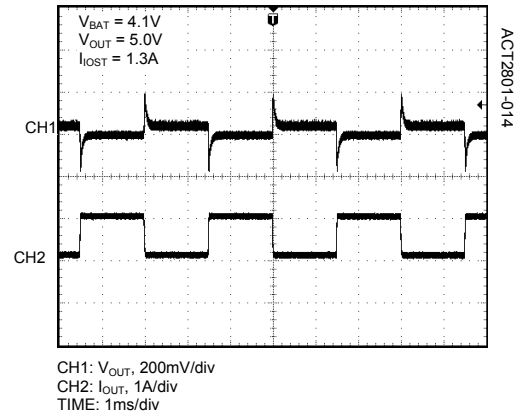

**SW and Output Waveforms in Boost Mode**

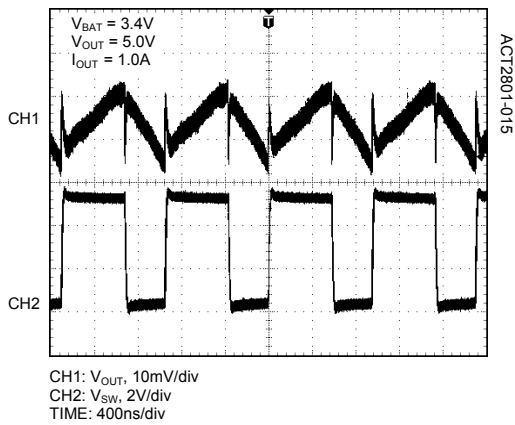

**SW and Output Waveforms in Boost Mode**

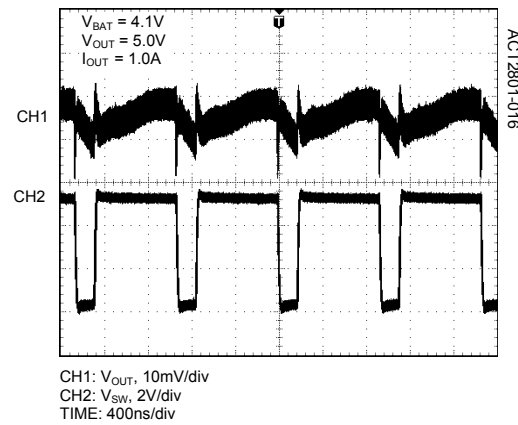

**Transition Between Buck Mode  
and Boost Mode**

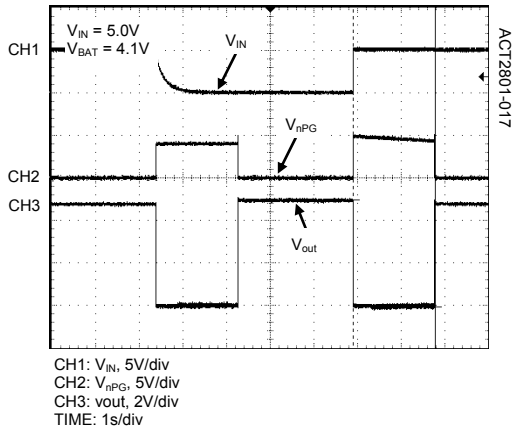

## PACKAGE OUTLINE

### QFN44-24 PACKAGE OUTLINE AND DIMENSIONS

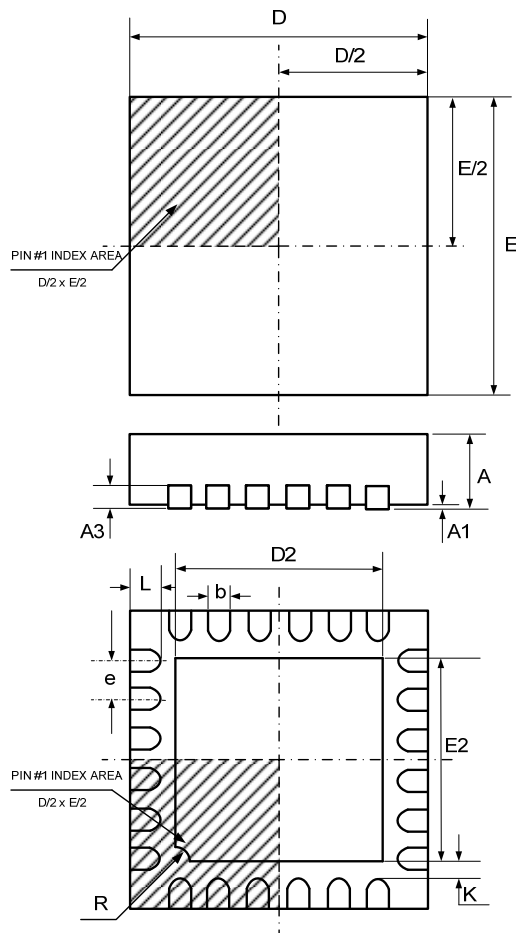

SYMBOL	DIMENSION IN MILLIMETERS		DIMENSION IN INCHES	
	MIN	MAX	MIN	MAX
A	0.700	0.800	0.028	0.031
A1	0.000	0.050	0.000	0.002
A3	0.200 REF		0.008 REF	
b	0.180	0.300	0.007	0.012
D	3.850	4.150	0.152	0.163
E	3.850	4.150	0.152	0.163
D2	2.500	2.800	0.098	0.110
E2	2.500	2.800	0.098	0.110
e	0.500 BSC		0.020 BSC	
L	0.350	0.450	0.014	0.018
R	0.200 TYP		0.008 TYP	
K	0.200	---	0.008	---

Active-Semi, Inc. reserves the right to modify the circuitry or specifications without notice. Users should evaluate each product to make sure that it is suitable for their applications. Active-Semi products are not intended or authorized for use as critical components in life-support devices or systems. Active-Semi, Inc. does not assume any liability arising out of the use of any product or circuit described in this datasheet, nor does it convey any patent license.

Active-Semi and its logo are trademarks of Active-Semi, Inc. For more information on this and other products, contact [sales@active-semi.com](mailto:sales@active-semi.com) or visit <http://www.active-semi.com>.

 is a registered trademark of Active-Semi.