

AGR19045EF 45 W, 1930 MHz—1990 MHz, PCS LDMOS RF Power Transistor

Introduction

The AGR19045EF is a 45 W, 28 V N-channel laterally diffused metal oxide semiconductor (LDMOS) RF power field effect transistor (FET) suitable for personal communication service (PCS) (1930 MHz—1990 MHz), global system for mobile communication (GSM/EDGE), time-division multiple access (TDMA), and single-carrier or multicarrier class AB power amplifier applications.

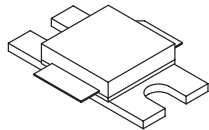

Figure 1. AGR19045EF (flanged) Package

- Typical two carrier N-CDMA performance: $V_{DD} = 28$ V, $I_{DQ} = 550$ mA, $f_1 = 1958.75$ MHz, $f_2 = 1961.25$ MHz, IS-95 CDMA (pilot, sync, paging, traffic codes 8—13). Peak/average (P/A) = 9.72 dB at 0.01% probability on CCDF. 1.2288 MHz transmission bandwidth (BW). Adjacent channel power ratio (ACPR) measured over 30 kHz BW at $f_1 - 885$ kHz and $f_2 + 885$ kHz. Third-order intermodulation distortion (IM3) measured over a 1.2288 MHz BW at $f_1 - 2.5$ MHz and $f_2 + 2.5$ MHz:
 - Output power (P_{OUT}): 9.5 W.
 - Power gain: 15 dB.
 - Efficiency: 24.8%.
 - IM3: -34.5 dBc.
 - ACPR: -49.5 dBc.

EDGE Features

- Typical EDGE performance, 1990 MHz, 26 V, $I_{DQ} = 400$ mA:
 - Output power (P_{OUT}): 18 W typical.
 - Power gain: 14.5 dB.
 - Efficiency: 35% typical.
 - Spectral regrowth:
 - @ ± 400 kHz = -62 dBc.
 - @ ± 600 kHz = -74 dBc.
 - Error vector magnitude (EVM) = 2.0%.

GSM Features

- Typical performance over entire GSM band:
 - P1dB: 50 W typical.
 - Power gain @ P1dB = 14.0 dB continuous wave (CW).
 - Efficiency @ P1dB = 54% typical CW.
 - Return loss: -10 dB.

Device Performance Features

- High-reliability, gold-metalization process.
- Low hot carrier injection (HCI) induced bias drift over 20 years.
- Internally matched.
- High gain, efficiency, and linearity.
- Integrated ESD protection.
- Device can withstand 10:1 voltage standing wave ratio (VSWR) at 28 Vdc, 1930 MHz, 45 W CW output power.
- Large signal impedance parameters available.

ESD Rating*

AGR19045EF	Minimum (V)	Class
HBM	500	1B
MM	50	A
CDM	1500	4

* Although electrostatic discharge (ESD) protection circuitry has been designed into this device, proper precautions must be taken to avoid exposure to ESD and electrical overstress (EOS) during all handling, assembly, and test operations. Agere employs a human-body model (HBM), a machine model (MM), and a charged-device model (CDM) qualification requirement in order to determine ESD-susceptibility limits and protection design evaluation. ESD voltage thresholds are dependent on the circuit parameters used in each of the models, as defined by JEDEC's JESD22-A114B (HBM), JESD22-A115A (MM), and JESD22-C101A (CDM) standards.

Caution: MOS devices are susceptible to damage from electrostatic charge. Reasonable precautions in handling and packaging MOS devices should be observed.

Electrical Characteristics

Table 1. Thermal Characteristics

Parameter	Symbol	Value	Unit
Thermal Resistance, Junction to Case	$R_{\theta JC}$	1.5	$^{\circ}\text{C}/\text{W}$

Table 2. Absolute Maximum Ratings*

Parameter	Symbol	Value	Unit
Drain-source Voltage	V_{DSS}	65	Vdc
Gate-source Voltage	V_{GS}	-0.5, 15	Vdc
Total Dissipation at $T_C = 25^{\circ}\text{C}$	P_D	115	W
Derate Above 25°C	—	0.67	$\text{W}/^{\circ}\text{C}$
Operating Junction Temperature	T_J	200	$^{\circ}\text{C}$
Storage Temperature Range	T_{STG}	-65, 150	$^{\circ}\text{C}$

* Stresses in excess of the absolute maximum ratings can cause permanent damage to the device. These are absolute stress ratings only. Functional operation of the device is not implied at these or any other conditions in excess of those given in the operational sections of the data sheet. Exposure to absolute maximum ratings for extended periods can adversely affect device reliability.

Recommended operating conditions apply unless otherwise specified: $T_C = 30^{\circ}\text{C}$.

Table 3. dc Characteristics

Parameter	Symbol	Min	Typ	Max	Unit
Off Characteristics					
Drain-source Breakdown Voltage ($V_{GS} = 0\text{ V}$, $I_D = 38\ \mu\text{A}$)	$V_{(BR)DSS}$	65	—	—	Vdc
Gate-source Leakage Current ($V_{GS} = 5\text{ V}$, $V_{DS} = 0\text{ V}$)	I_{GSS}	—	—	1.3	μA_{dc}
Zero Gate Voltage Drain Leakage Current ($V_{DS} = 28\text{ V}$, $V_{GS} = 0\text{ V}$)	I_{DSS}	—	—	4	μA_{dc}
On Characteristics					
Forward Transconductance ($V_{DS} = 10\text{ V}$, $I_D = 0.4\text{ A}$)	G_{FS}	—	3.0	—	S
Gate Threshold Voltage ($V_{DS} = 10\text{ V}$, $I_D = 130\ \mu\text{A}$)	$V_{GS(TH)}$	—	—	4.8	Vdc
Gate Quiescent Voltage ($V_{DS} = 28\text{ V}$, $I_D = 400\text{ mA}$)	$V_{GS(Q)}$	—	3.7	—	Vdc
Drain-source On-voltage ($V_{GS} = 10\text{ V}$, $I_D = 0.4\text{ A}$)	$V_{DS(ON)}$	—	0.3	—	Vdc

Electrical Characteristics (continued)

Recommended operating conditions apply unless otherwise specified: Tc = 30 °C.

Table 4. RF Characteristics

Parameter	Symbol	Min	Typ	Max	Unit
Dynamic Characteristics					
Reverse Transfer Capacitance (V _{DS} = 28 V, V _{GS} = 0, f = 1.0 MHz) (This part is internally matched on both the input and output.)	CRSS	—	1.0	—	pF
Functional Tests (in Agere Systems Supplied Test Fixture)					
Common-source Amplifier Power Gain (V _{DD} = 28 Vdc, P _{OUT} = 9 W average, 2-Carrier N-CDMA, I _{DQ} = 550 mA, f ₁ = 1930 MHz, f ₂ = 1932.5 MHz and f ₁ = 1987.5 MHz, f ₂ = 1990 MHz)	GPS	14.5	15.0	—	dB
Drain Efficiency (V _{DD} = 28 Vdc, P _{OUT} = 9 W average, 2-Carrier N-CDMA, I _{DQ} = 550 mA, f ₁ = 1930 MHz, f ₂ = 1932.5 MHz and f ₁ = 1987.5 MHz, f ₂ = 1990 MHz)	η	—	24.8	—	%
Third-order Intermodulation Distortion (V _{DD} = 28 Vdc, P _{OUT} = 9 W average, 2-Carrier N-CDMA, I _{DQ} = 550 mA, f ₁ = 1930 MHz, f ₂ = 1932.5 MHz and f ₁ = 1987.5 MHz, f ₂ = 1990 MHz; IM3 measured in a 1.228 MHz integration bandwidth centered at f ₁ – 2.5 MHz and f ₂ + 2.5 MHz, referenced to the carrier channel power)	IM3	—	–34.5	—	dBc
Adjacent Channel Power Ratio (V _{DD} = 28 Vdc, P _{OUT} = 9 W average, 2-Carrier N-CDMA, I _{DQ} = 550 mA, f ₁ = 1930 MHz, f ₂ = 1932.5 MHz and f ₁ = 1987.5 MHz, f ₂ = 1990 MHz; ACPR measured in a 30 kHz integration bandwidth centered at f ₁ – 885 kHz and f ₂ + 885 kHz, referenced to the carrier channel power)	ACPR	—	–49.5	—	dBc
Input Return Loss (V _{DD} = 28 Vdc, P _{OUT} = 9 W average, 2-Carrier N-CDMA, I _{DQ} = 550 mA, f ₁ = 1930 MHz, f ₂ = 1932.5 MHz and f ₁ = 1987.5 MHz, f ₂ = 1990 MHz)	IRL	—	–10	—	dB
Output Power at 1 dB Gain Compression (V _{DD} = 28 V, P _{OUT} = 45 W CW, f = 1990 MHz, I _{DQ} = 400 mA)	P1dB	45	50	—	W
Ruggedness (V _{DD} = 28 V, P _{OUT} = 45 W CW, I _{DQ} = 400 mA, f = 1930 MHz, VSWR = 10:1 [all phase angles])	Ψ	No degradation in output power.			

Test Circuit Illustrations for AGR19045EF

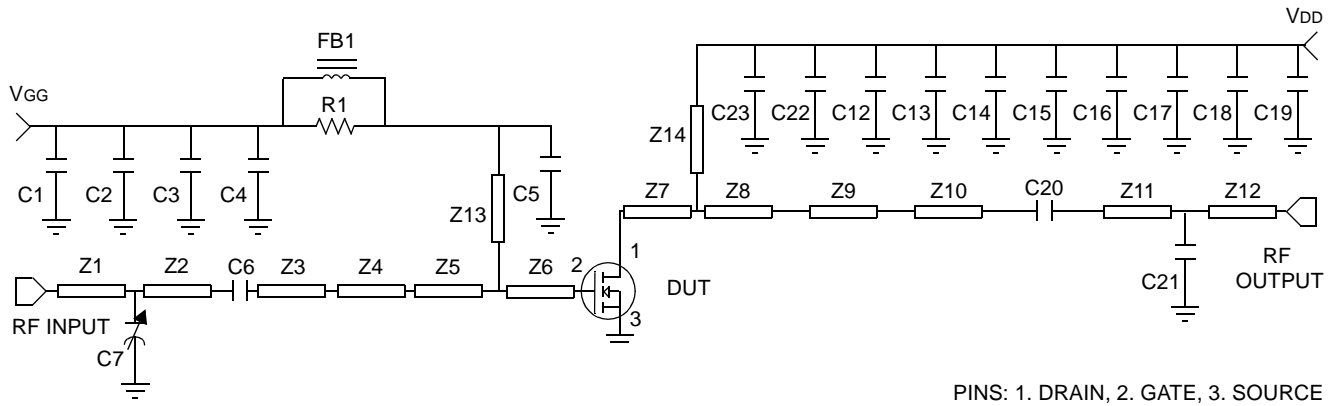

A. Schematic

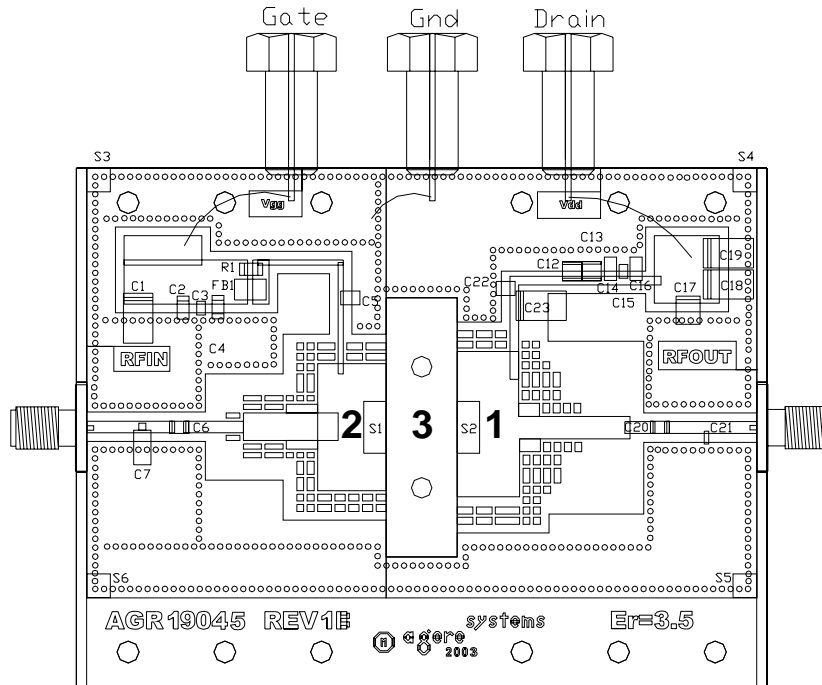

B. Component Layout

Parts List:

- Microstrip line: Z1, 0.320 in. x 0.067 in.; Z2, 0.185 in. x 0.067 in.; Z3, 0.345 in. x 0.067 in.; Z4, 0.250 in. x 0.160 in.; Z5, 0.180 in. x 0.260 in.; Z6, 0.400 in. x 0.735 in.; Z7, 0.355 in. x 0.840 in.; Z8, 0.120 in. x 0.280 in.; Z9, 0.525 in. x 0.130 in.; Z10, 0.145 in. x 0.067 in.; Z11, 0.245 in. x 0.067 in.; Z12, 0.290 in. x 0.067 in.; Z13, 0.370 in. x 0.030 in.; Z14, 0.280 in. x 0.050 in.
- ATC® B case chip capacitors: C5, C12, C22: 8.2 pF; C6, C20: 10 pF; C13: 1000 pF.
- ATC S case chip capacitor: C21: 0.2 pF
- Kemet® B case chip capacitors: C2, C16: 0.1 μF CDR33BX104AKWS. Tantalum capacitor: C17, 1 μF, 50 V, T491C.
- Vitramon® 1206: C4, C14: 22000 μF.
- Johanson Giga-Trim® variable capacitor C7: 0.4 pF—2.5 pF.
- Murata® 0805: C3, C15: 0.01 μF, GRM40X7R103K100AL.
- Sprague® tantalum surface-mount chip capacitor: C1, C18, C19, C23: 22 μF, 35 V.
- Fair-Rite® ferrite bead: FB1: 2743019447.
- Fixed film chip resistor: R1: 12 Ω, 0.25 W, 0.08 x 0.13.
- PCB etched circuit boards.
- Taconic® ORCER RF-35: board material, 1 oz. copper, 30 mil thickness, $\epsilon_r = 3.5$.

Figure 2. AGR19045EF Test Circuit

Typical Performance Characteristics

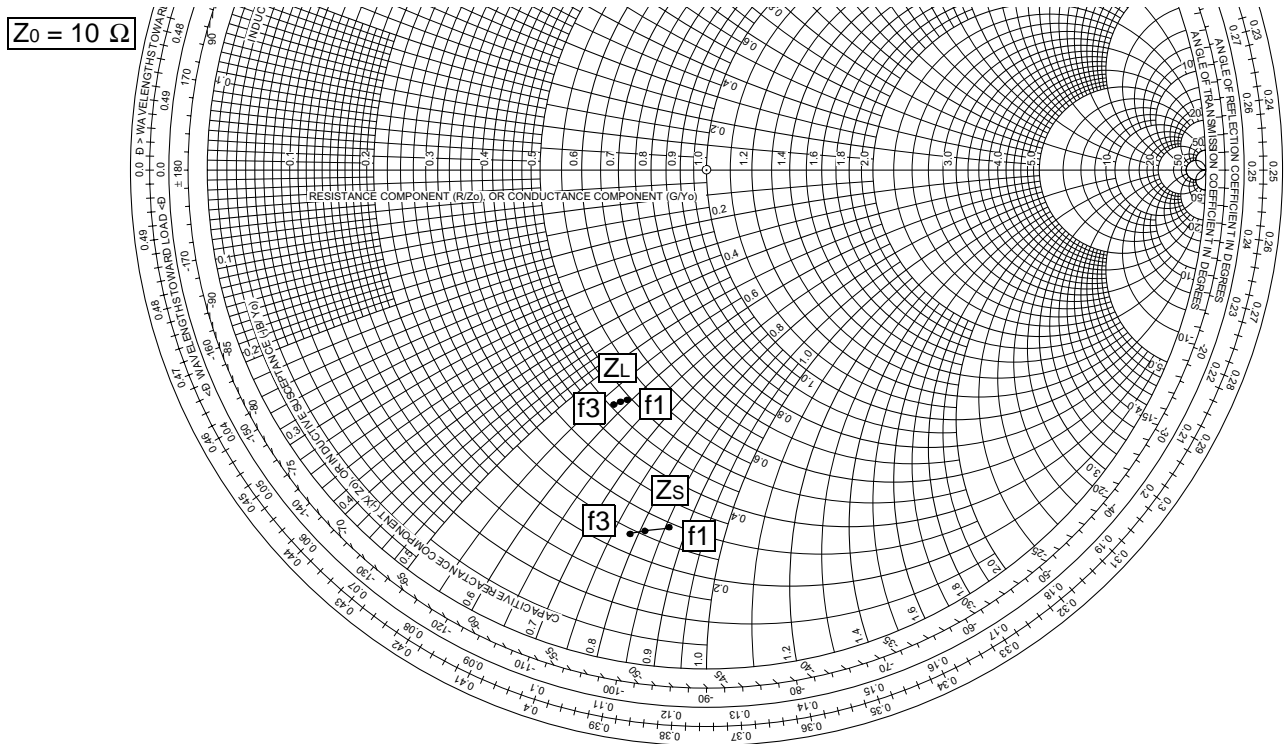

MHz (f)	Zs Ω (Complex Source Impedance)	ZL Ω (Complex Optimum Load Impedance)
1930 (f1)	2.79 – j8.63	4.94 – j6.00
1960 (f2)	2.64 – j8.20	4.82 – j5.91
1990 (f3)	2.38 – j7.78	4.47 – j5.79

Note: ZL was chosen based on trade-offs between gain, output power, drain efficiency, and intermodulation distortion.

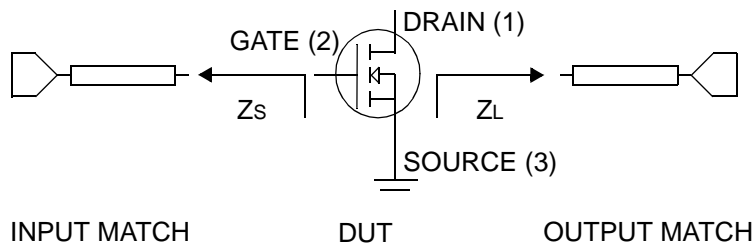
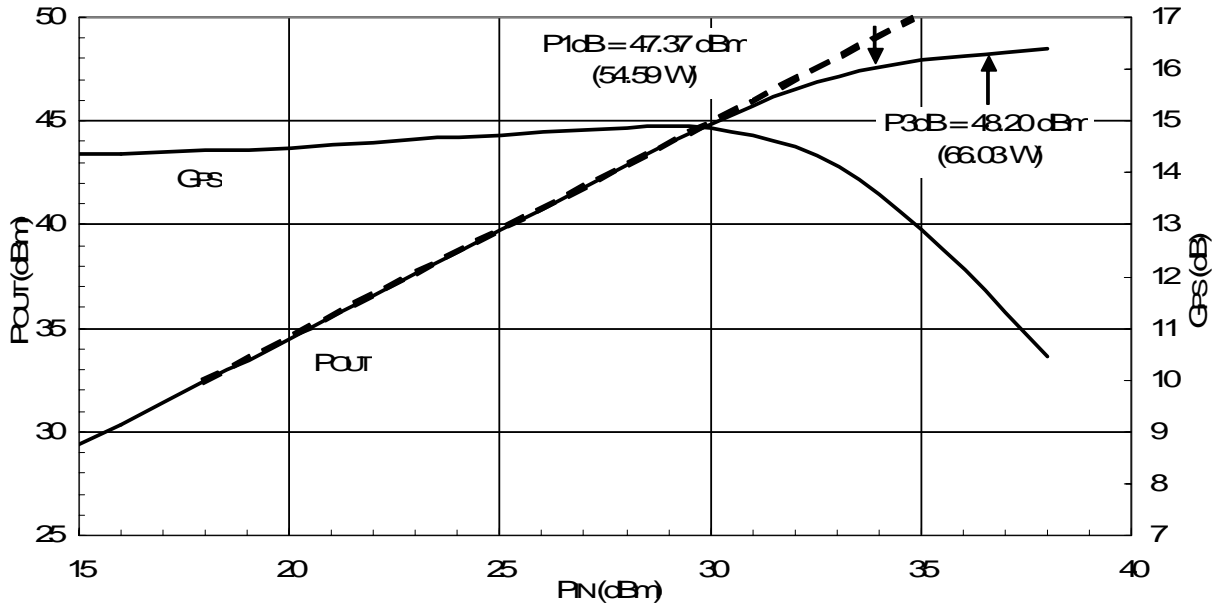

Figure 3. Series Equivalent Input and Output Impedances

Typical Performance Characteristics (continued)



Test Conditions:
 $V_{DD} = 28$ Vdc, $I_{DQ} = 400$ mA, CW center frequency = 1960 MHz.

Figure 4. CW P_{OUT} vs. P_{IN}

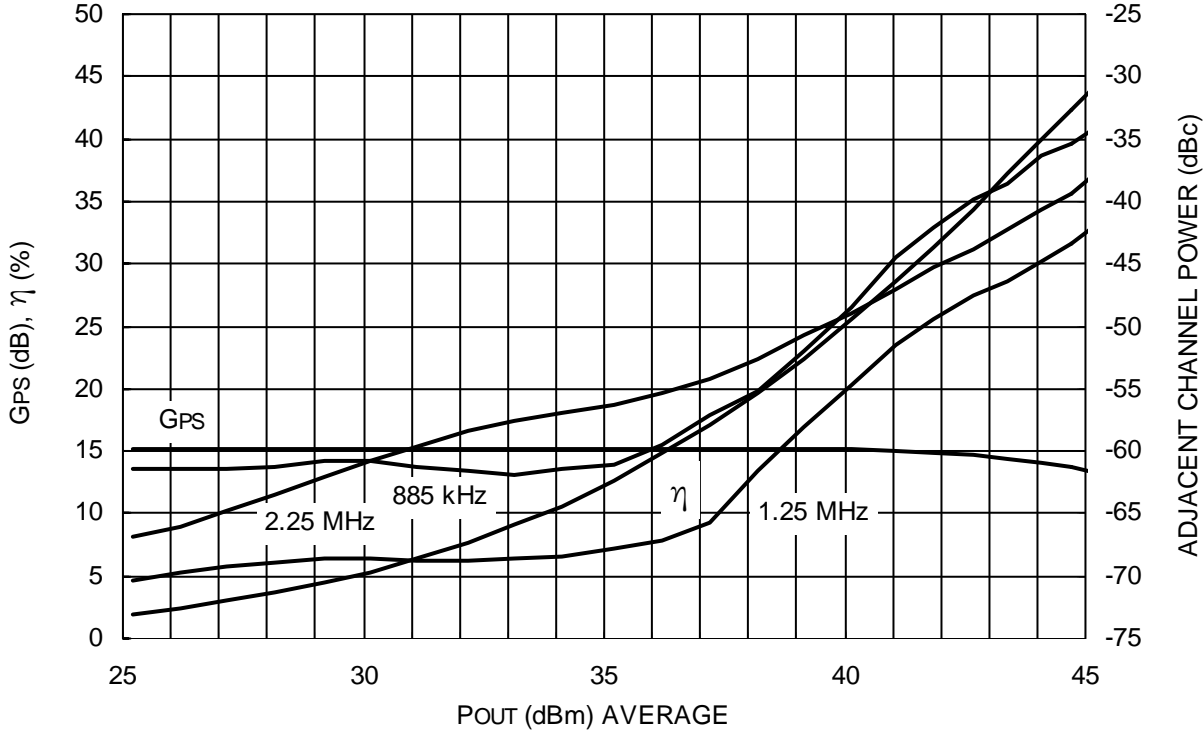

Test Conditions:
 $V_{DD} = 28$ V, $I_{DQ} = 550$ mA, $f_1 = 1960$ MHz, N-CDMA, 2.5 MHz @ 1.2288 MHz bandwidth. Peak/Average = 9.72 dB @ 0.01% probability (CCDF). Channel spacing (bandwidth): 885 kHz (30 kHz), 1.25 MHz (12.5 kHz), 2.25 MHz (1 MHz).

Figure 5. N-CDMA ACPR, Power Gain, and Drain Efficiency vs. Power

Typical Performance Characteristics (continued)

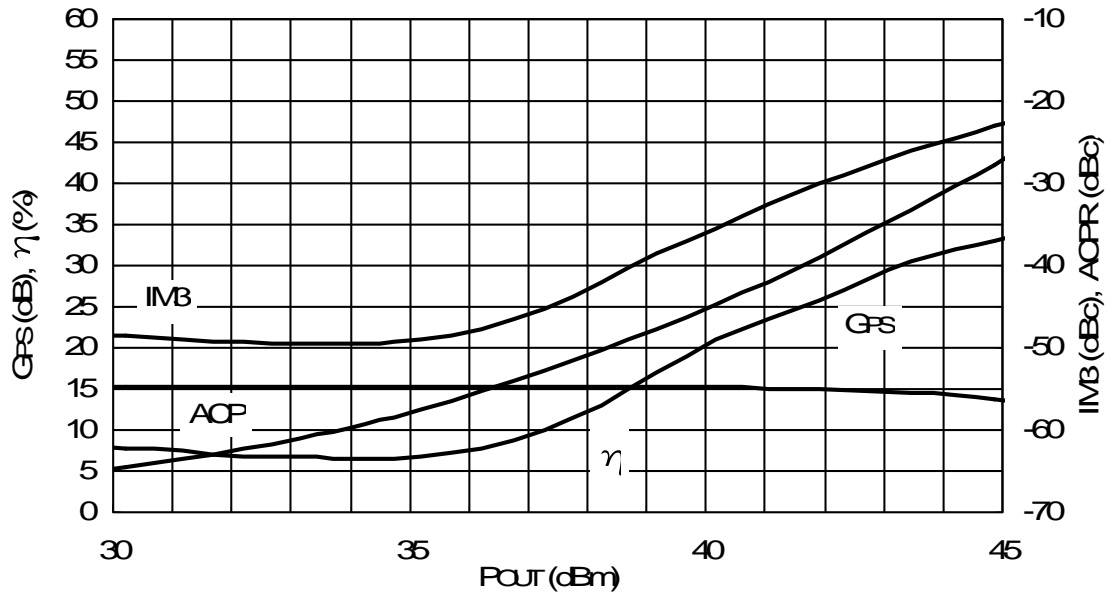

Test Conditions:

V_{DD} = 28 V, I_{DQ} = 550 mA, f₁ = 1958.75 MHz, f₂ = 1961.25 MHz, 2 x N-CDMA, 2.5 MHz @ 1.2288 MHz bandwidth. Peak/average = 9.72 dB @ 0.01% probability (CCDF). Channel spacing (bandwidth); ACPR: 885 kHz (30 kHz), IM3: 2.5 MHz (1.2288 MHz).

Figure 6. 2-Carrier N-CDMA ACPR, IM3, Power Gain, and Drain Efficiency vs. Power

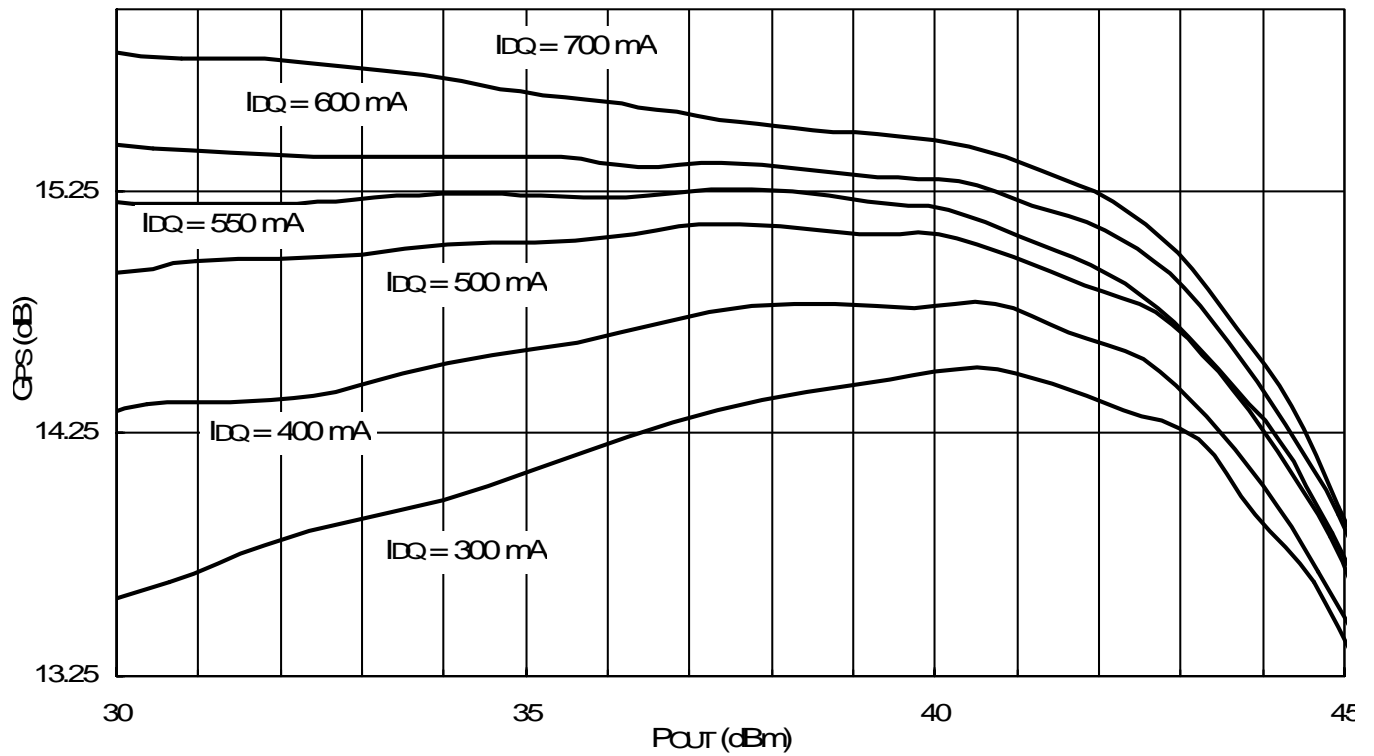

Test Conditions:

V_{DD} = 28 Vdc, f₁ = 1958.75 MHz, f₂ = 1961.25 MHz, 2-carrier N-CDMA measurement.

Figure 7. 2-Carrier N-CDMA, GPs vs. Pout

Typical Performance Characteristics (continued)

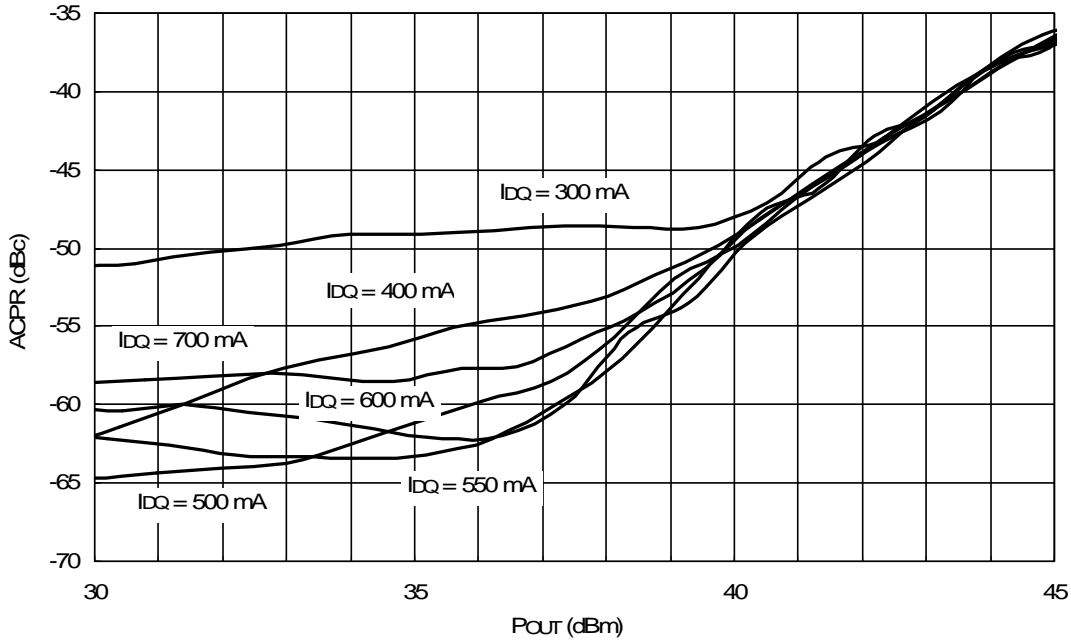

Test Conditions:
VDD = 28 Vdc, f1 = 1958.75 MHz, f2 = 1961.25 MHz, 2-carrier N-CDMA measurement.

Figure 8. ACPR vs. Pout

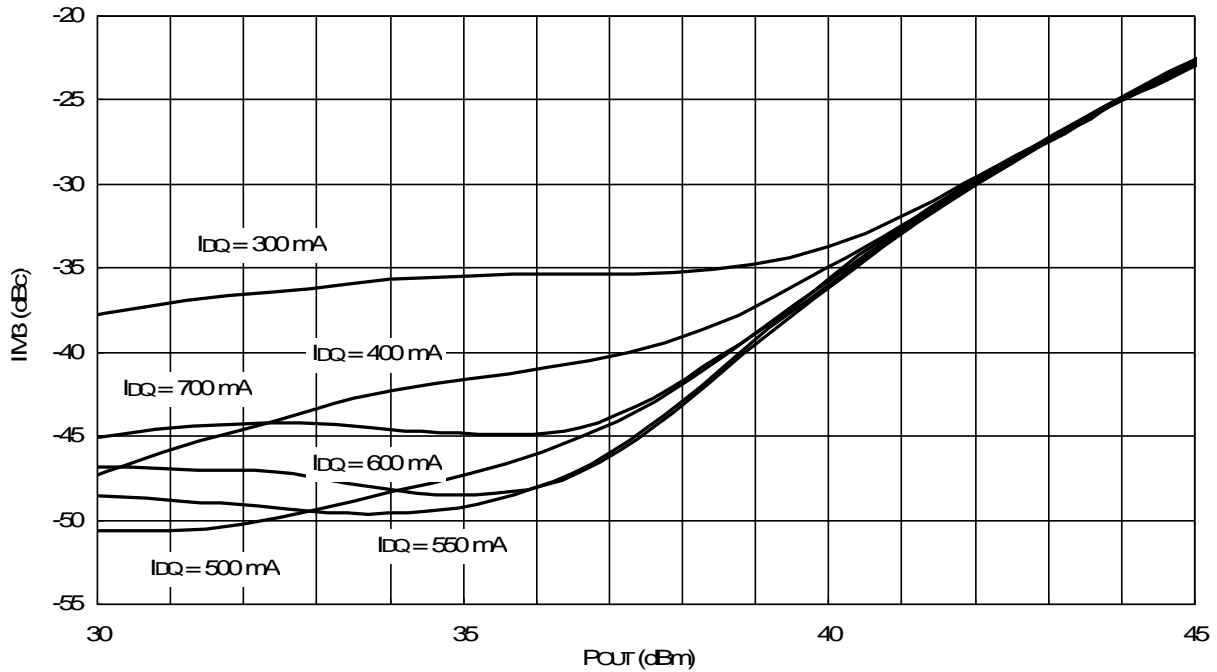

Test Conditions:
VDD = 28 Vdc, f1 = 1958.75 MHz, f2 = 1961.25 MHz, 2-carrier N-CDMA measurement.

Figure 9. IM3 vs. Pout

Typical Performance Characteristics (continued)

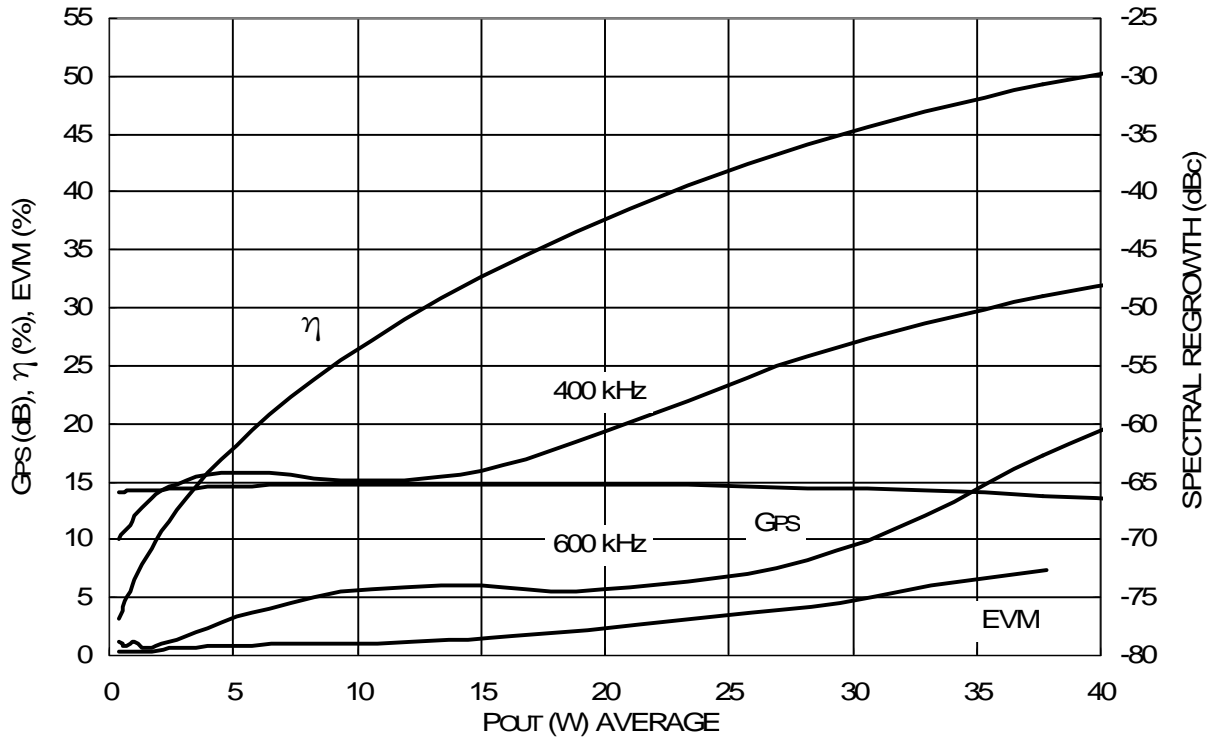

Test Conditions:
VDD = 26 Vdc, Idq = 400 mA, f = 1960 MHz, modulation = GSM/EDGE.

Figure 10. GSM/EDGE Power Gain, Drain Efficiency, Spectral Regrowth, and EVM Average vs. Pout

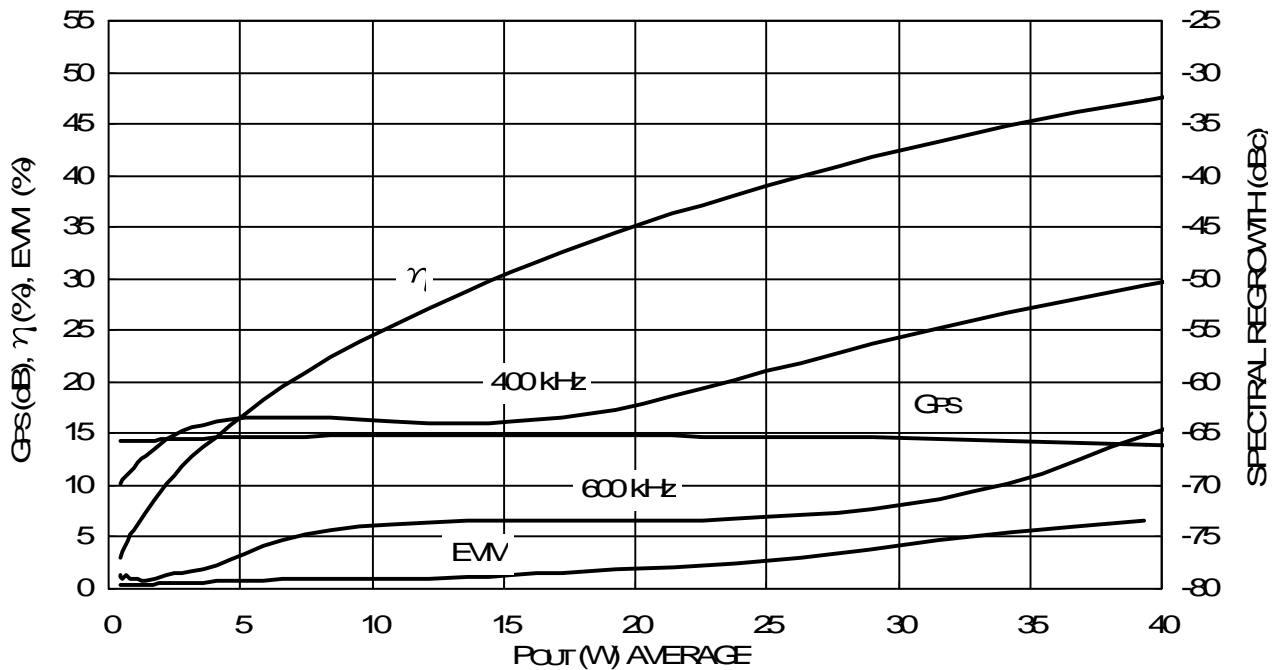

Test Conditions:
VDD = 28 Vdc, Idq = 400 mA, f = 1960 MHz, modulation = GSM/EDGE.

Figure 11. GSM/EDGE Power Gain, Drain Efficiency, Spectral Regrowth, and EVM Average vs. Pout

Package Dimensions

All dimensions are in inches. Tolerances are ± 0.005 in. unless specified.

AGR19045EF

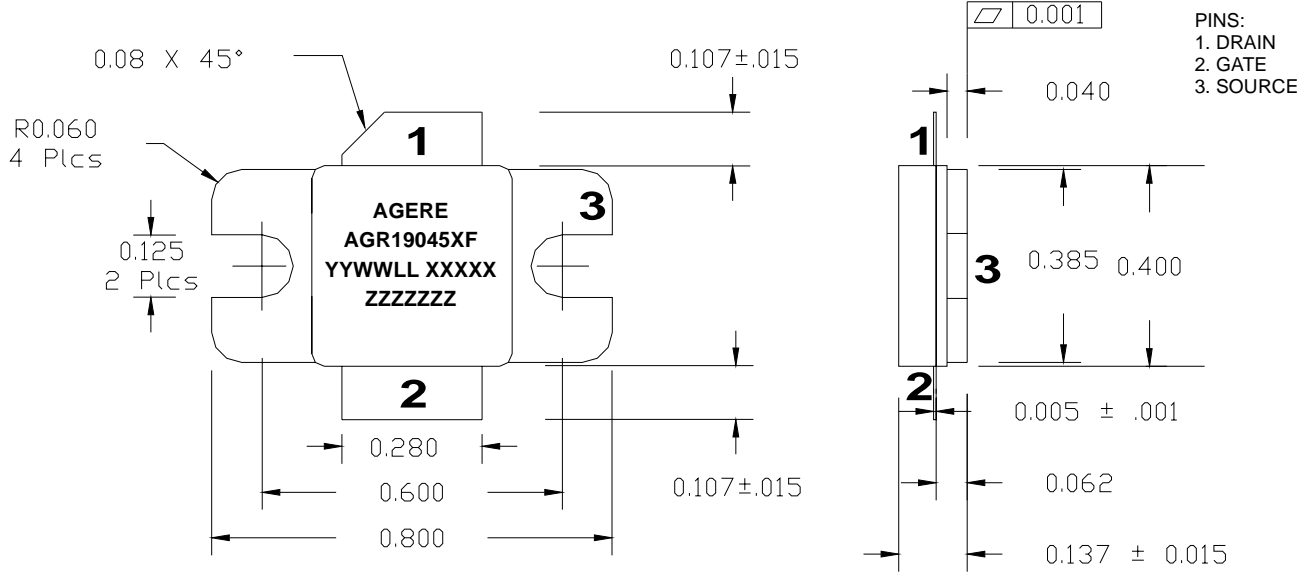

Label Notes:

- M before the part number denotes model program. X before the part number denotes engineering prototype.
- The last two letters of the part number denote wafer technology and package type.
- YYWWLL is the date code including place of manufacture: year year work week (YYWW), LL = location (AL = Allentown, PA; T = Thailand). XXXXX = five-digit wafer lot number.
- ZZZZZZZ = seven-digit assembly lot number on production parts.
- ZZZZZZZZZZZZ = 12-digit (five-digit lot, two-digit wafer, and five-digit serial number) on models and engineering prototypes.

RF Power Product Information

For product and application information, please visit our website: <http://www.agere.com/rfpower>.

ATC is a registered trademark of American Technical Ceramics Corp.
Kemet is a registered trademark of KRC Trade Corporation.
Vitramon is a registered trademark of Vitramon Incorporated.
Sprague is a registered trademark of Sprague Electric Company Corporation.
Murata is a registered trademark of Murata Electronics North America, Inc.
Johanson and *Giga-Trim* are registered trademarks of Johanson Manufacturing Corporation.
Fair-Rite is a registered trademark of Fair-Rite Products Corporation.
Taconic is a registered trademark of Tonoga Limited DBA Taconic Plastics Ltd.

For additional information, contact your Agere Systems Account Manager or the following:

INTERNET: <http://www.agere.com>

E-MAIL: docmaster@agere.com

N. AMERICA: Agere Systems Inc., Lehigh Valley Central Campus, Room 10A-301C, 1110 American Parkway NE, Allentown, PA 18109-9138

1-800-372-2447, FAX 610-712-4106 (In CANADA: **1-800-553-2448**, FAX 610-712-4106)

ASIA: CHINA: **(86) 21-54614688** (Shanghai), **(86) 755-25881122** (Shenzhen)

JAPAN: **(81) 3-5421-1600** (Tokyo), KOREA: **(82) 2-767-1850** (Seoul), SINGAPORE: **(65) 6778-8833**, TAIWAN: **(886) 2-2725-5858** (Taipei)

EUROPE: **Tel. (44) 1344 296 400**

Agere Systems Inc. reserves the right to make changes to the product(s) or information contained herein without notice. No liability is assumed as a result of their use or application.
Agere is a registered trademark of Agere Systems Inc. Agere Systems and the Agere logo are trademarks of Agere Systems Inc.